

# 01. FORE SHROUDS, TOP MAST SHROUDS & TOP GALLANT SHROUDS

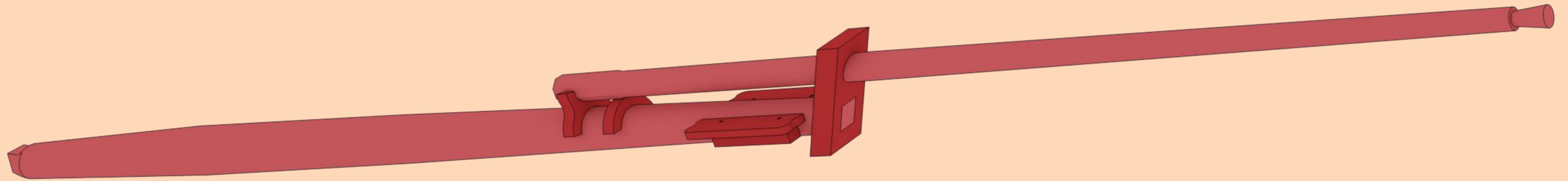

# 01. FORE MAST

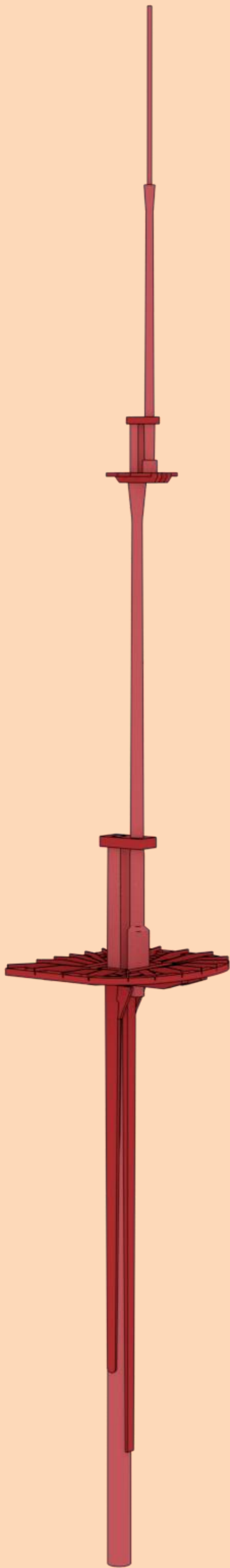
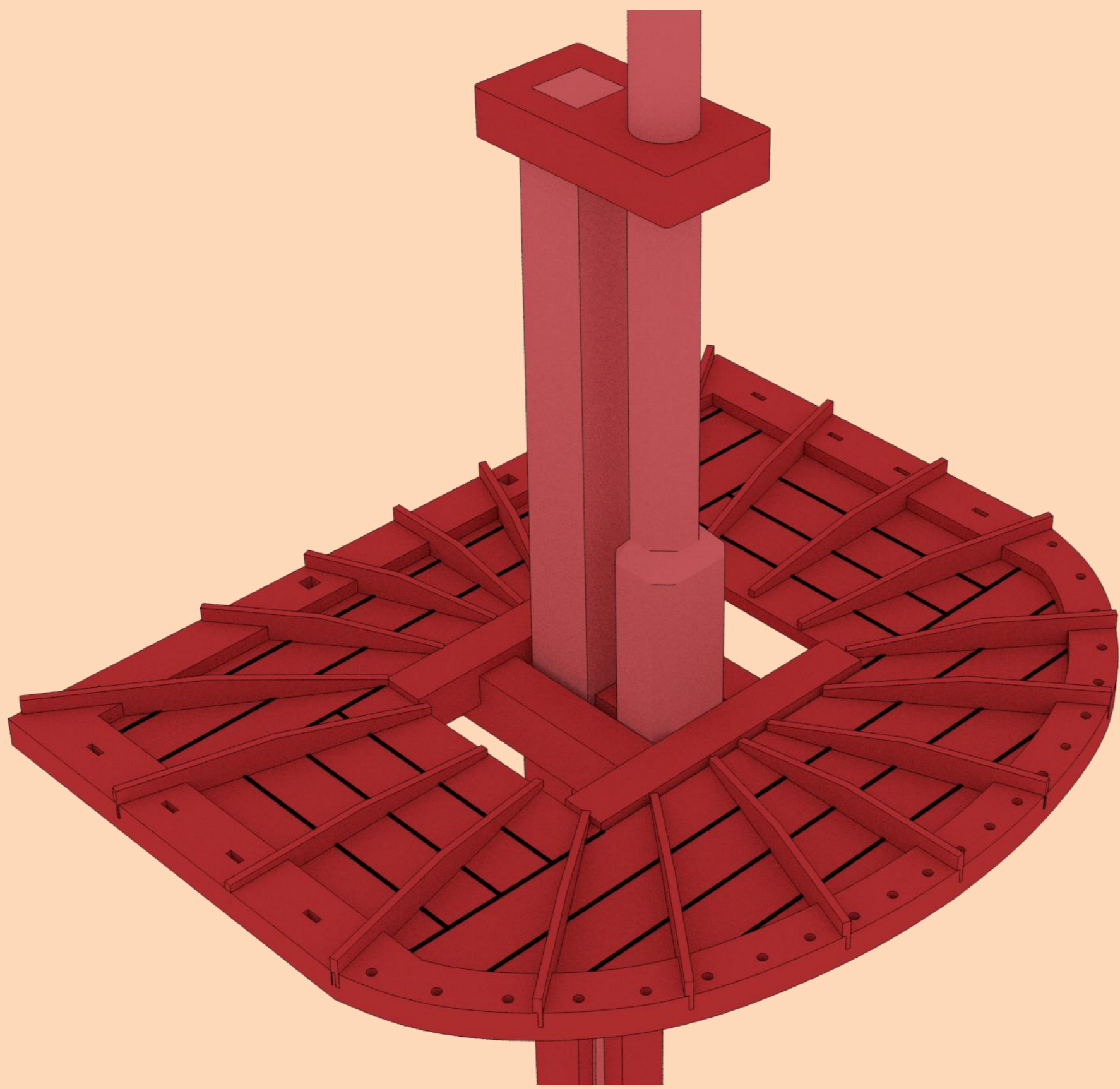
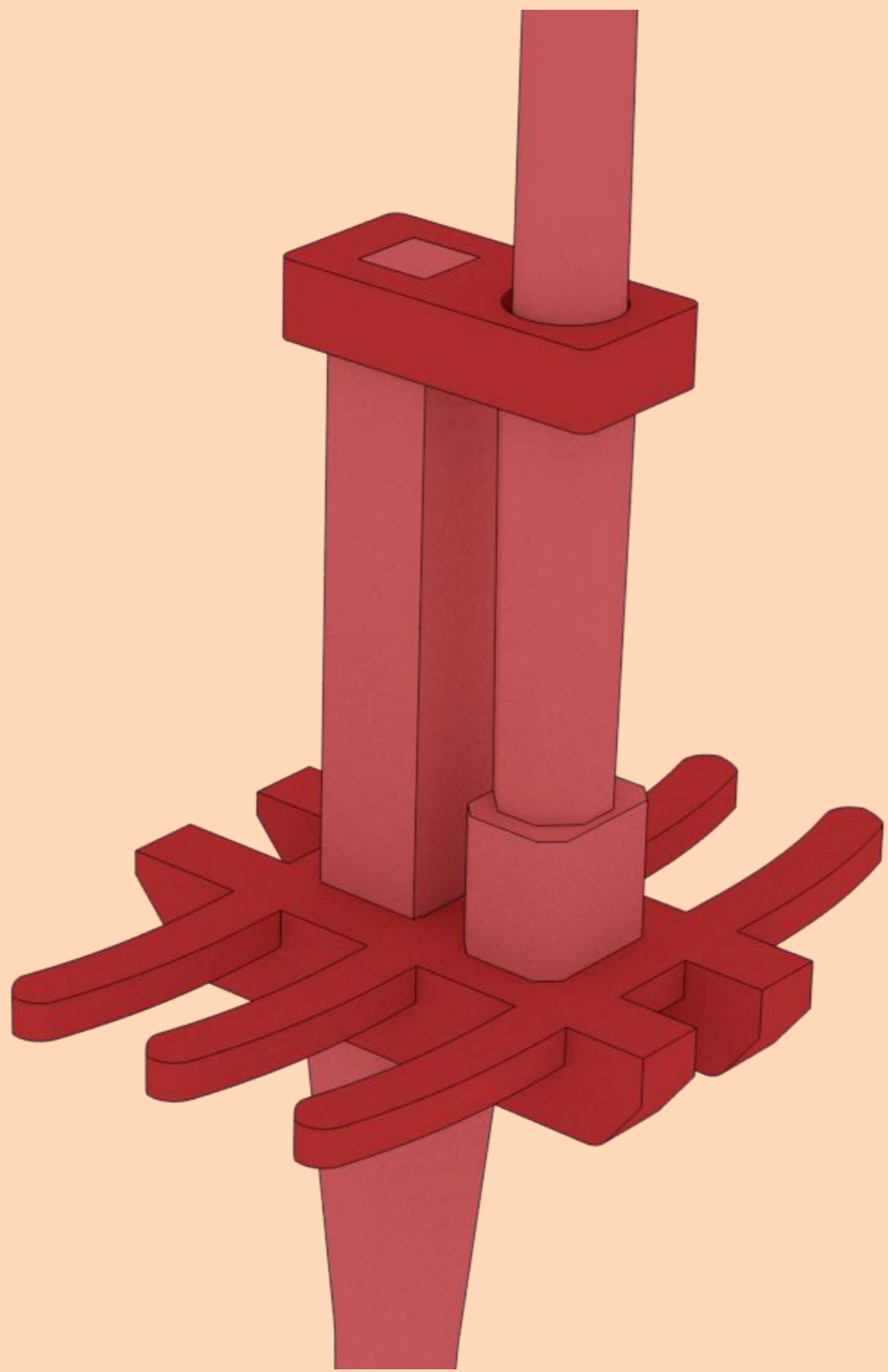

# 01. MAIN MAST

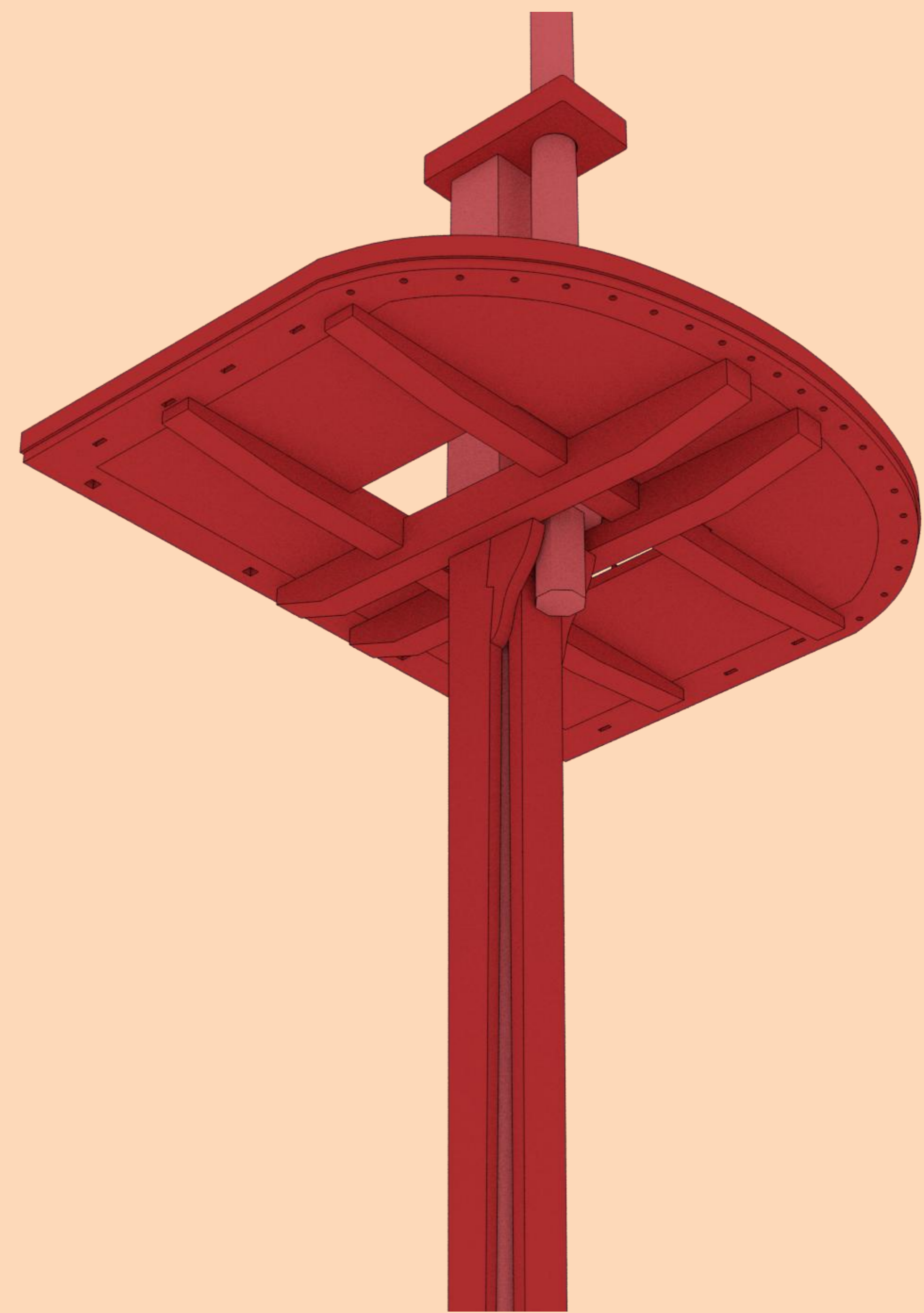
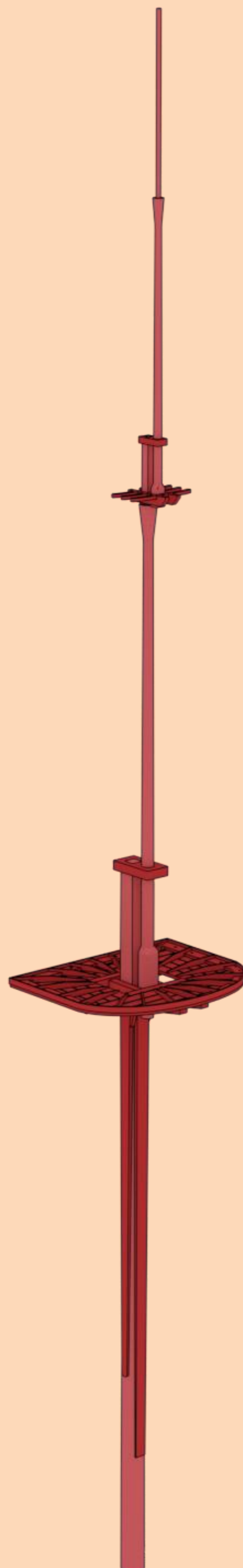
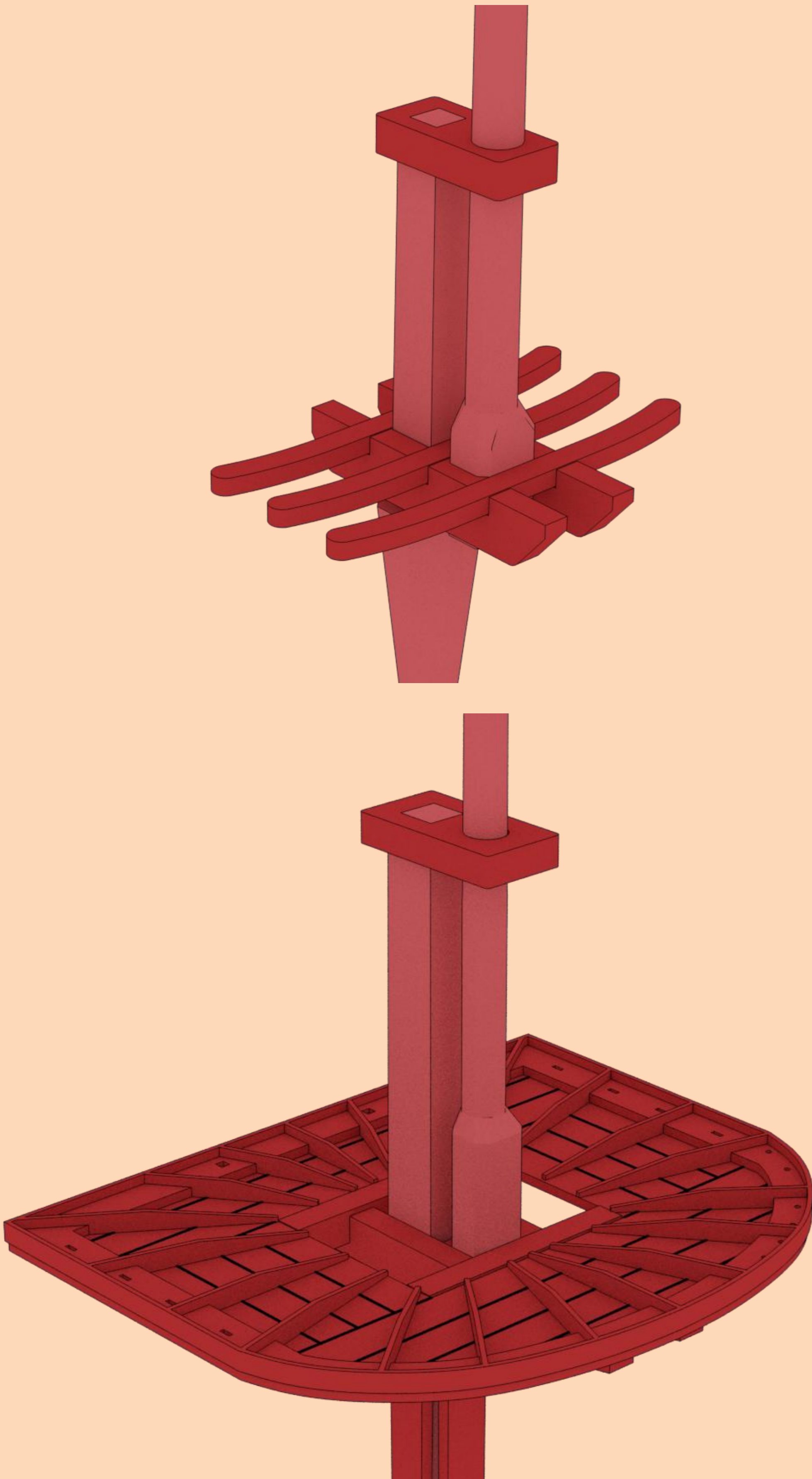

# 01. MIZZEN MAST

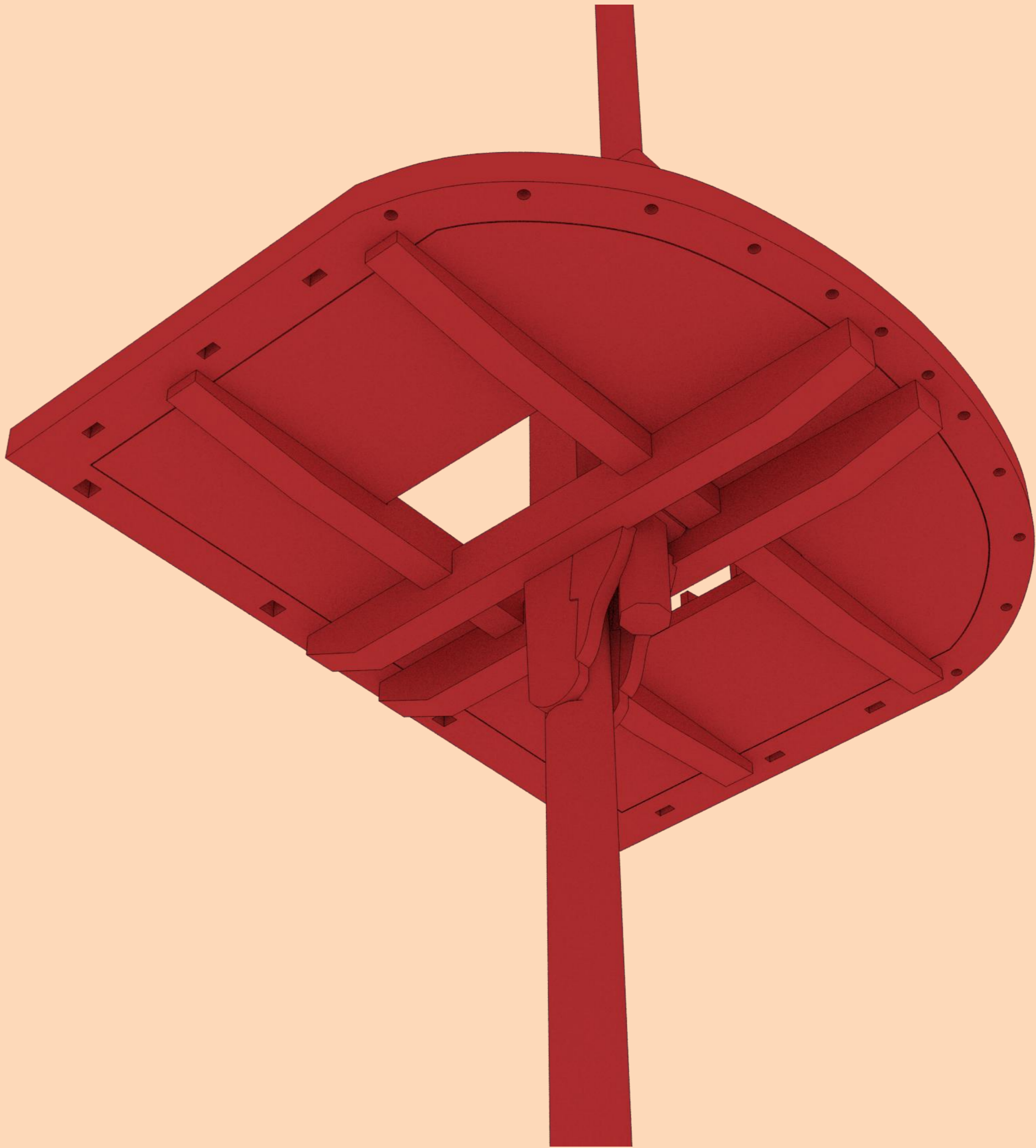
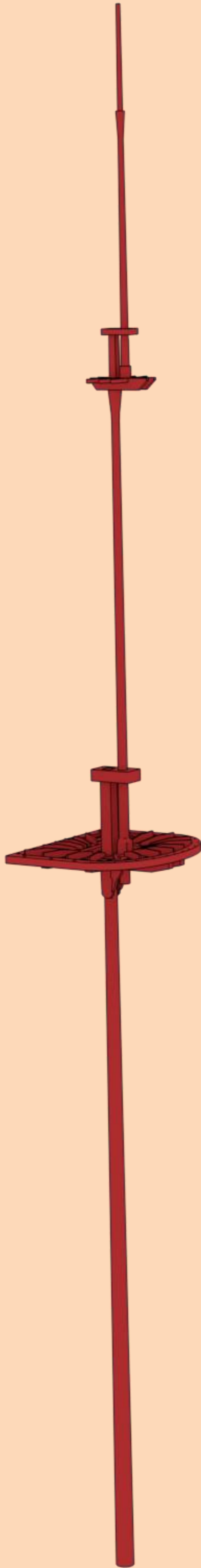
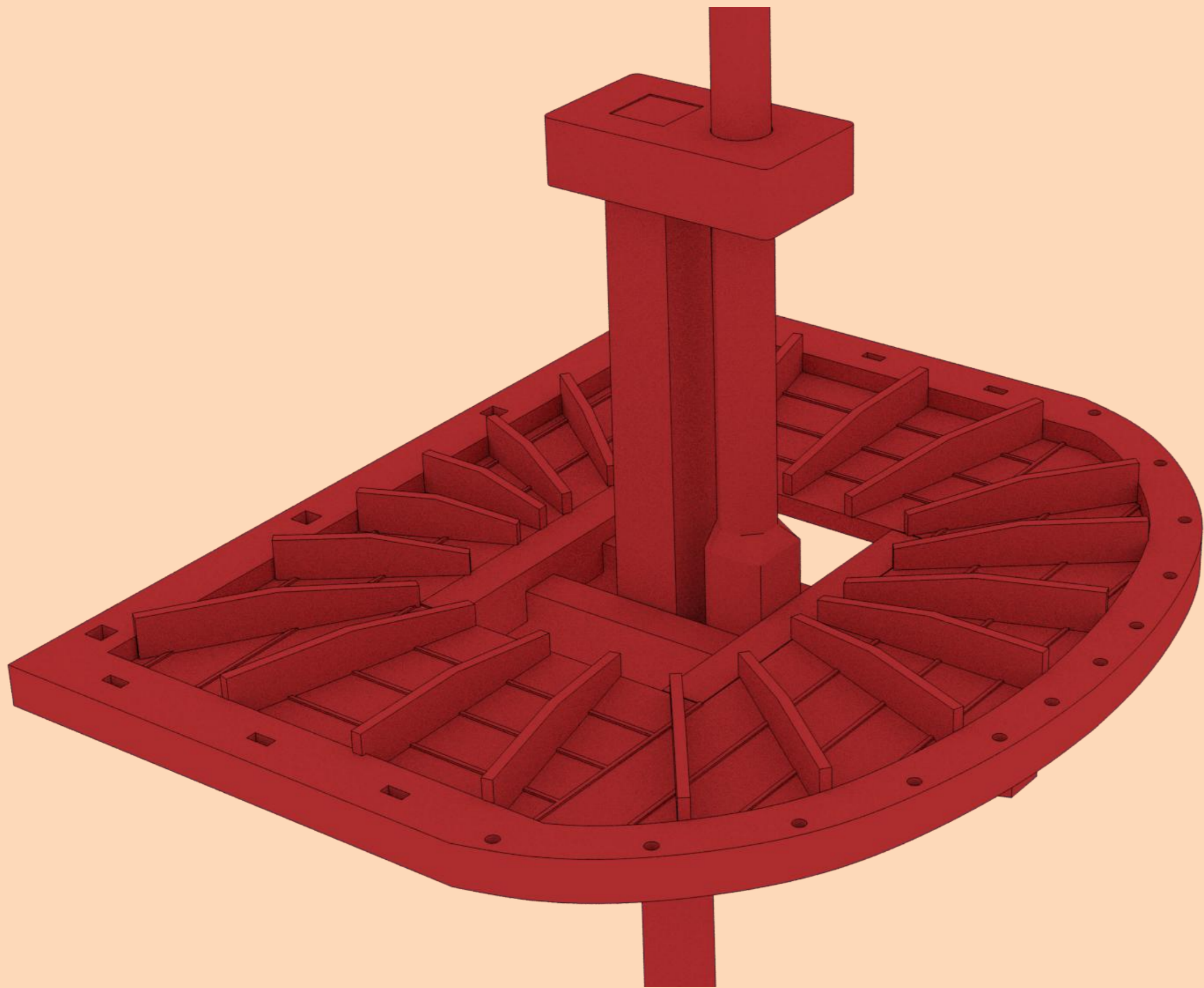
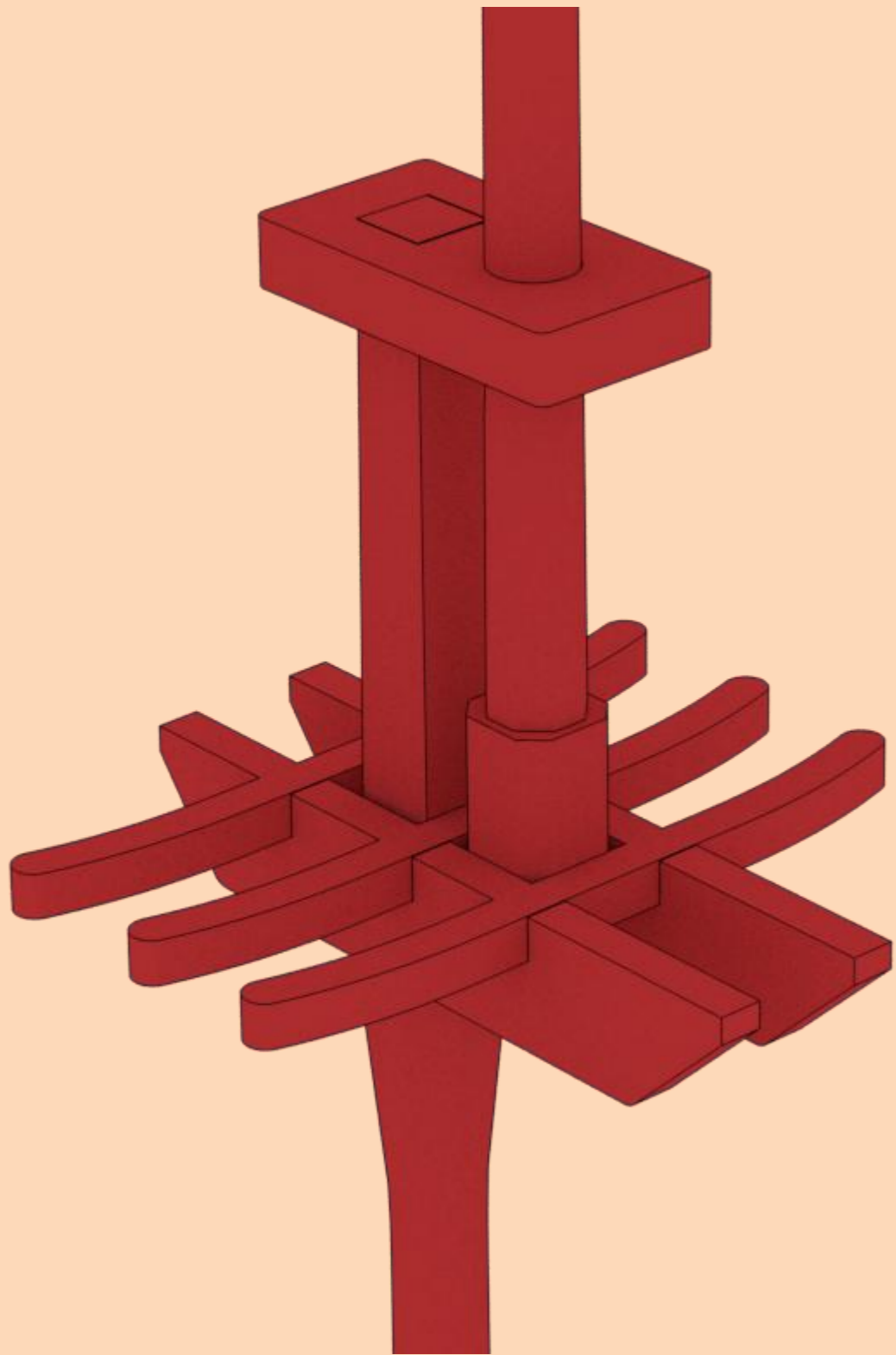

# 01. FORE SHROUDS, TOP MAST SHROUDS & TOP GALLANT SHROUDS

## SIDE & FRONT VIEW

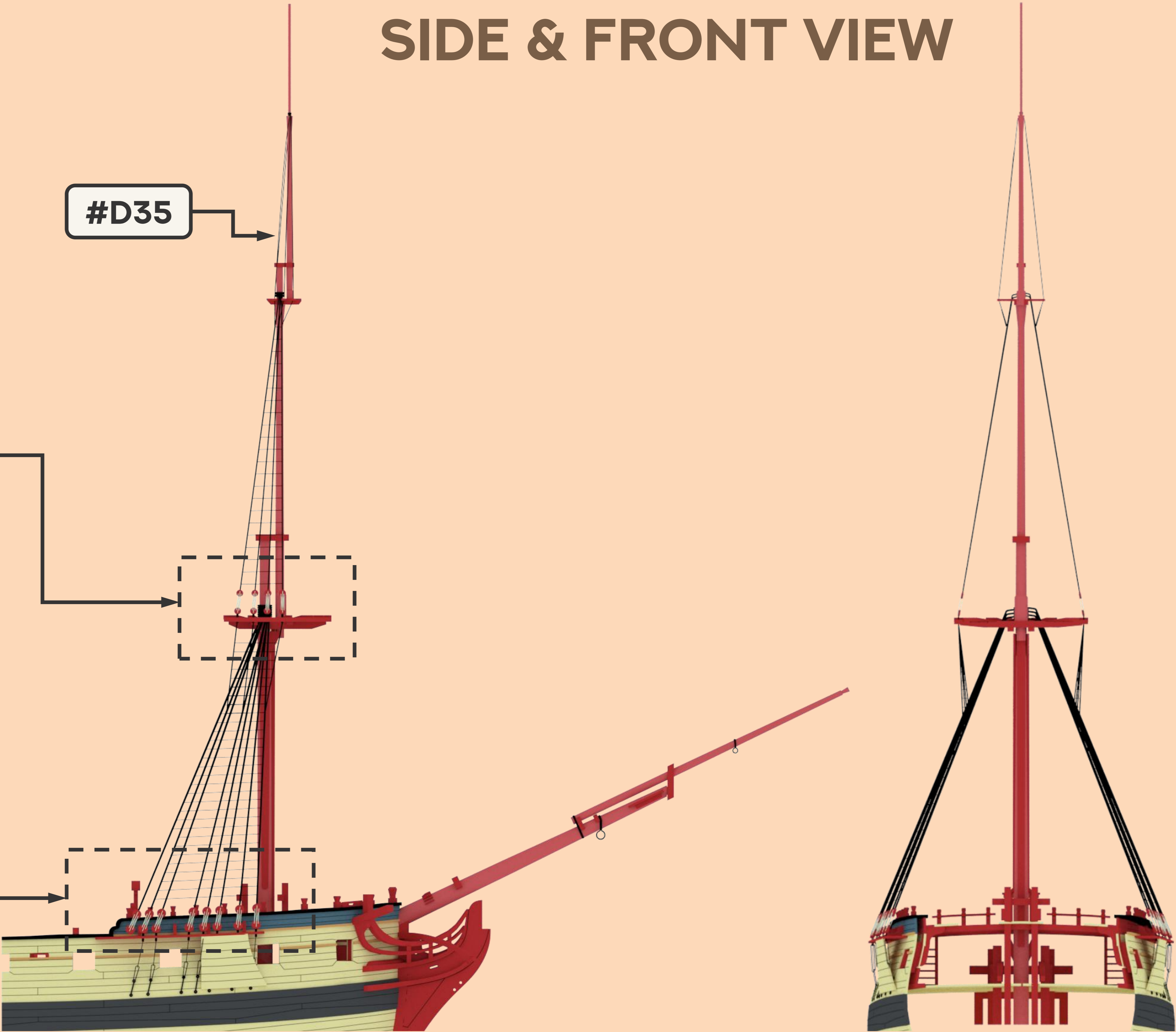
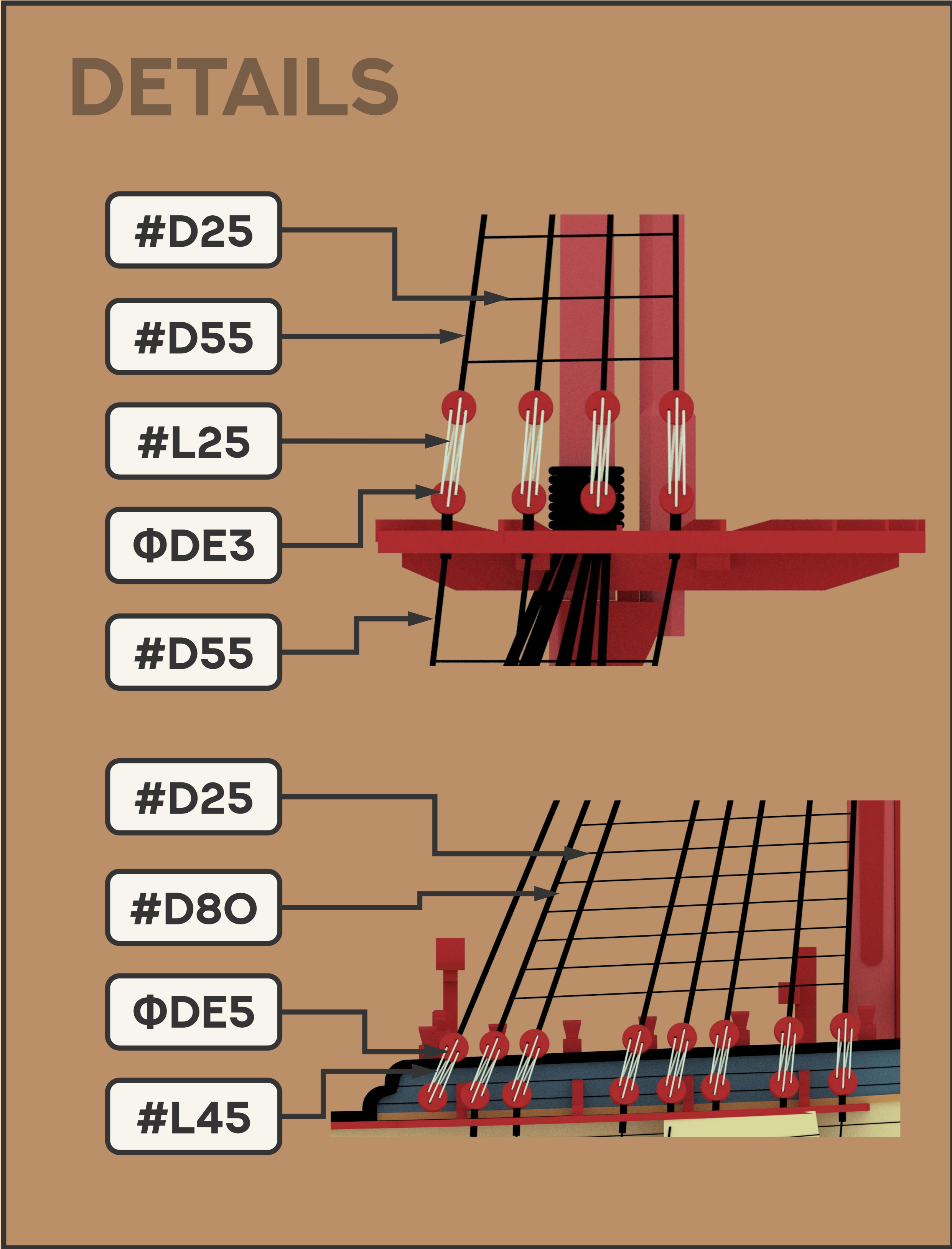

# 01. FORE SHROUDS, TOP MAST SHROUDS & TOP GALLANT SHROUDS

## STEPS:

- 1, First tie the shrouds at the fore lower trees in pairs, attach 5mm deadeye at the end. Then make the lanyards using 0.45mm light thread, and finally add the ratlines with the aid of the paper template.
- 2, Make the top mast shrouds in the same way as the lower shrouds, but using 3mm deadeye and 0.25mm light thread. Don't forget to make the futtock shrouds and ratlines using 0.55mm and 0.25mm dark thread.
- 3, Make the top-gallant shrouds, please note that there won't be ratlines for these.

# O2. MAIN SHROUDS, TOP MAST SHROUDS & TOP GALLANT SHROUDS

## SIDE & FRONT VIEW

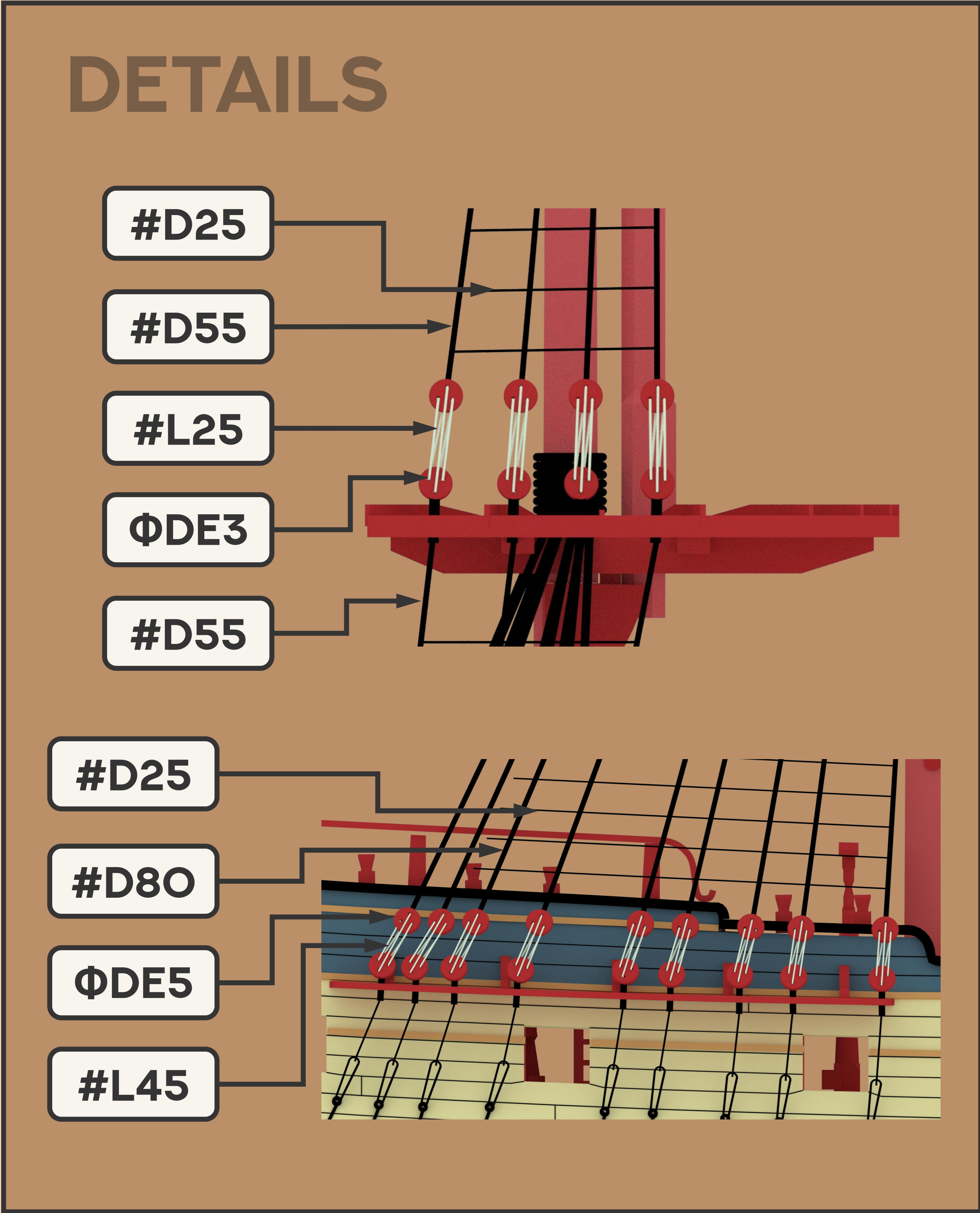

#D35

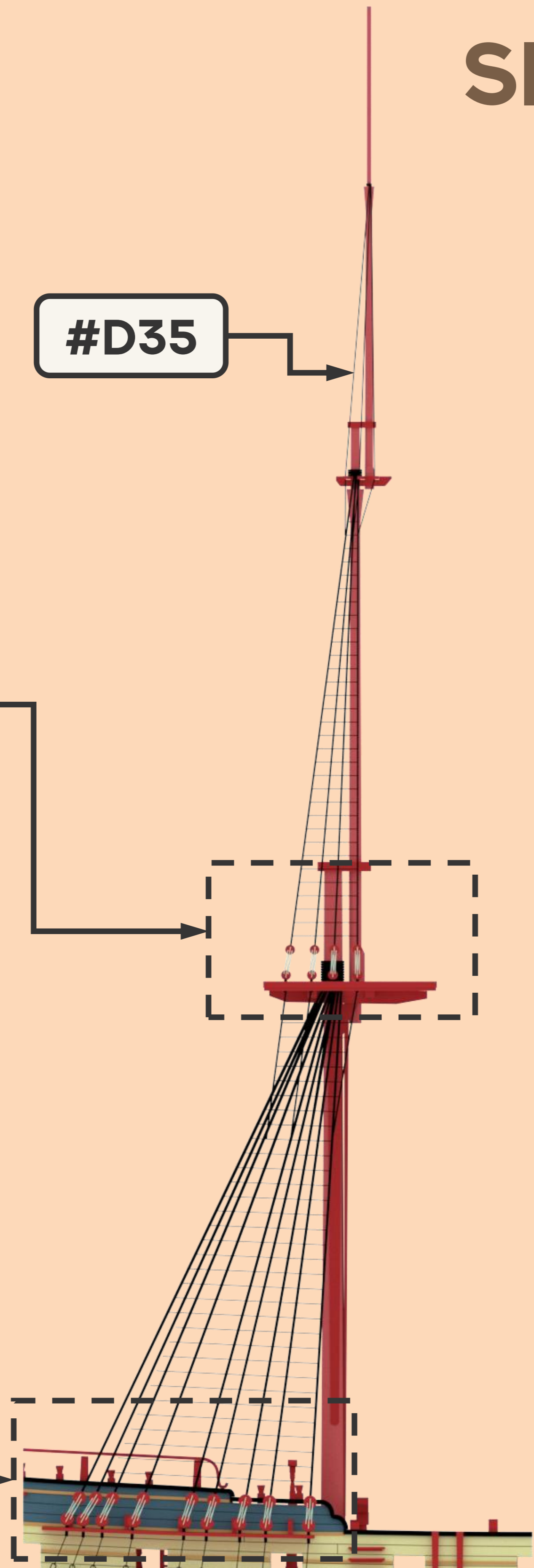

# O3. MIZZEN SHROUDS, TOP MAST SHROUDS & TOP GALLANT SHROUDS

## SIDE & FRONT VIEW

### DETAILS

- #D25
- #D35
- #L25
- ΦDE3
- #D35
- #D25
- #D55
- ΦDE4
- #L25

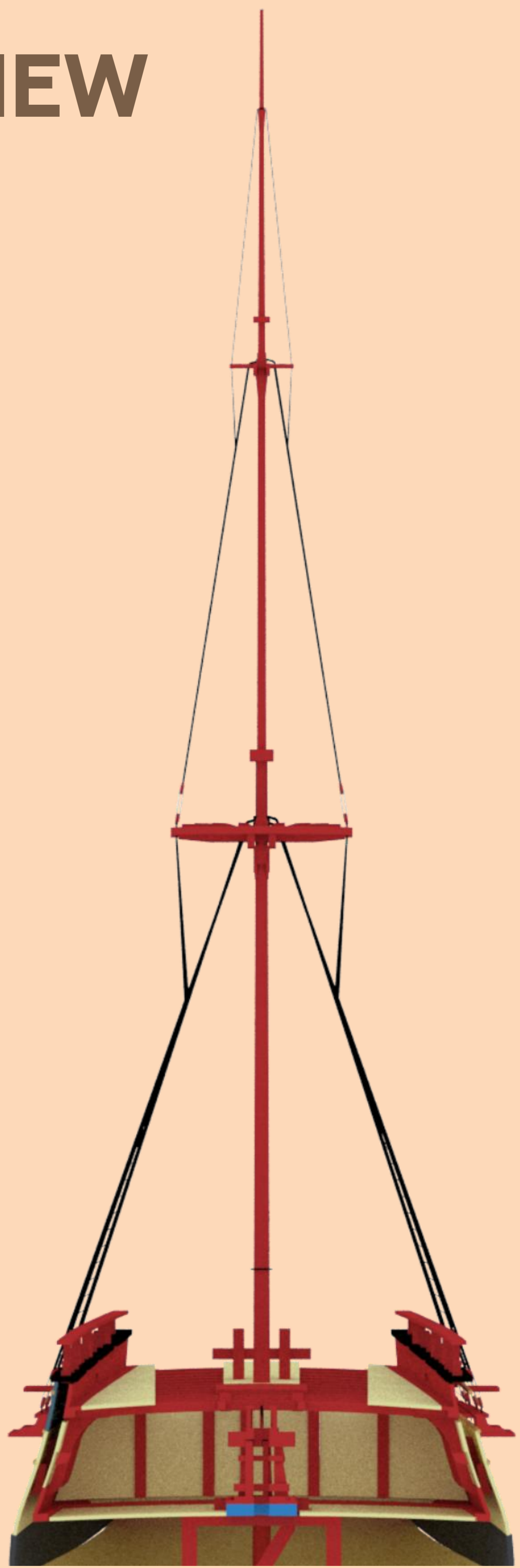
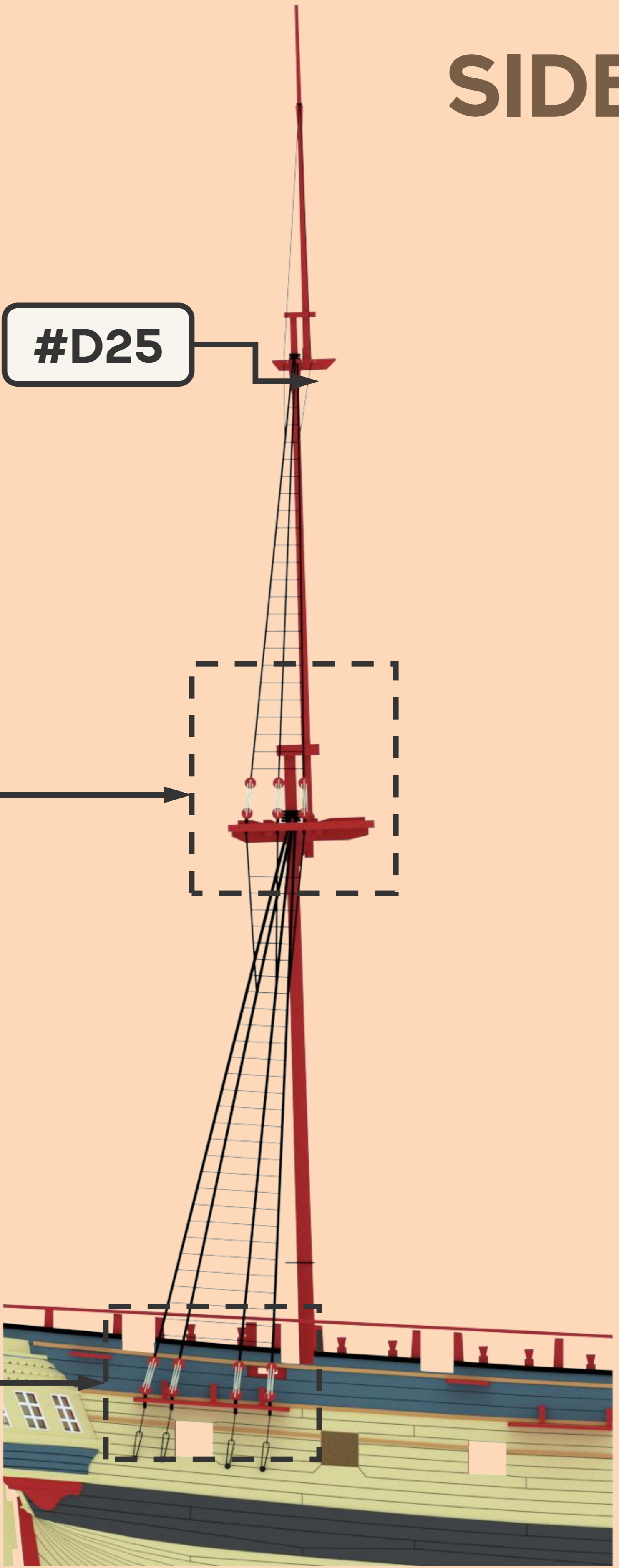



## O3. MIZZEN SHROUDS, TOP MAST SHROUDS & TOP GALLANT SHROUDS

### STEPS:

- 1, Alike Fore and Main mast, first tie the lower shrouds, but only 4 pairs this time. Note that the deadeyes should be smaller ( $\Phi 4\text{mm}$ ), and also using thinner thread.
- 2, The making of the top mast shrouds is also similar to the previous two, apart from the dimension changes, there are only 3 shrouds on each side.
- 3, Make the top-gallant shrouds, please note that there won't be ratlines for these. And unlike the previous two, there are only two of them on each side (instead of three).

# O4. FORE BACKSTAYS

## SIDE, FRONT & TOP VIEW

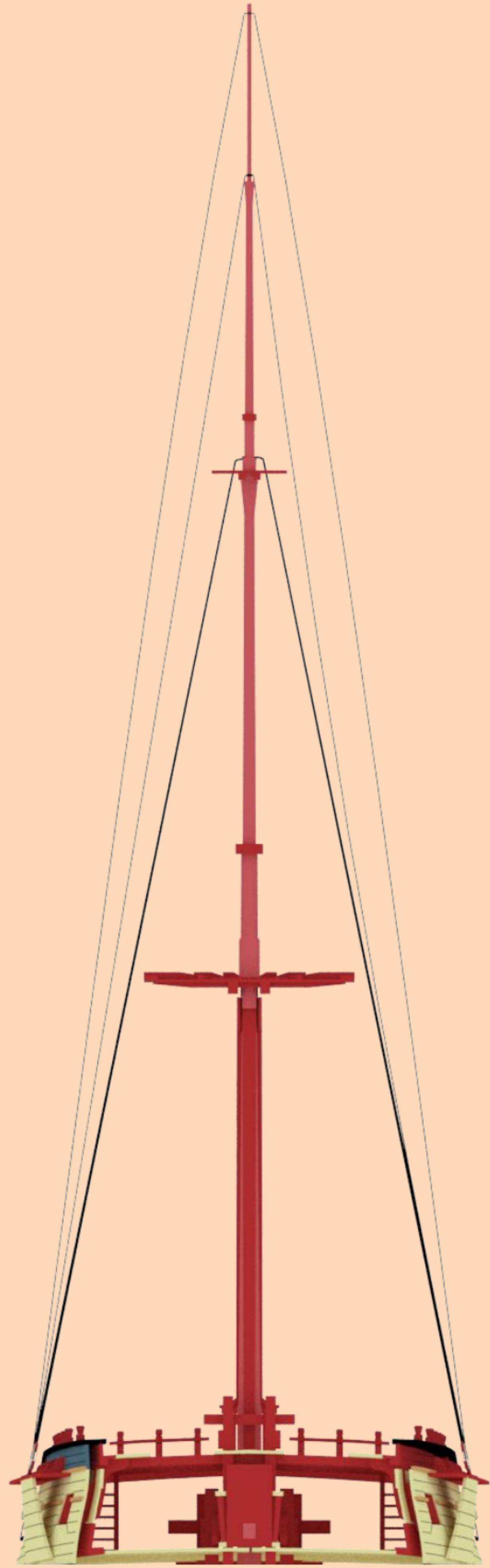
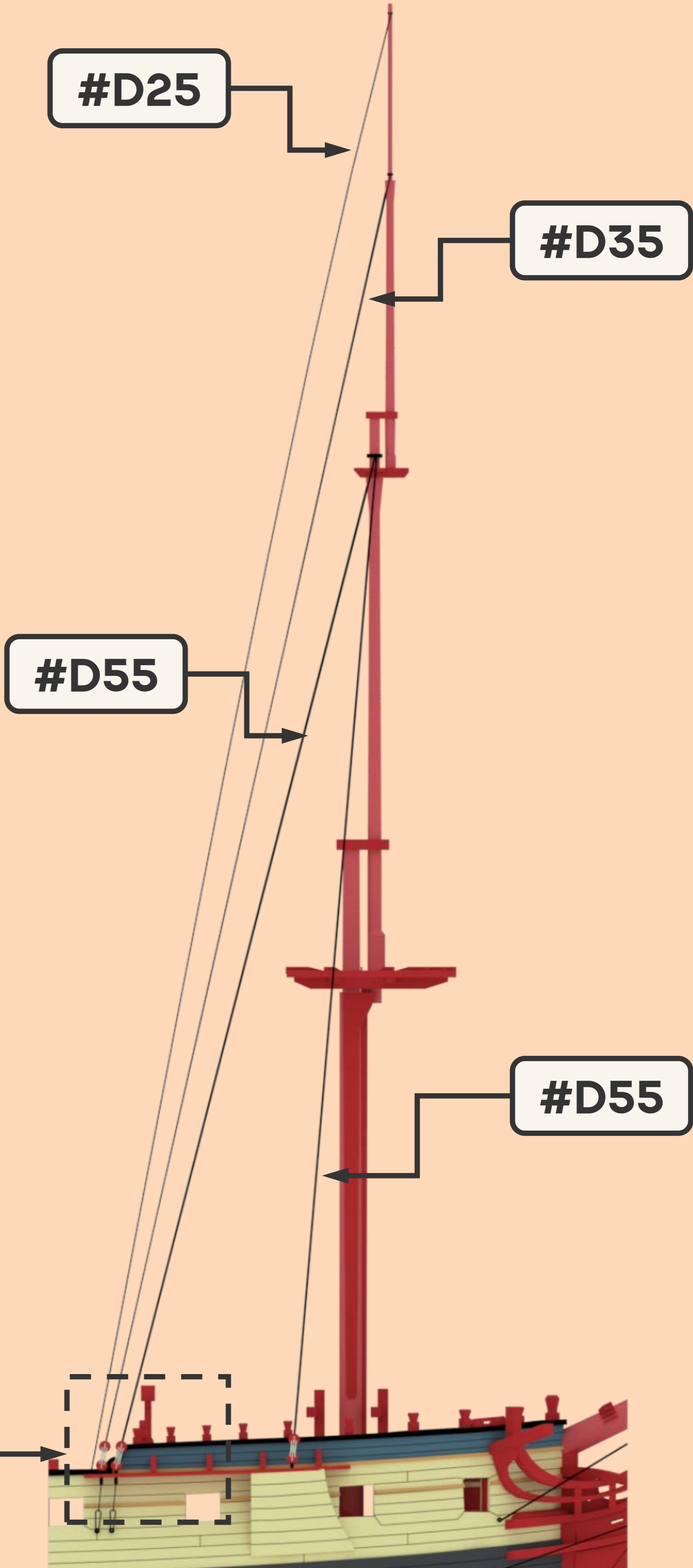
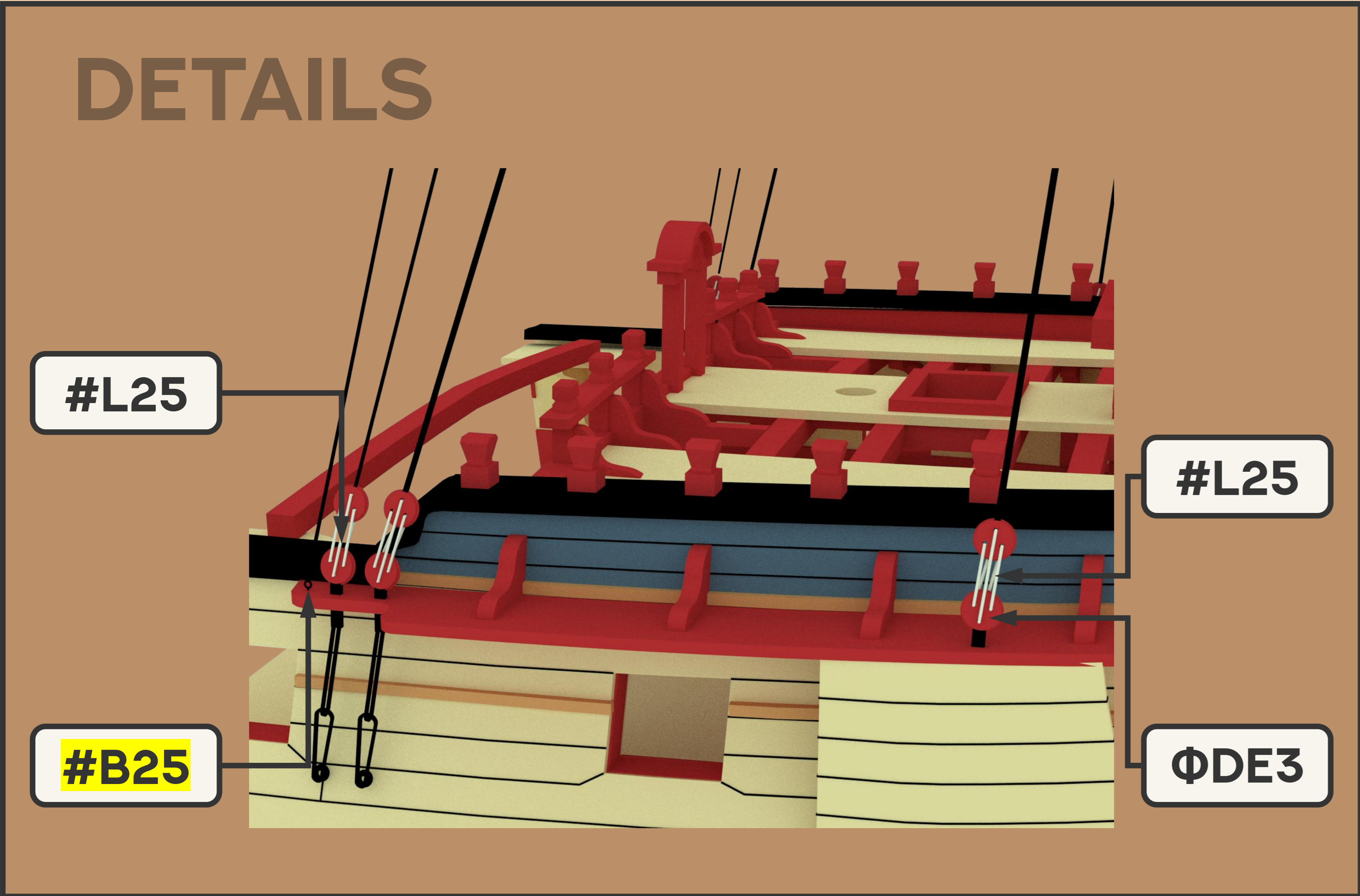
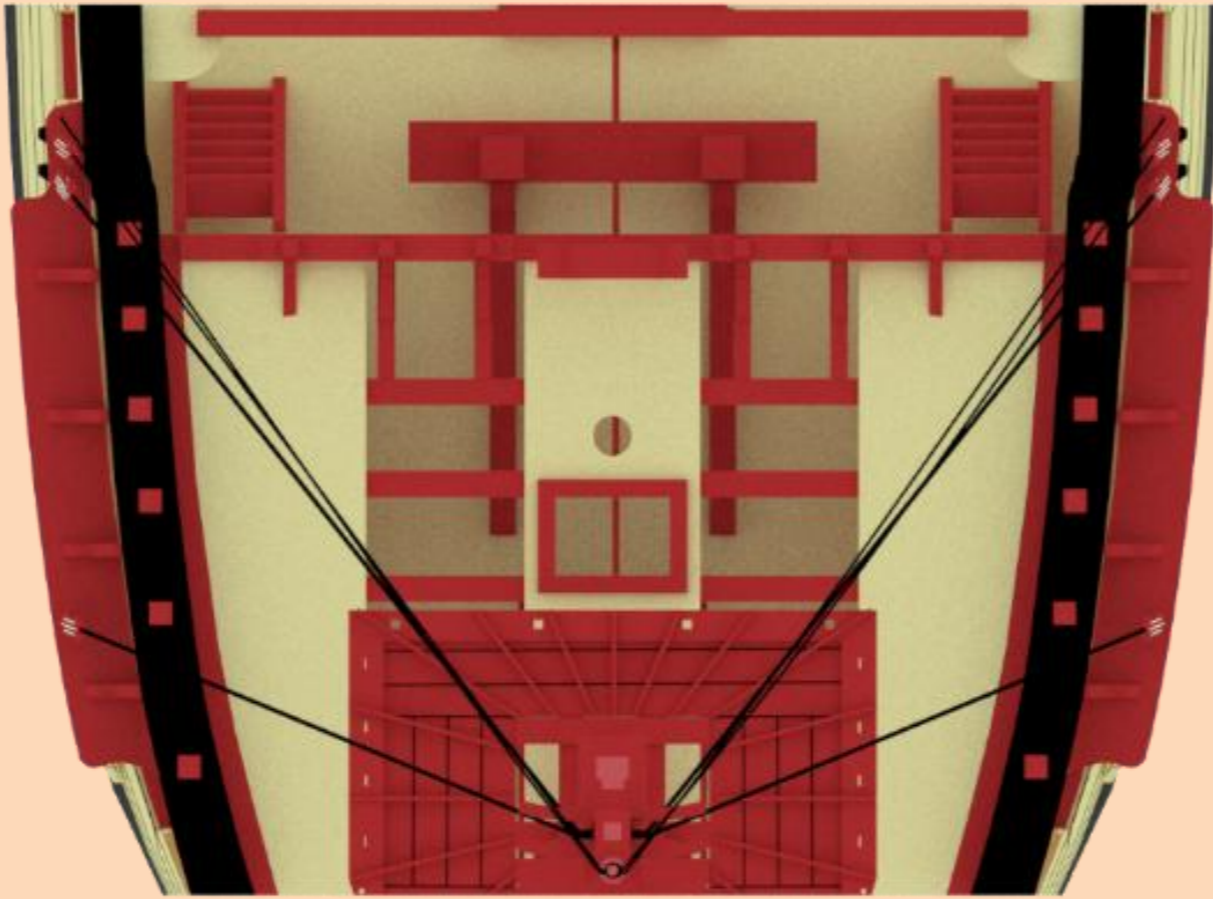

## O4. FORE BACKSTAYS

### STEPS:

- 1, First make the two pairs of topmast standing backstay (the lower two). Let the thread go around the head of topmast head, tie together. Then tie two 3mm deadeye on the end of both two, and connect with the 3mm deadeye on the fore channel.
- 2, Make the a pairs of topgallant mast backstay (the middle one). Also tie a 3mm deadeye at the ends of the thread, and connect with the 3mm deadeye on the fore channel.
- 3, Then make a pair of royal backstay. Tie them on the eye pin on the fore channel.

# O5. FORE SHIFTING BACKSTAY

## SIDE & FRONT VIEW

### DETAILS

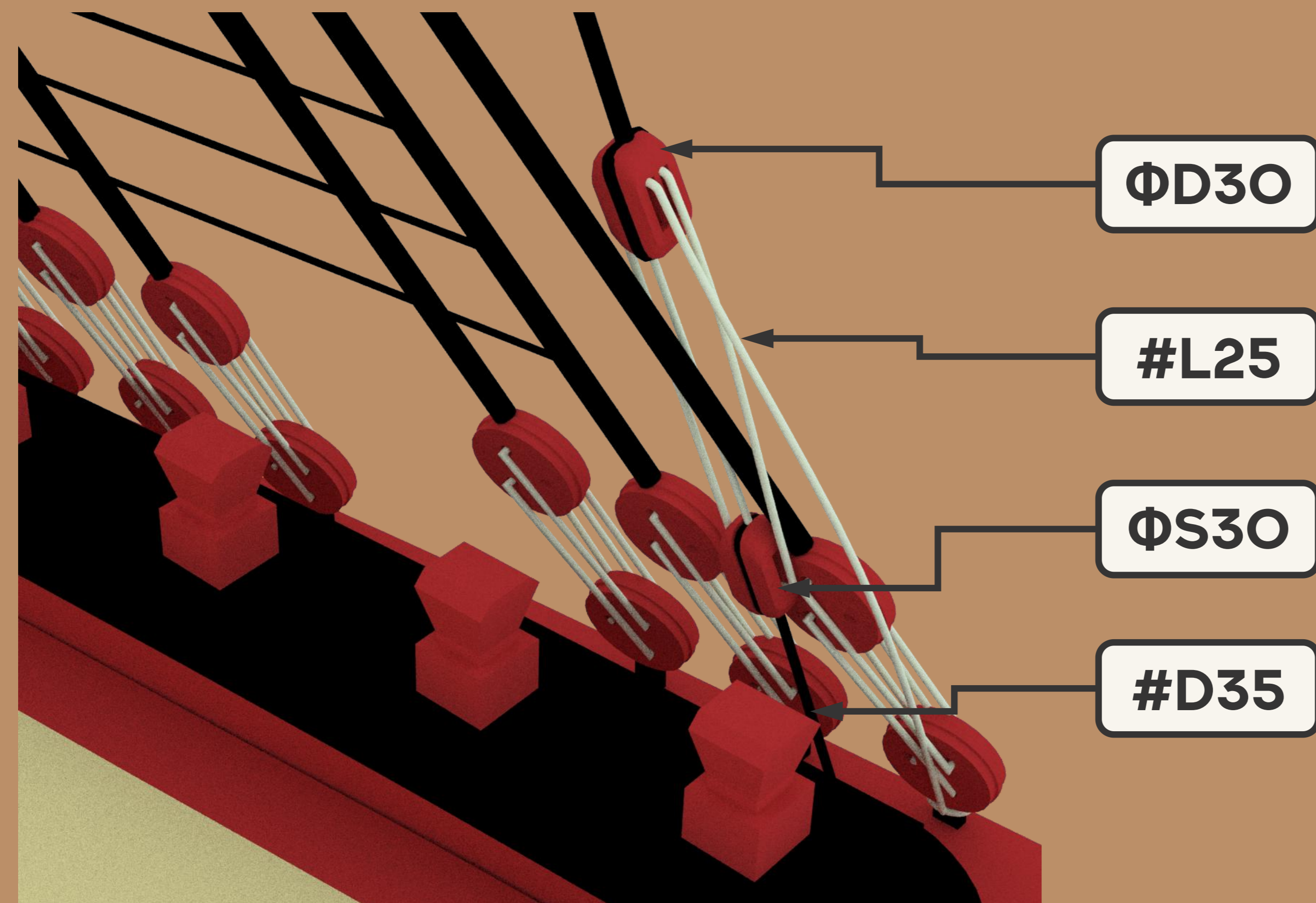

$\#D55$

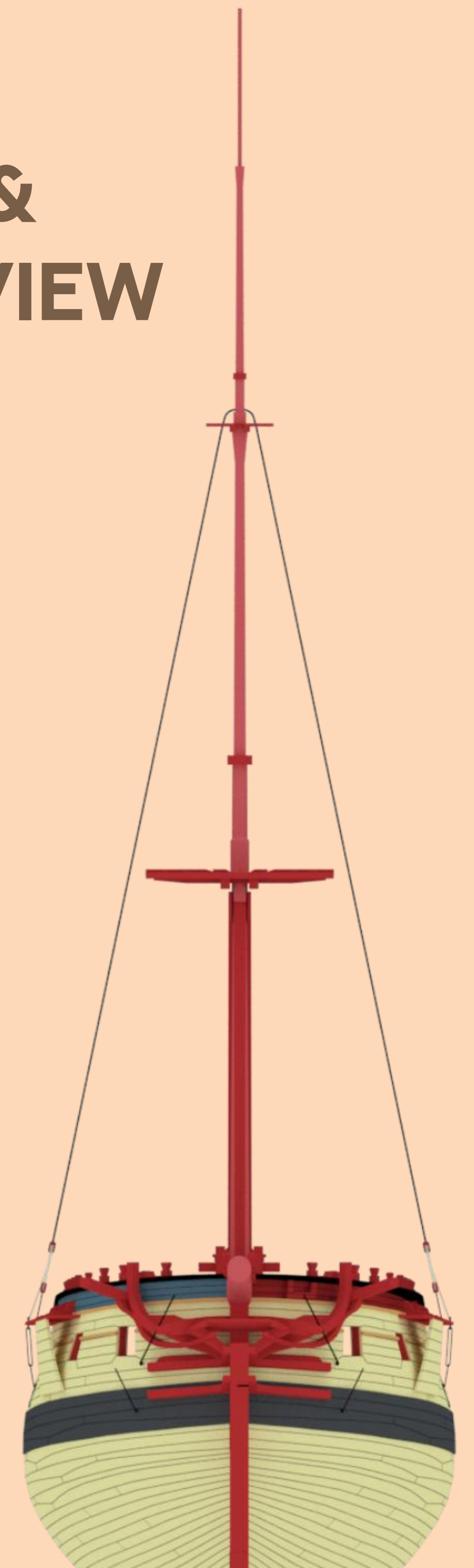
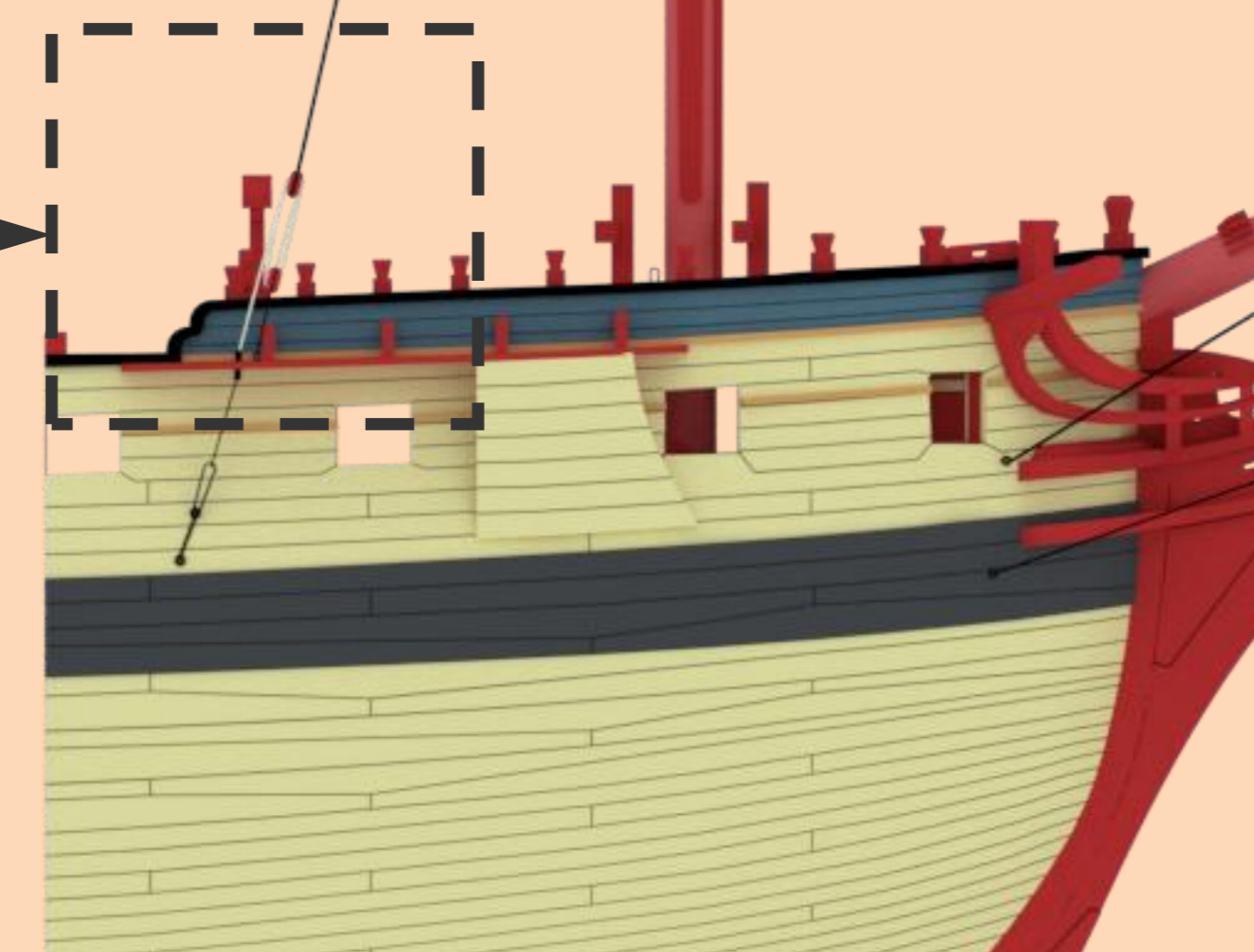

## O5. FORE SHIFTING BACKSTAY

### STEPS:

- 1, Make a pair of shifting backstay. First tie the thread at the head of topmast, then tie a 3mm double block on each side.
- 2, Tie a single block on the eye pin on the fore channel using 0.35mm thread, and then connect this block with the double block on the shifting backstay, finally tie the end of the tackle thread onto the bottom of the last (from bow to stern) 5mm deadeye.

# O6. MAIN BACKSTAYS

## SIDE, FRONT & TOP VIEW

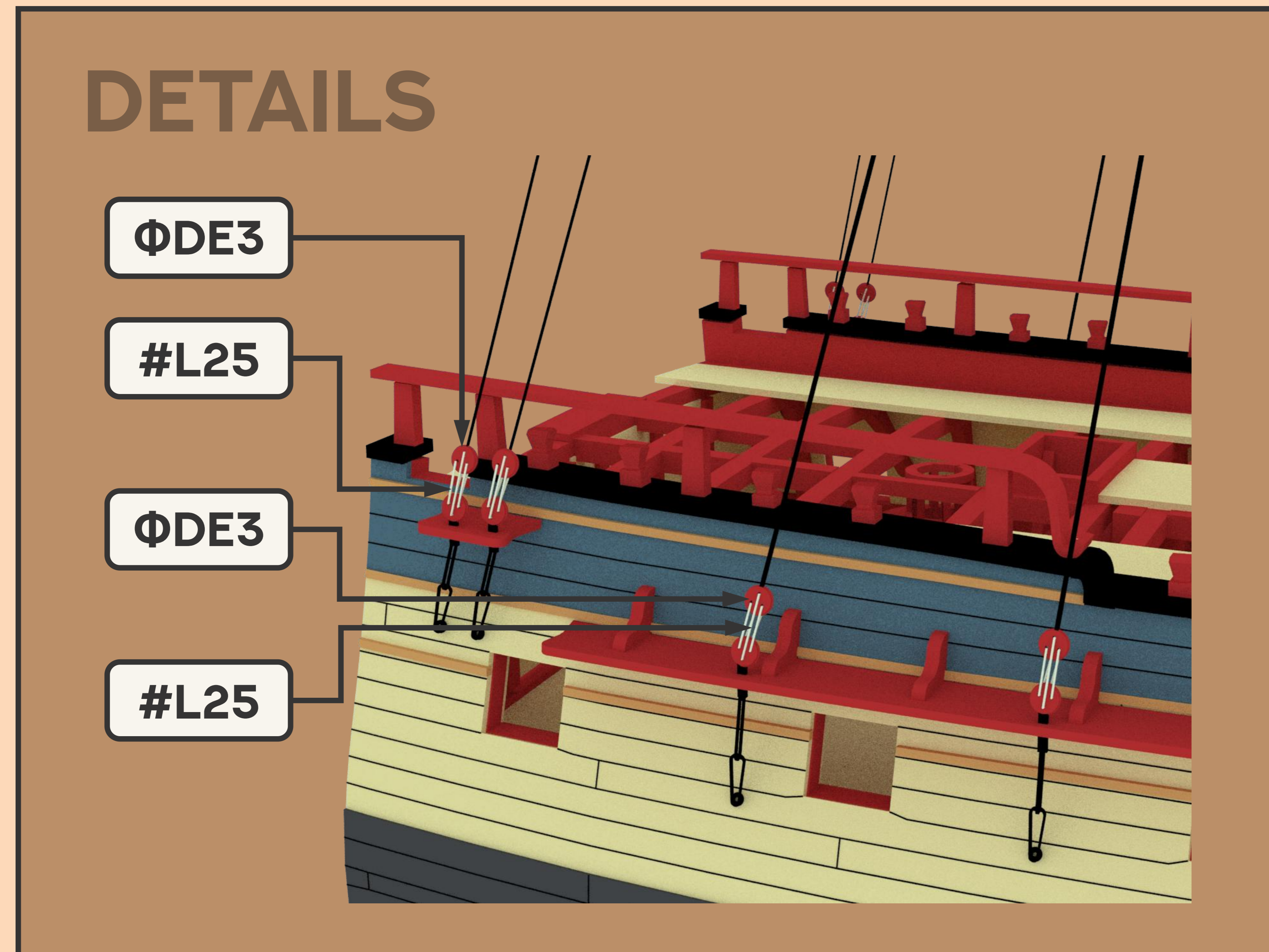
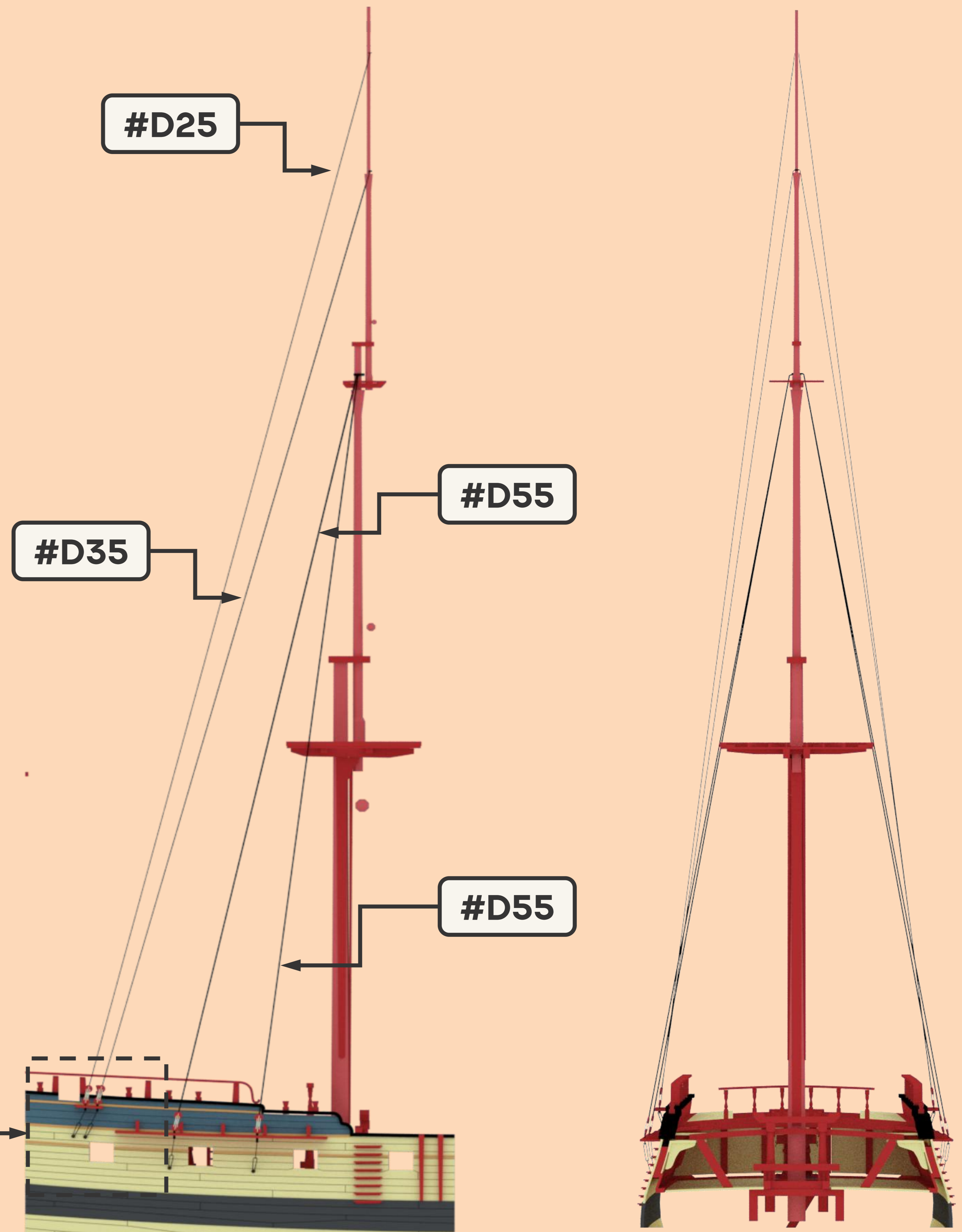
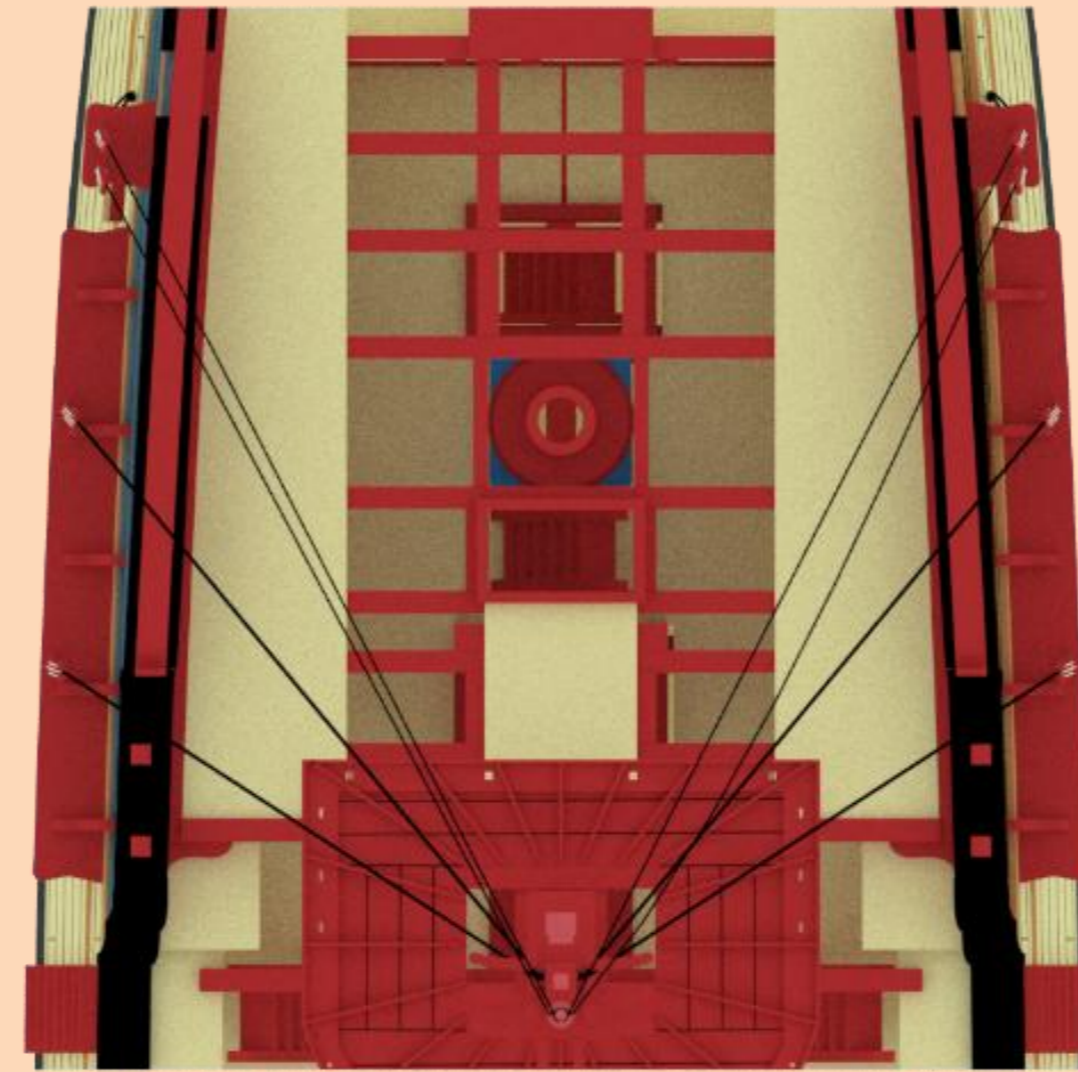

# O7. MAIN SHIFTING BACKSTAY

## STEPS:

The steps are very similar between the main and fore backstay & shifting backstay. But please note that there are 4 deadeyes on each side (for backstays). Also the tackle thread of the shifting backstay ends on the bottom of the second last deadeye (instead of the last).

## DETAILS

ΦD30

#L25

ΦS30

#D35

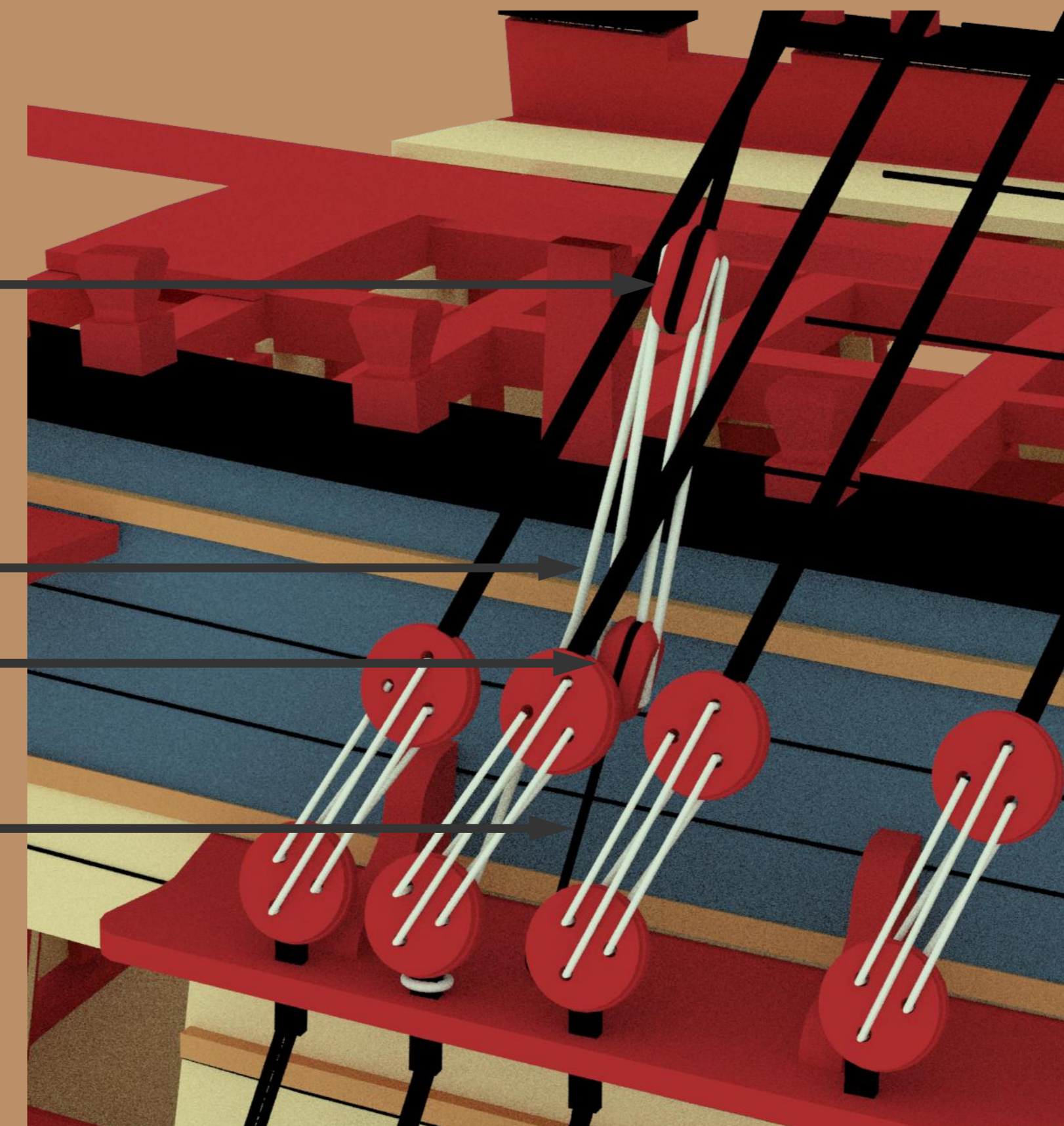

## SIDE VIEW

#D55

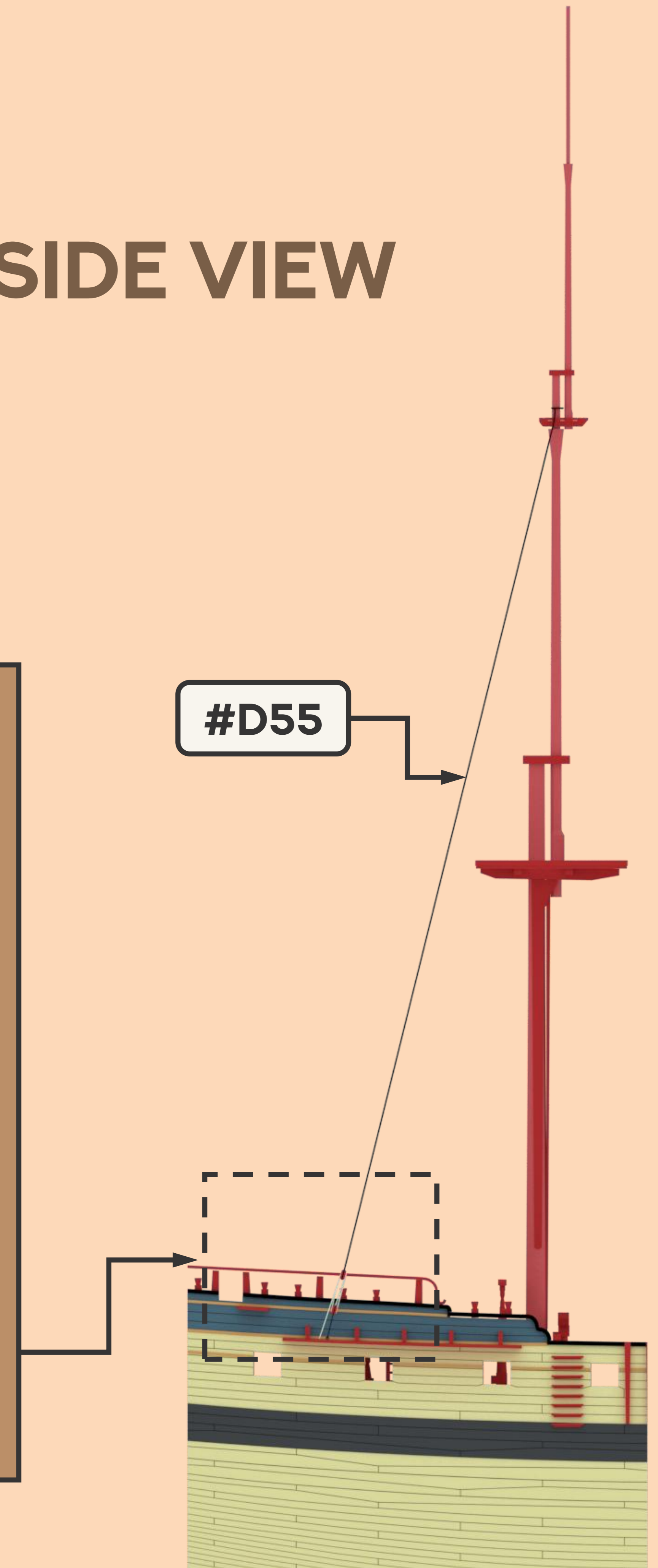

# O8. MIZZEN BACKSTAYS & SHIFTING BACKSTAY

SIDE, FRONT  
& TOP VIEW

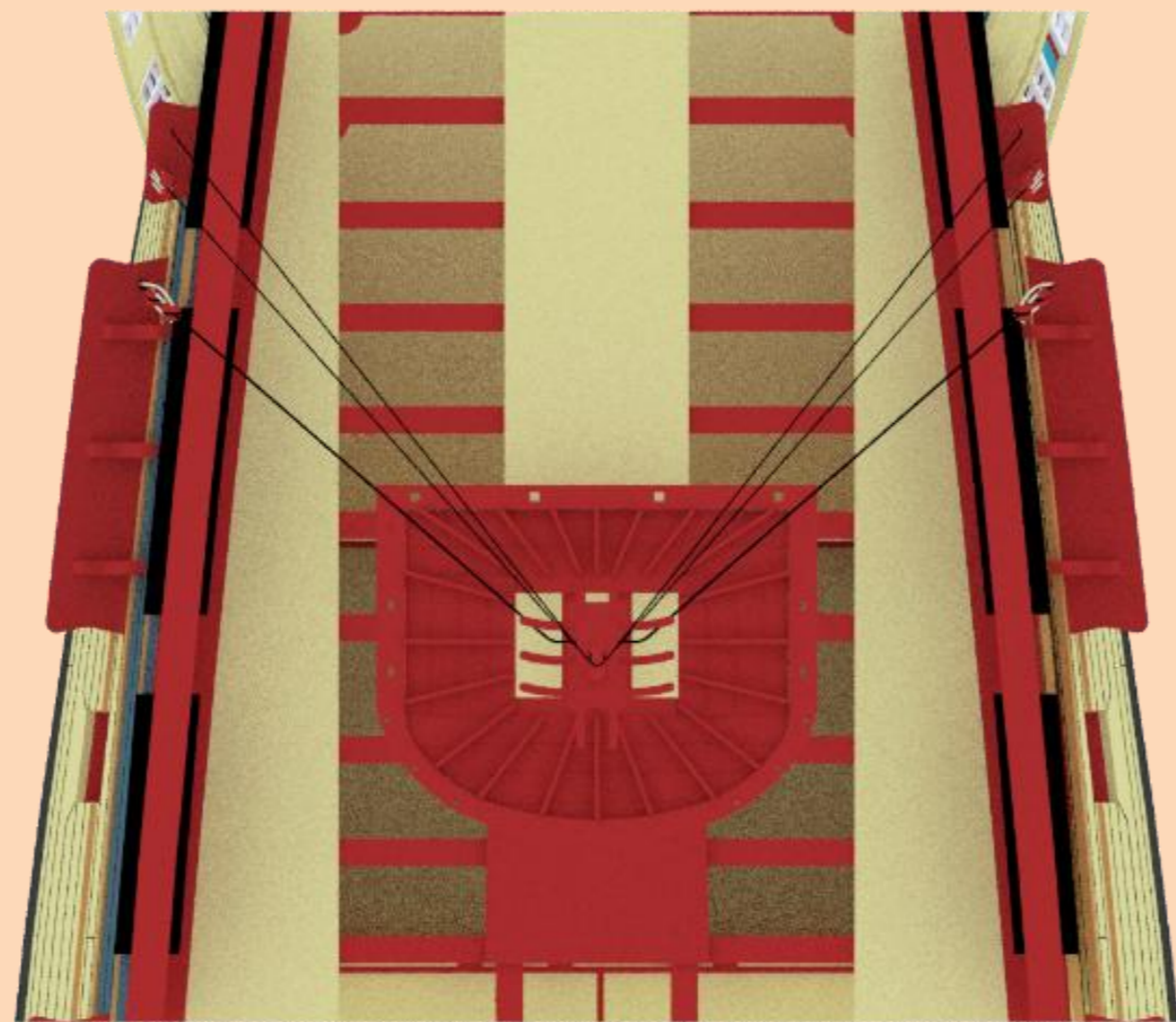

### DETAILS

- #D25
- $\Phi$ DE3
- #L25
- #L25
- $\Phi$ S30
- #D35

A detailed cutaway view of the mizzen mast base and backstay attachment. The mast is a red pole. The backstay is a red rope that passes through a red block and pulley system. The rigging is supported by a complex arrangement of red blocks and pulleys. The mast is mounted on a red base. The backstay is attached to the deck via a red block and pulley system. The rigging is supported by a complex arrangement of red blocks and pulleys.

#D45

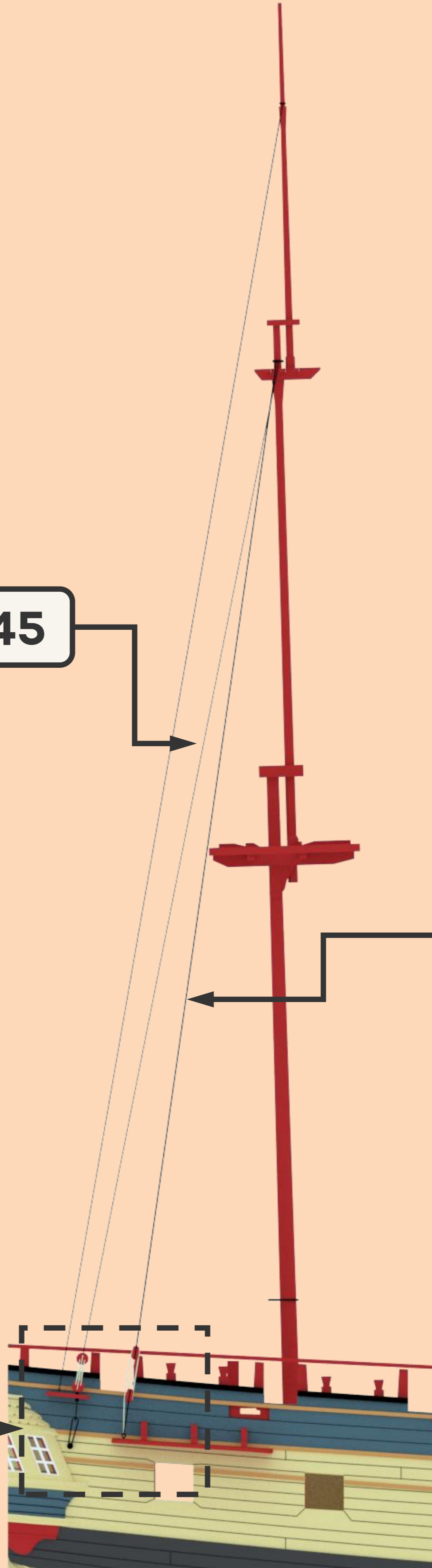

#D45

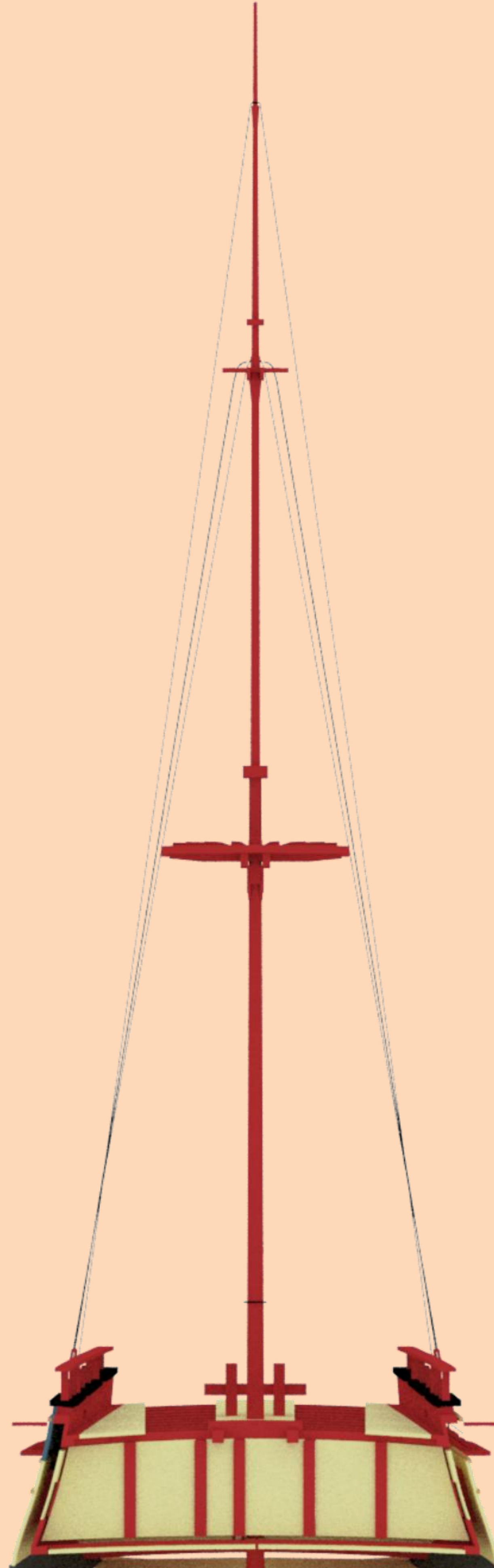



## O8. MIZZEN BACKSTAYS & SHIFTING BACKSTAY

### STEPS:

- 1, First make the mizzen backstay. There's only one pair, with 3mm deadeye at the end. Connect with the 3mm deadeye on the small channel.
- 2, Then make the shifting backstay, using 0.45mm thread with 3mm single blocks.
- 3, Finally make the mizzen topgallant backstays. Also one pair, connect to the eye pin on the small channel directly.

# CONTENTS SO FAR

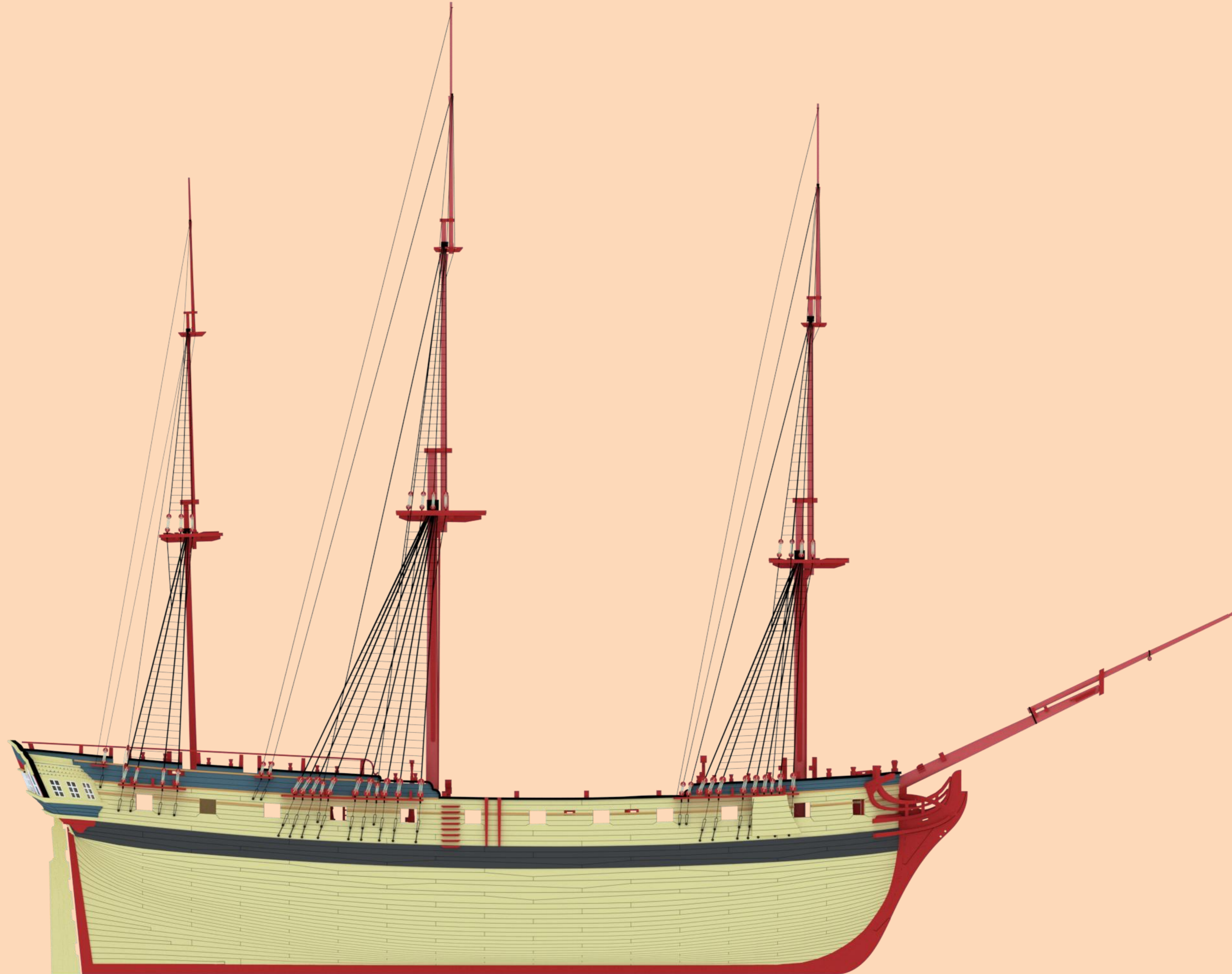

# O9. BOBSTAY & BOWSPRIT SHROUDS

## DETAILS

#D55

#L25

ΦH30

#D80

ΦH40

#L25

## SIDE & TOP VIEW

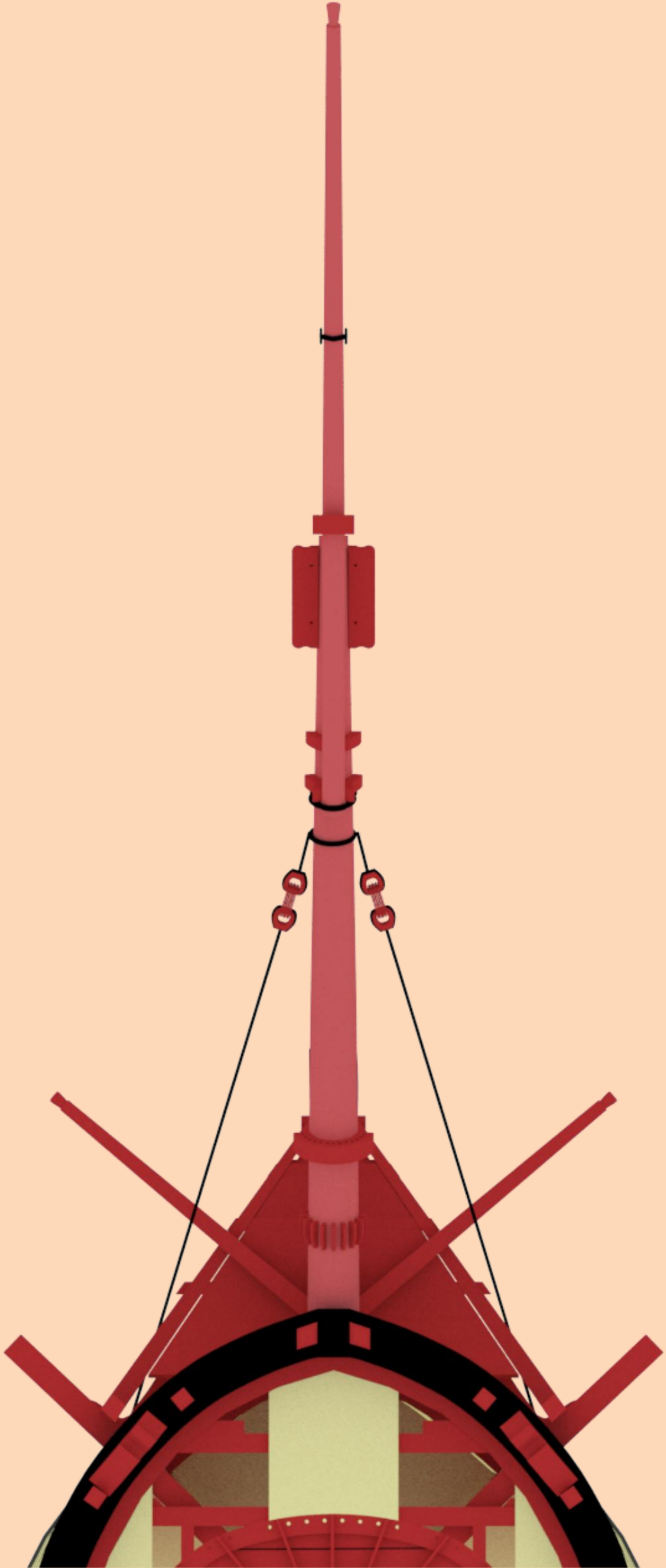
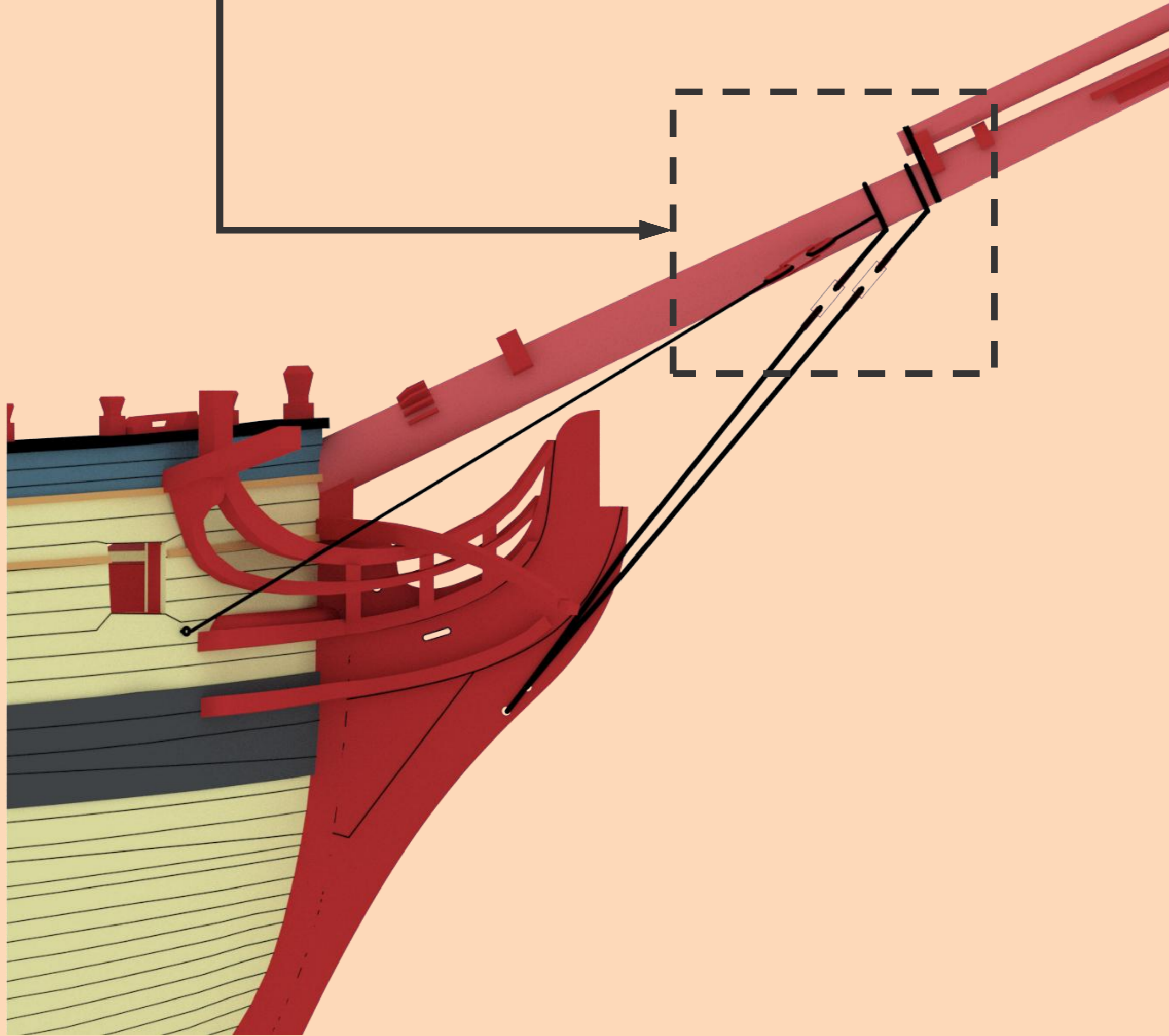

## O9. BOBSTAY & BOWSPRIT SHROUDS

### STEPS:

- 1, Make two pairs of bobstay using 0.8mm thread. Attach two 4mm heart block at the end. Also tie two heart block on the bowsprit, and connect two pairs of heart block using 0.25mm light thread.
- 2, Tie a bowsprit shrouds on each side of the ship's bow (on eye pins). Attach a 3mm heart block on each, and tie two heart blocks on the bowsprit, the position of the two small hearts should be behind of the second bobstay. Then also connect these hearts using 0.25mm light thread.

# 10. BUMKIN SHROUDS

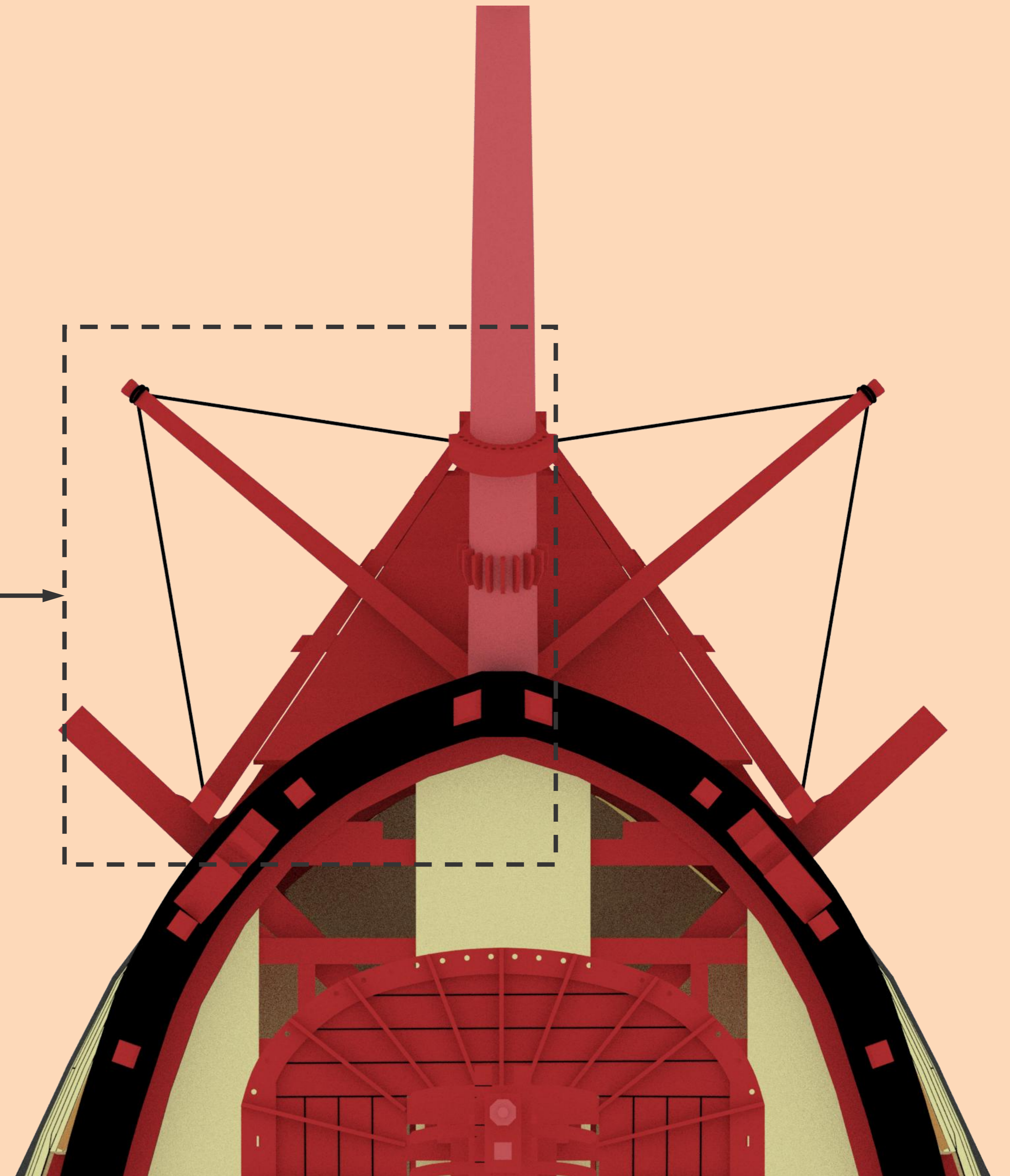
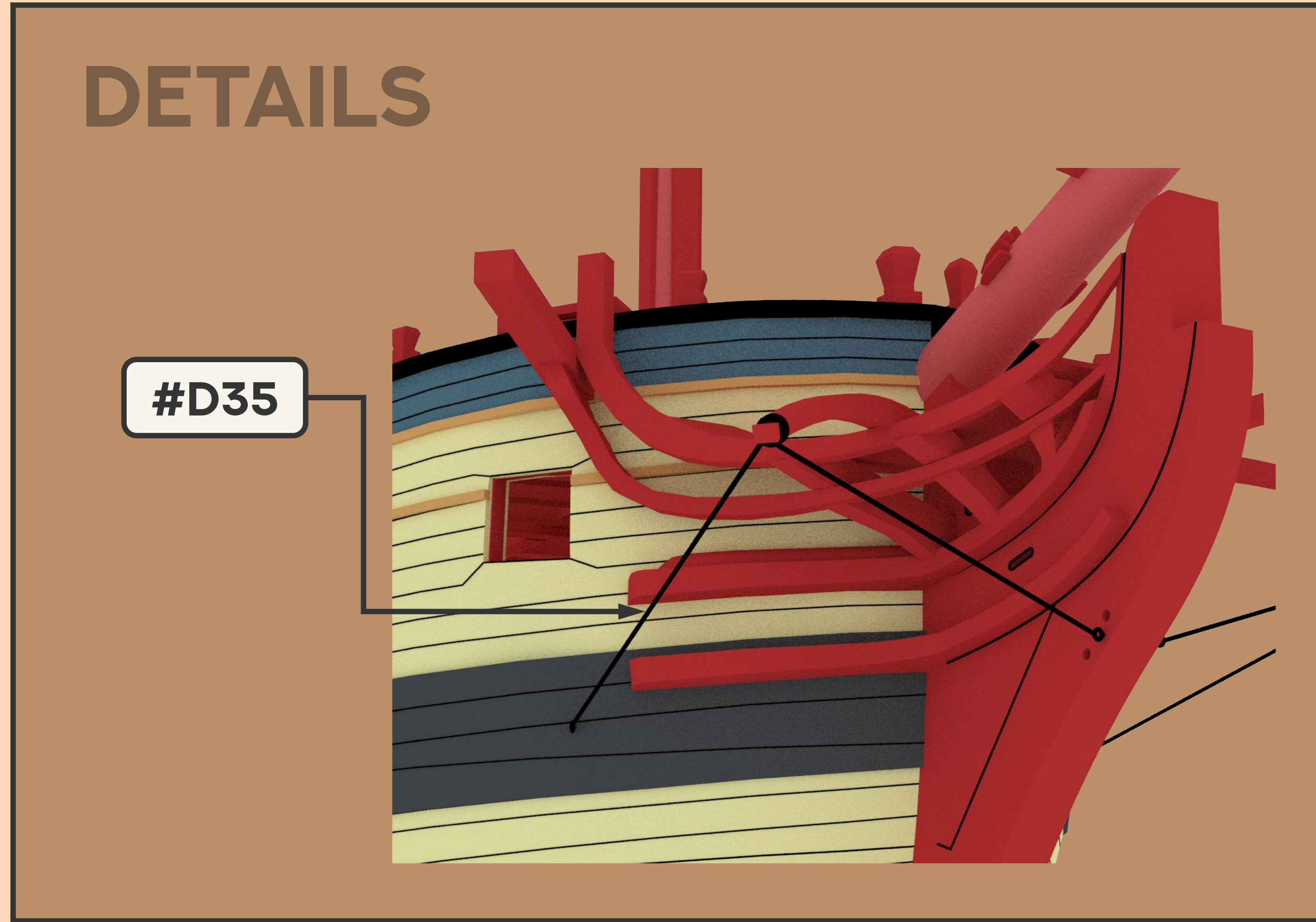

# 11. FORESTAY & FORE PREVENTER STAY

## DETAILS

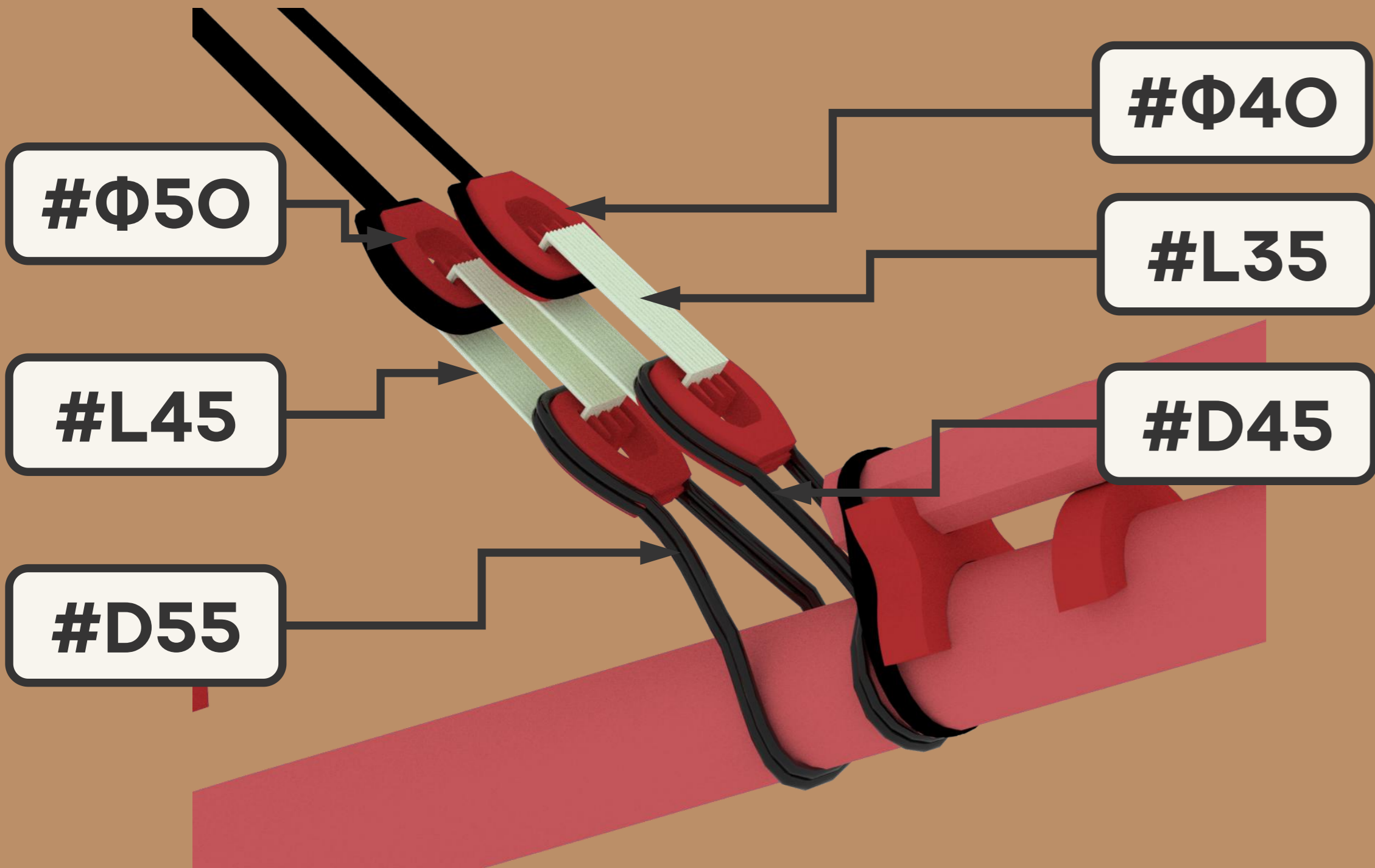
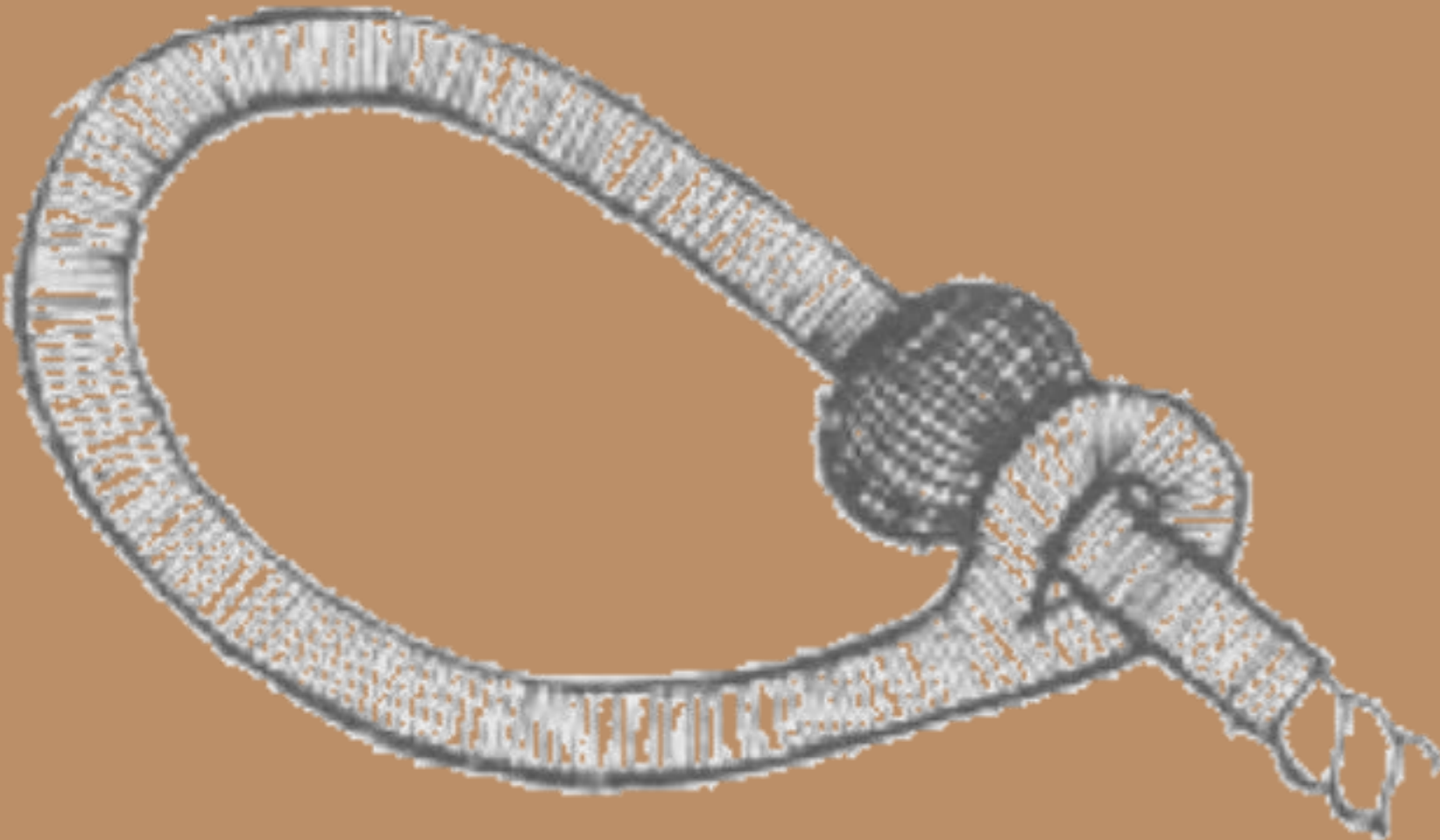

## SIDE & FRONT VIEW

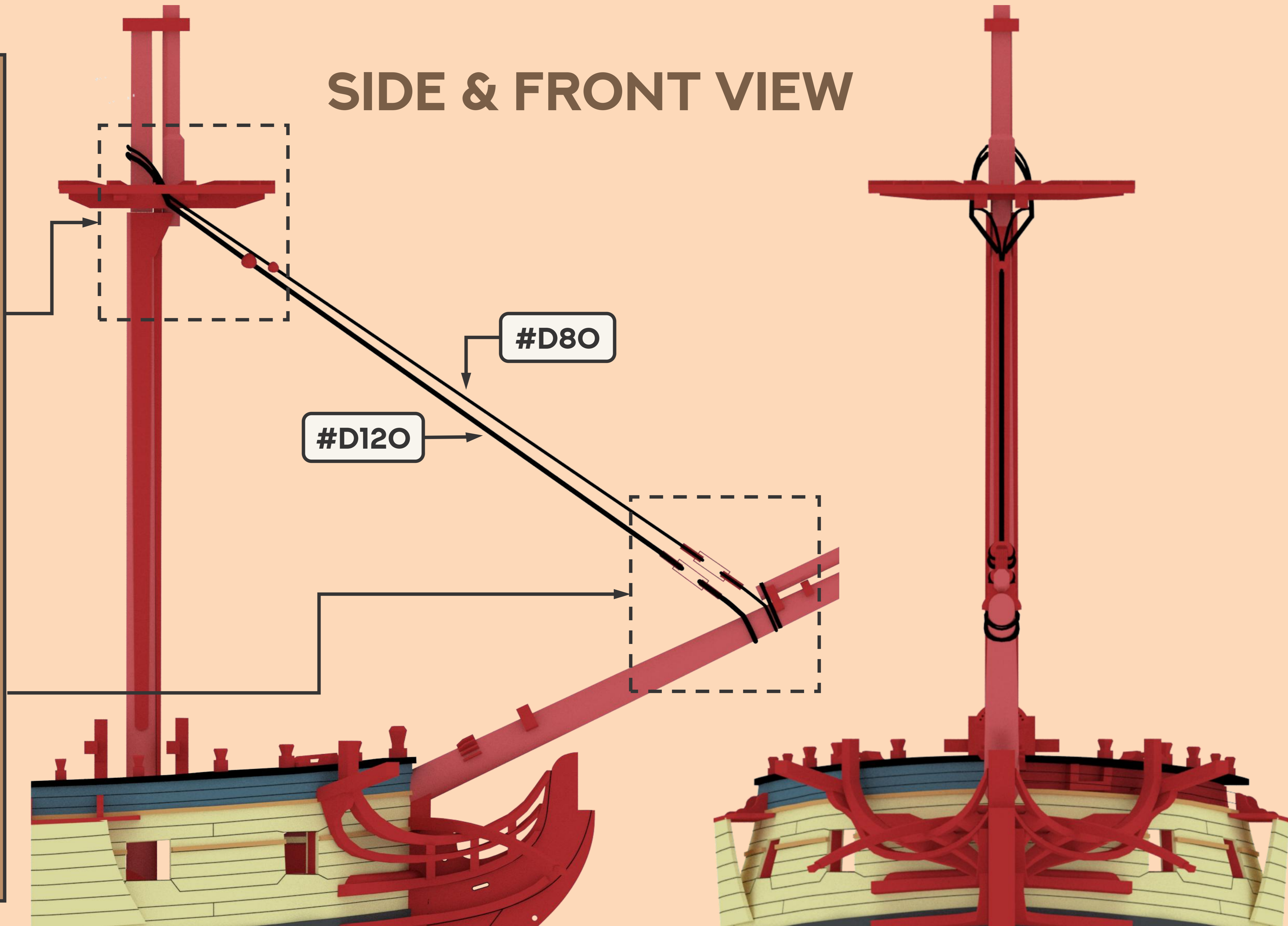

# 11. FORESTAY & FORE PREVENTER STAY

## STEPS:

- 1, First tie the collars for the forestay and fore preventer stay. The collars are all doubled. Secure a 4mm and a 5mm heart block onto the collars at the bowsprit, the 4mm block should be at the front and the 5mm should be at the back.
- 2, Then make the forestay. Get the forestay go around the fore mast head and secure it. Attach a 5mm heart block at the end of the main stay, and connect it with the 5mm heart block at the bowsprit.
- 3, Repeat the process in a similar way for the preventer stay, but be careful with the diameters of the threads.

# 12. FORE TOPMAST STAY, FORE TOPMAST PREVENTER STAY, FORE TOPGALLANT STAY & FORE ROYAL STAY

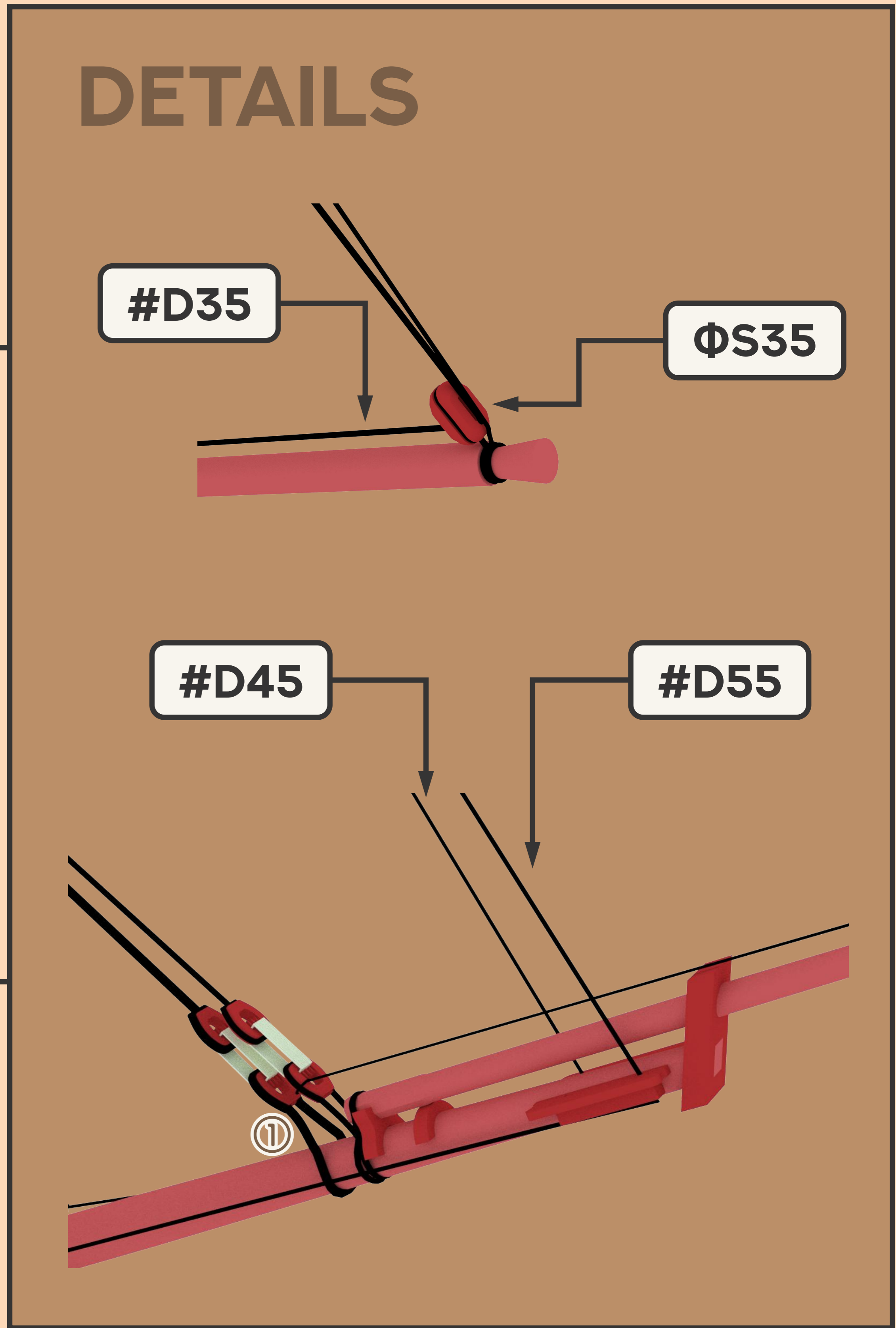
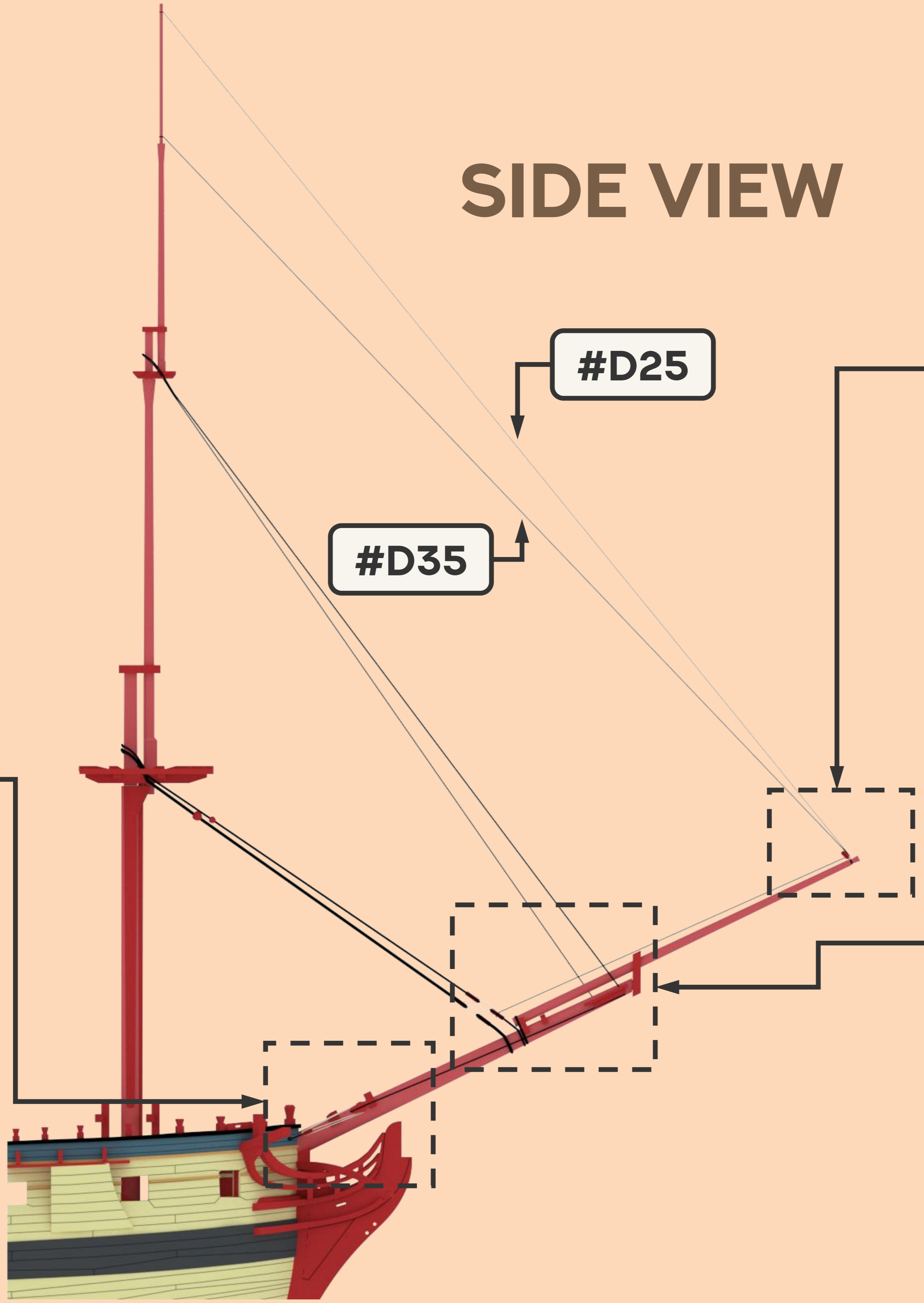
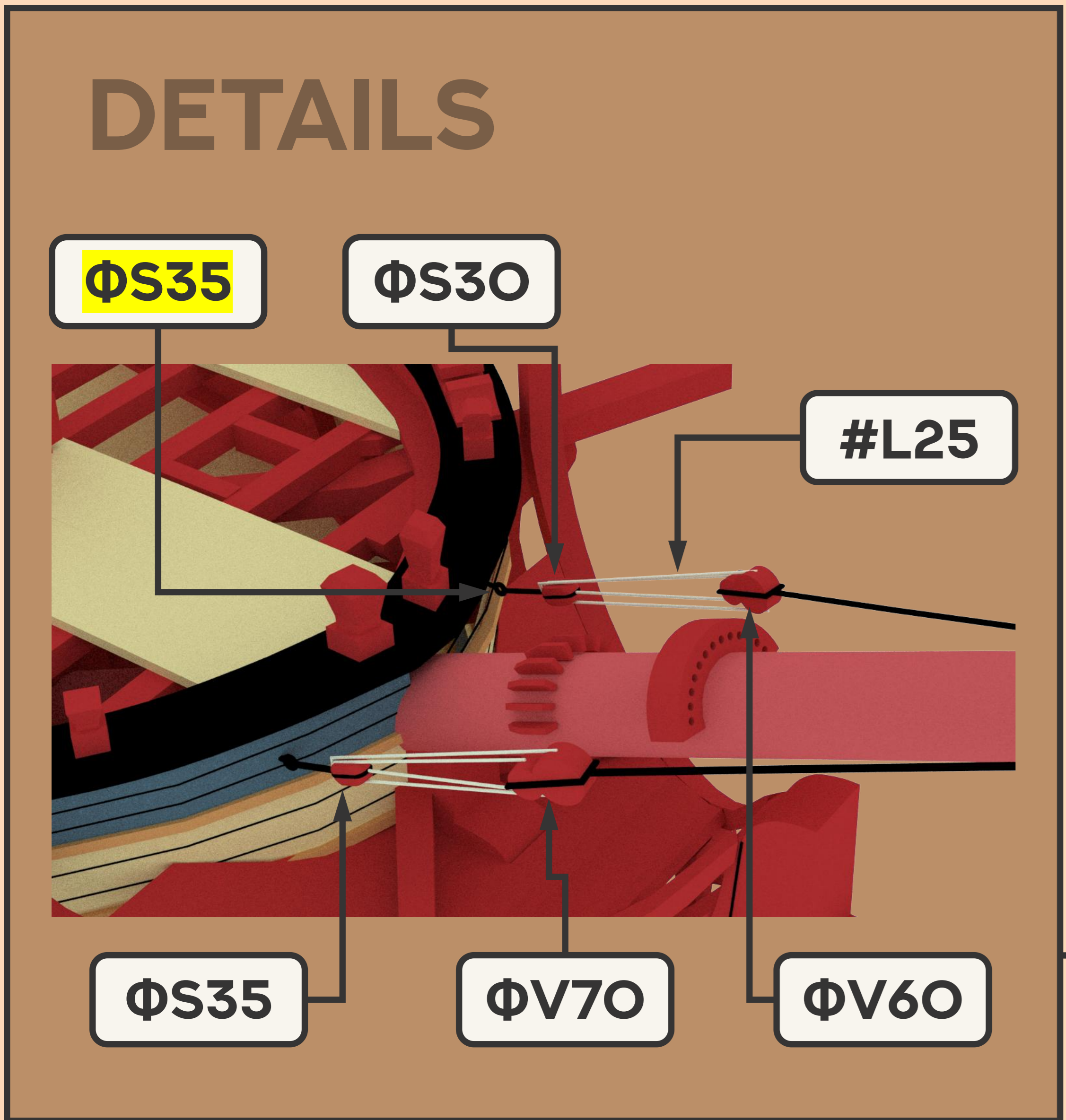



## 12. FORE TOPMAST STAY, FORE TOPMAST PREVENTER STAY, FORE TOPGALLANT STAY & FORE ROYAL STAY

### STEPS:

1, First make the fore topmast stay and fore topmast preventer stay. Tie one side on the topmast trees, let the other side go through the bee on the bowsprit. The fore topmast stay should go through the front hole of the bee on the right (starboard side). The fore topmast preventer stay should go through the back hole of the bee on the left (port side).

2, After going through the hole, tie a 7mm violin (long tackle) block at the end of fore topmast stay, and tie a 6mm violin block at the end of fore topmast preventer stay. Attach two eye pin on the bow, tie a 3.5mm single block using 0.35mm thread on the starboard pin, and tie a 3.0mm single block on the port pin. Use 0.25mm white thread to tie the tackle in between the blocks as illustrated.

## 12. FORE TOPMAST STAY, FORE TOPMAST PREVENTER STAY, FORE TOPGALLANT STAY & FORE ROYAL STAY

### STEPS:

3, Tie a 3.5mm single block at the front end of the Jib-boom. Tie one end of the head of fore topgallant stay at the illustrated position, get the other end through the single block that just tied. Then get it going backwards, and tie on the heart block of the preventer stay (as shown on mark ①)

4, Tie the fore royal stay as illustrated.

# 13. MAIN STAY & MAIN PREVENTER STAY

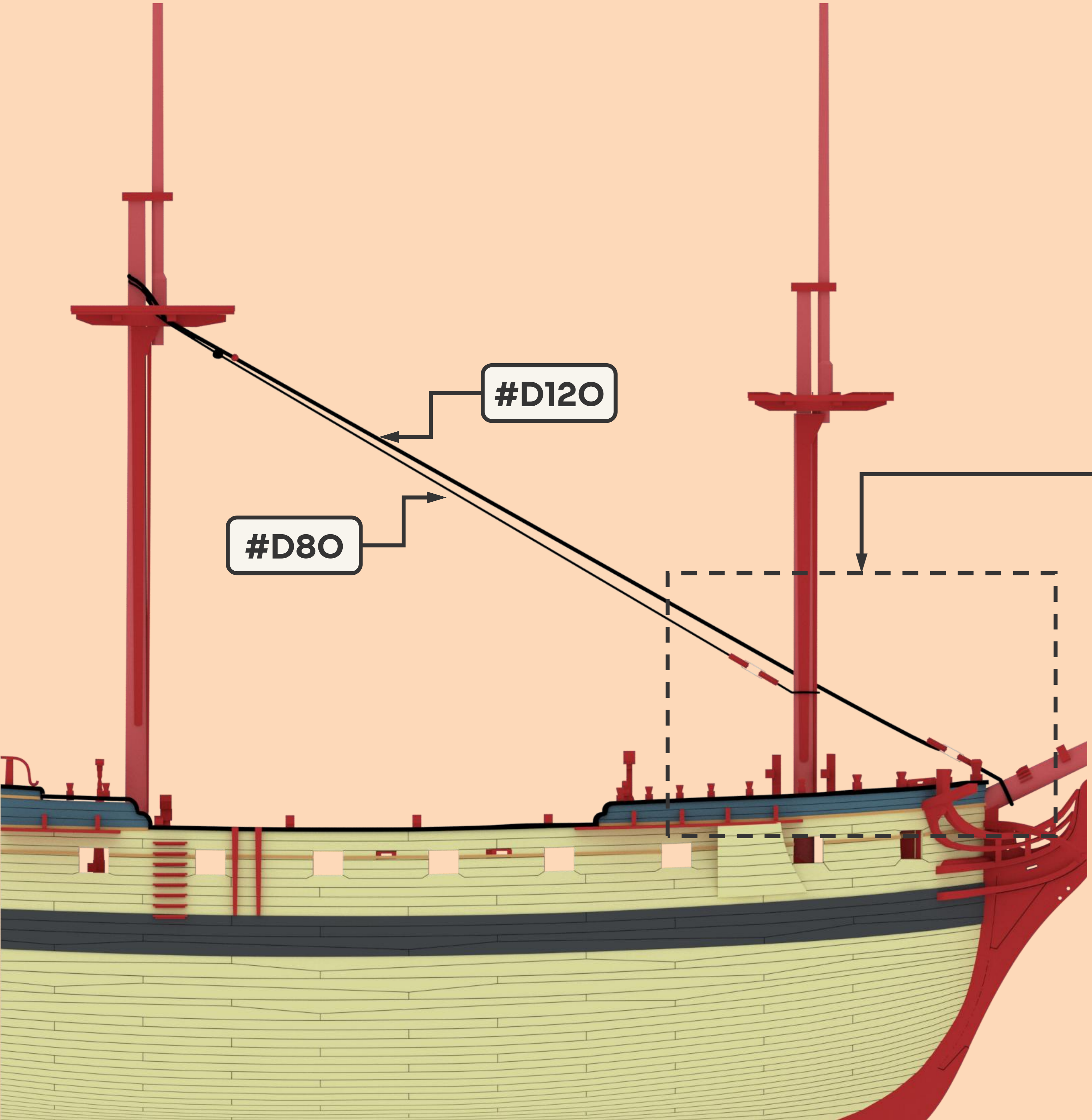

#D120

#D80

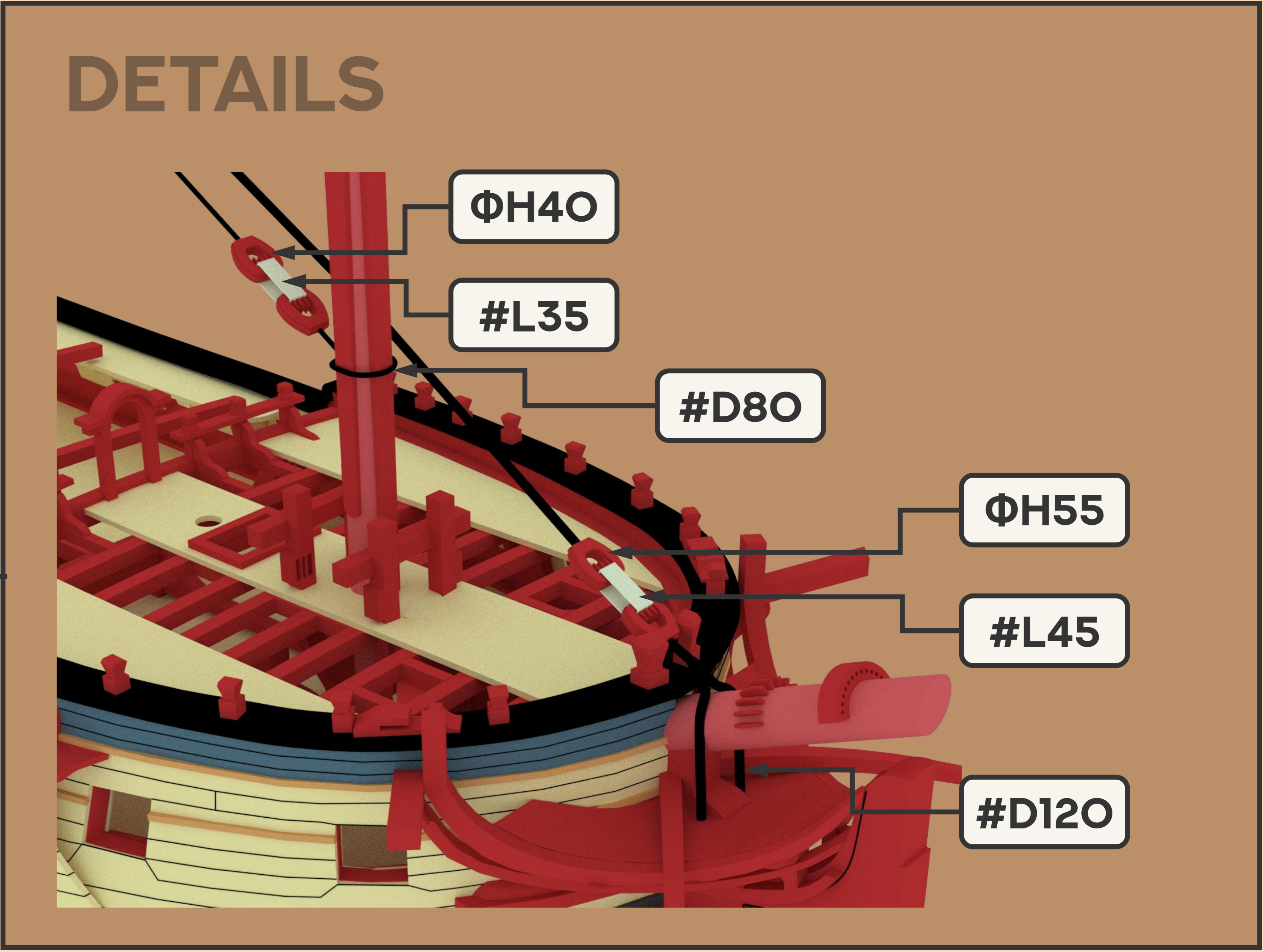

ΦH40

#L35

#D80

ΦH55

#L45

#D120

## 13. MAIN STAY & MAIN PREVENTER STAY

### STEPS:

- 1, First tie the collar for the main stay. Get the 1.2mm thread through the hole on the gammoning knee, then make the entire thread become a ring. Tie a 5.5mm heart block onto the back end of the ring. Also tie a 4mm heart block at the near bottom of the foremast.
- 2, Then make the main stay. Get the main stay go around the main mast head and secure it. Attach a 5.5mm heart block at the end of the main stay, and connect it with the 5.5mm heart block at the bow.
- 3, Repeat the process in a similar way for the preventer stay, but be careful with the diameters of the threads.

# 14. MAIN TOPMAST STAY & MAIN TOPMAST PREVENTER STAY

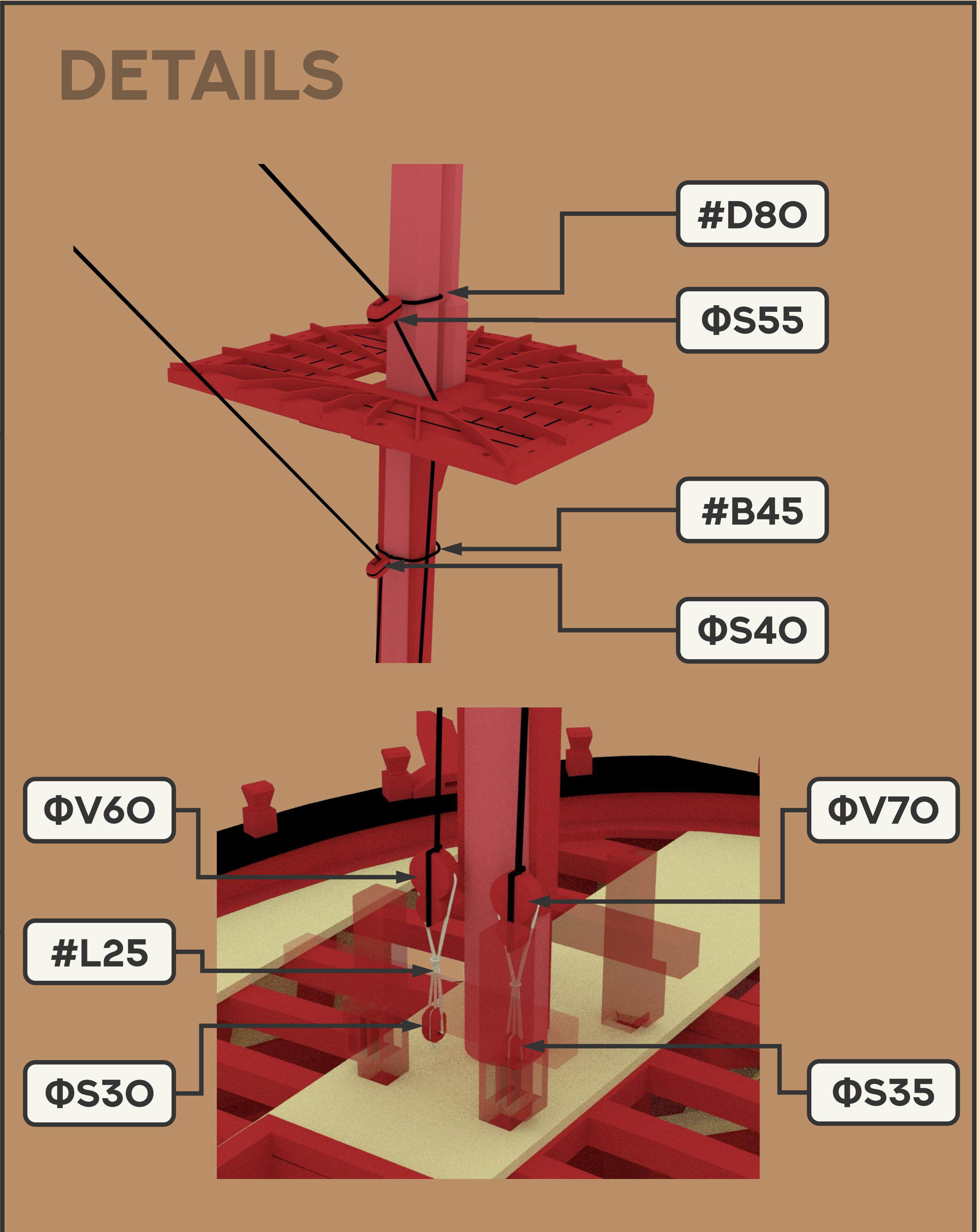
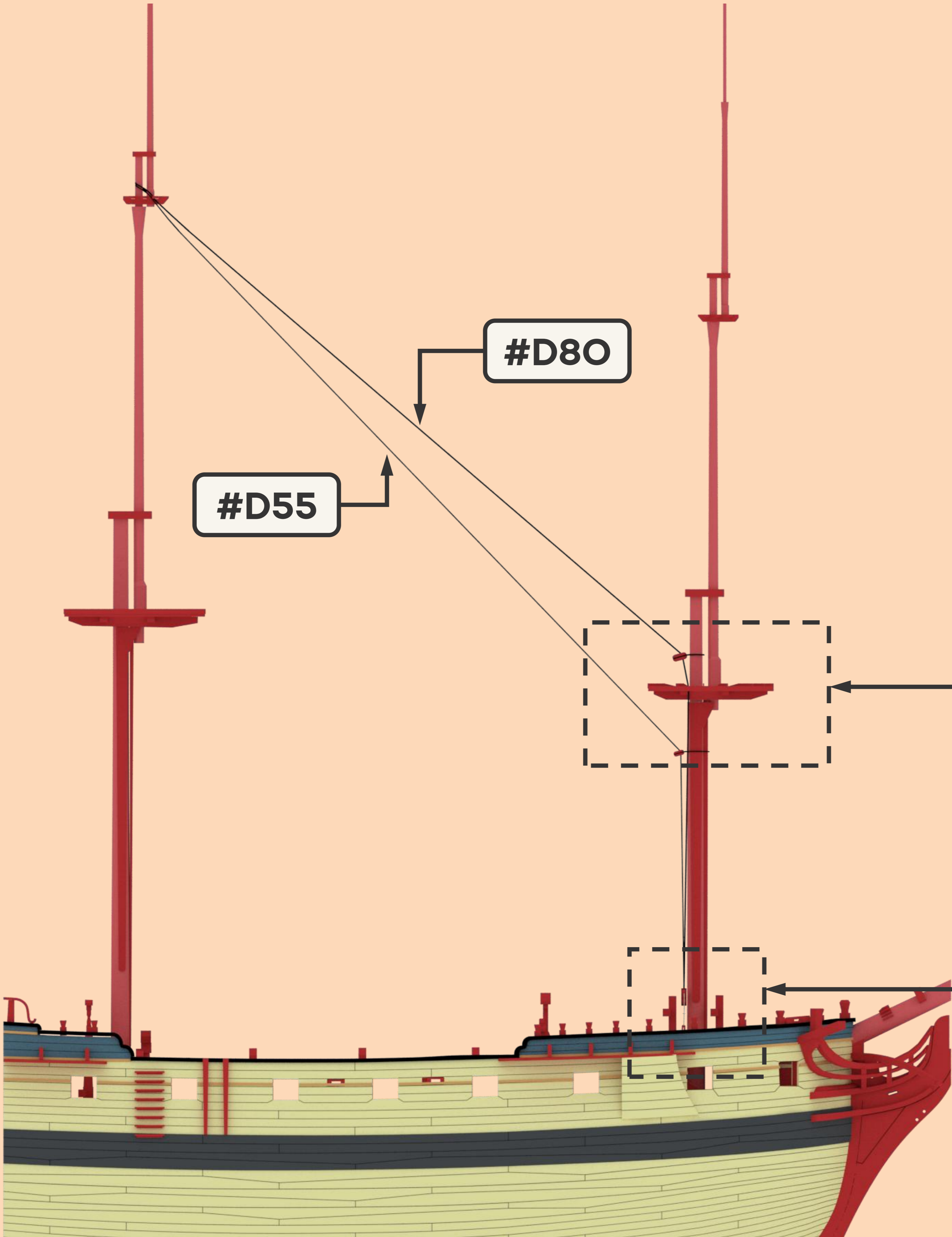

## 14. MAIN TOPMAST STAY & MAIN TOPMAST PREVENTER STAY

### STEPS:

1, First make the main topmast stay. Tie a 5.5mm single block on the foremast head. Get the main topmast stay go around the main topmast head and secure it, and get it through the single block. Finally tie a 7mm violin block at the end of the thread.

2, Then make the top preventer stay in a similar way, but the single block for this stay is tied on the mast cheeks. Also get the preventer stay through the smaller single block, and finally tie a 6mm violin block at the end of the thread.

3, Tie two single blocks on the eye pins on the deck behind the fore mast, a 3mm block on the left and a 3.5mm block on the right. Connect the 3.5mm single block with the 7mm violin block from topmast stay, and the 3.0mm single block with the 6mm violin block from the preventer stay. Finally tie both tackles back to themselves (go around the tackle and tie).

# 15. MAIN TOPGALLANT STAY & MAIN ROYAL STAY

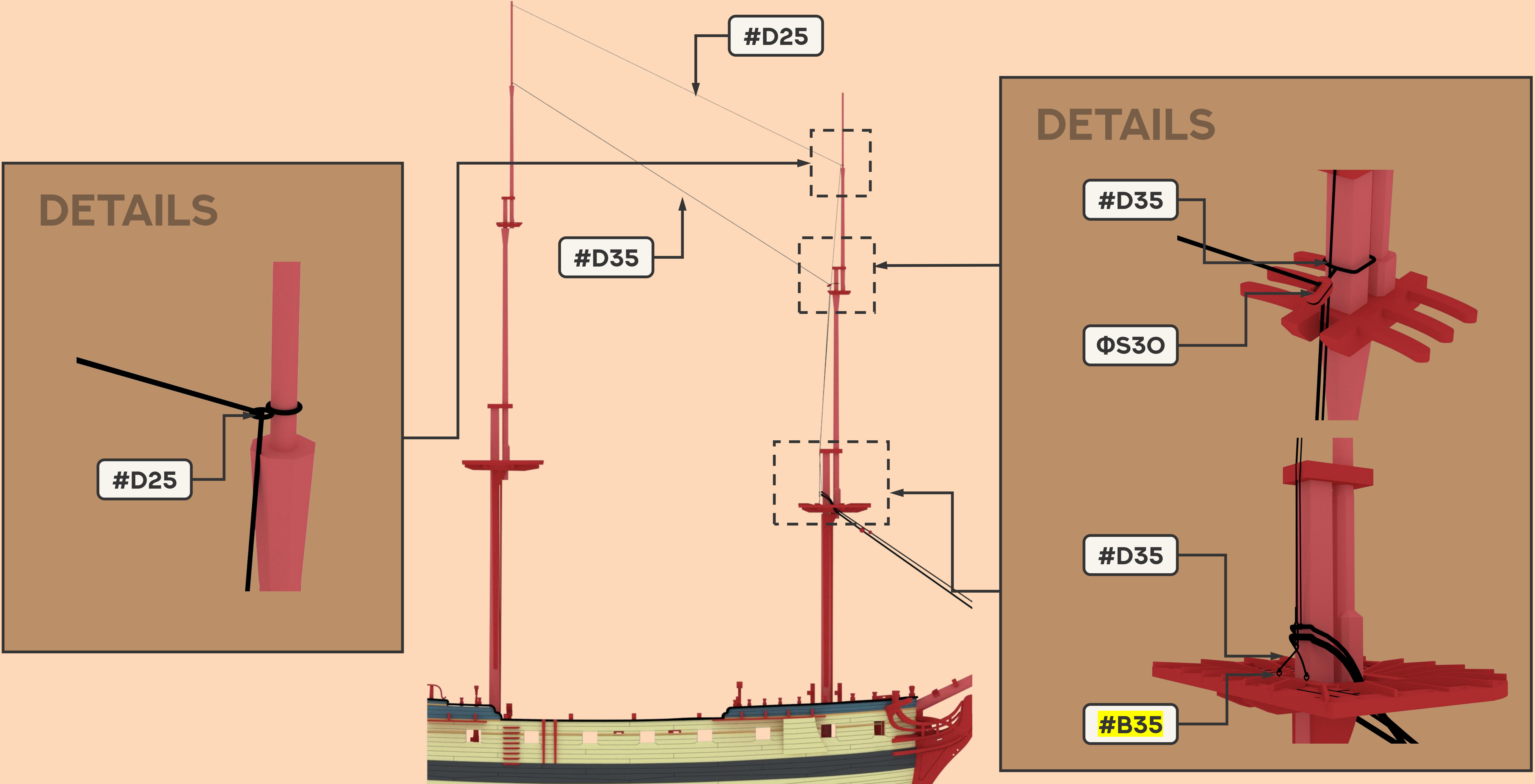

## 15. MAIN TOPGALLANT STAY & MAIN ROYAL STAY

### STEPS:

- 1, First make the main topgallant stay. Tie a 3mm single block on the head of fore topmast head, then tie one end on the main topgallant mast, and get the other side through the single block, let the thread go downwards.
- 2, Tie a 0.35mm thread on the two eye pins at the lower fore mast trees, and make a small ring on the top thread. Get the main topgallant stay attached the ring on the thread.
- 3, Make a ring using 0.25mm thread on the head of the fore topgallant mast. First connect the main royal stay with the royal mast, then get through this ring, go downwards, and tie on the back of the foremast stay.



# 16. MIZZEN SYAT, MIZZEN TOPMAST STAY & MIZZEN TOPGALLANT STAY

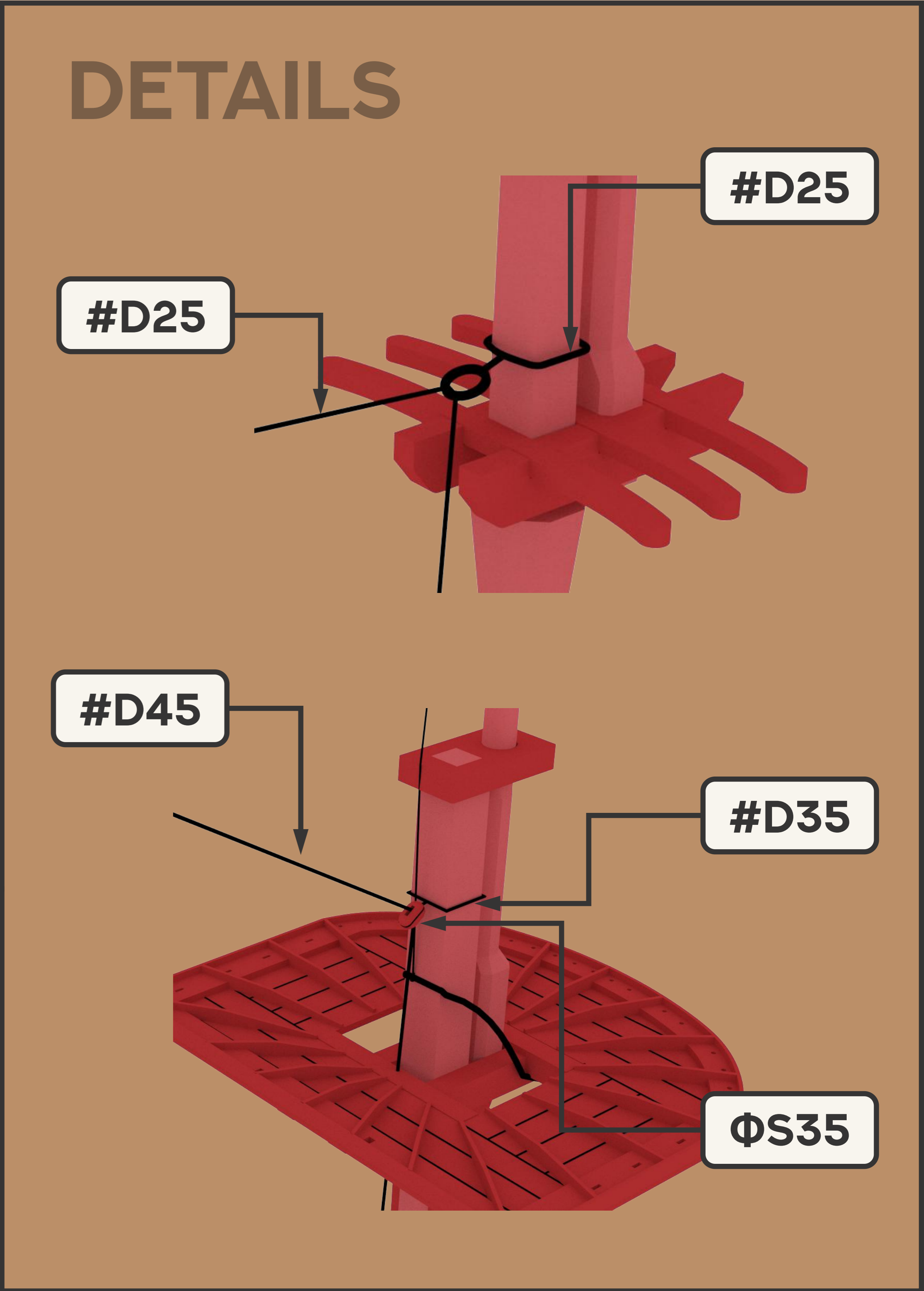
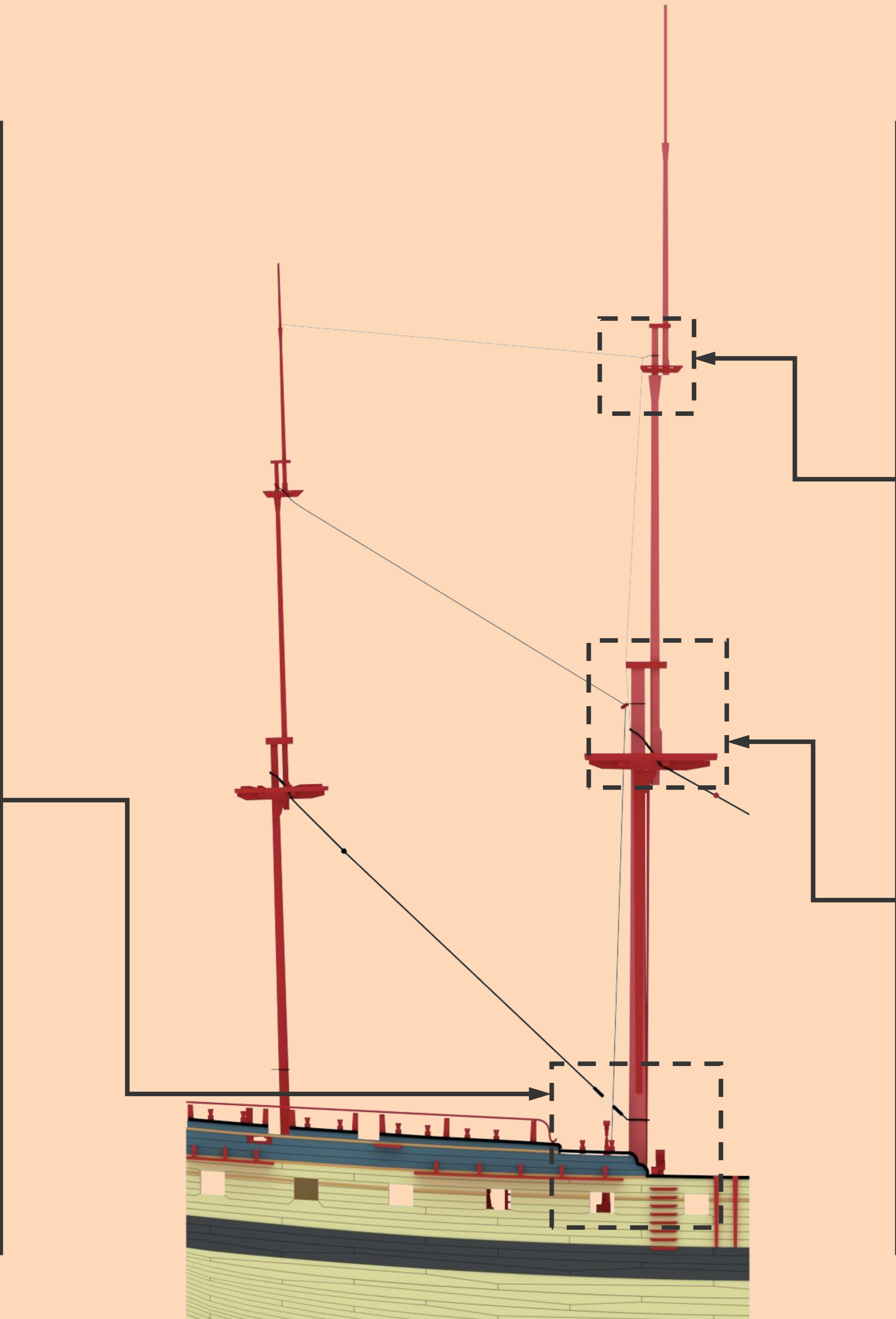
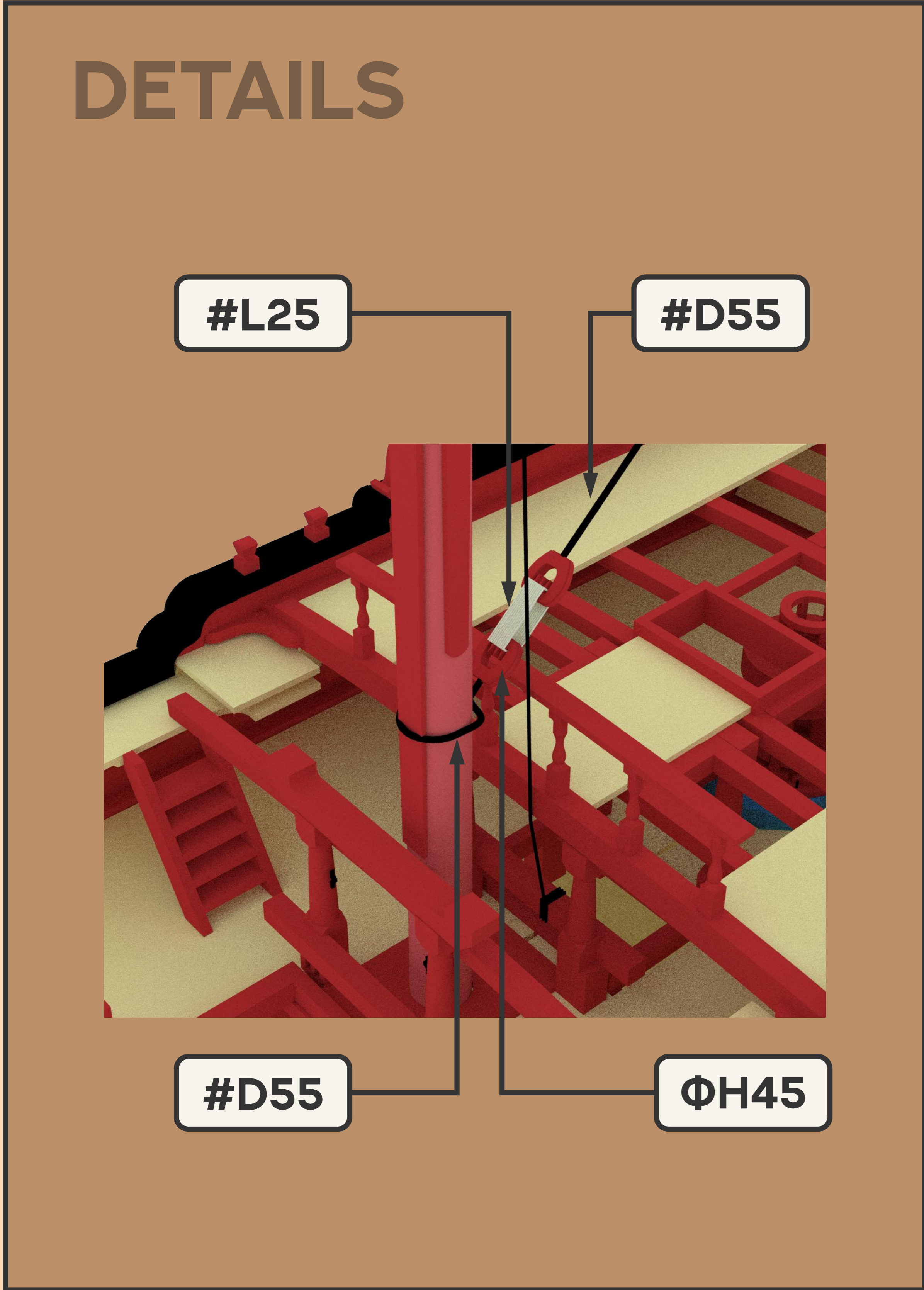

## 16. MIZZEN STAY, MIZZEN TOPMAST STAY & MIZZEN TOPGALLANT STAY

### STEPS:

- 1, Attach the mizzen stay on the mizzen lower trees in the same way as fore & main stay. Tie a 4.5 mm heart block at the end of it, then connect with the heart block on the main mast.
- 2, Tie a 3.5mm single block on the main mast head, get the mizzen topmast stay through the block, then goes down to the upper deck and tie on the jeer bitts.
- 3, Make a ring using 0.25mm thread on the head of main topmast head. Get the topgallant stay through this ring, and tie on the back of the main stay.

# STEP 10-16

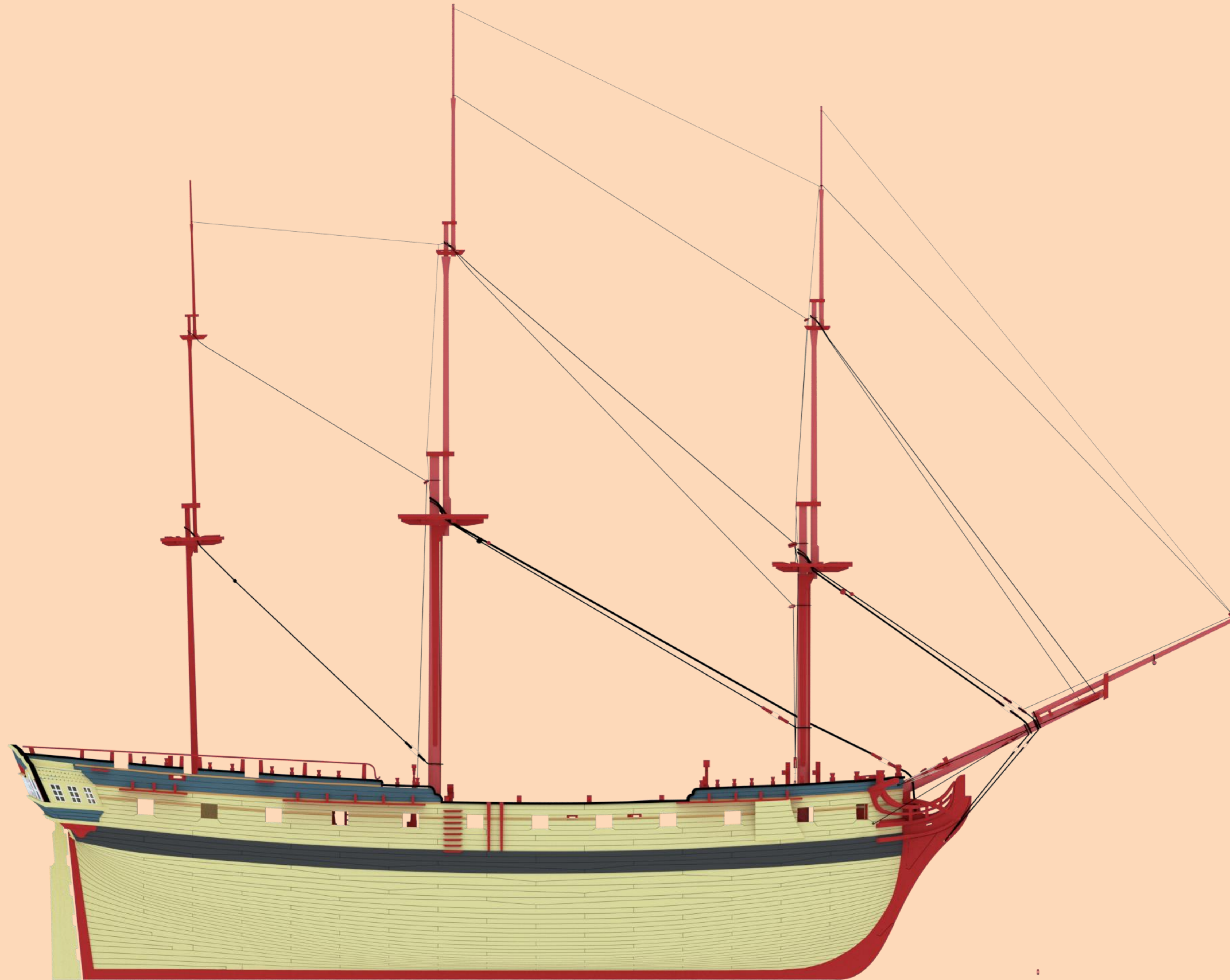

# CONTENTS SO FAR

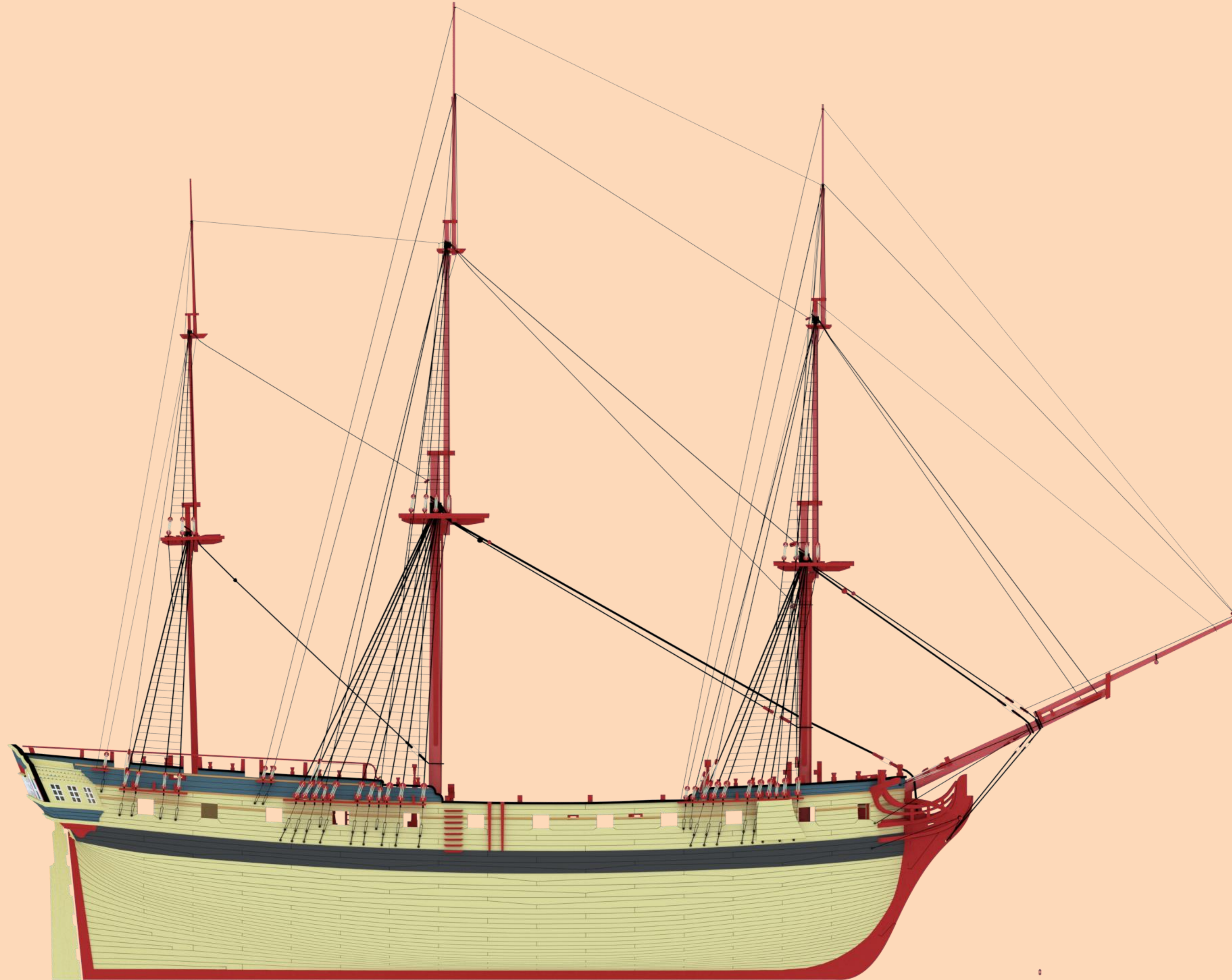

# 17. FORE YARD JEERS

## DETAILS

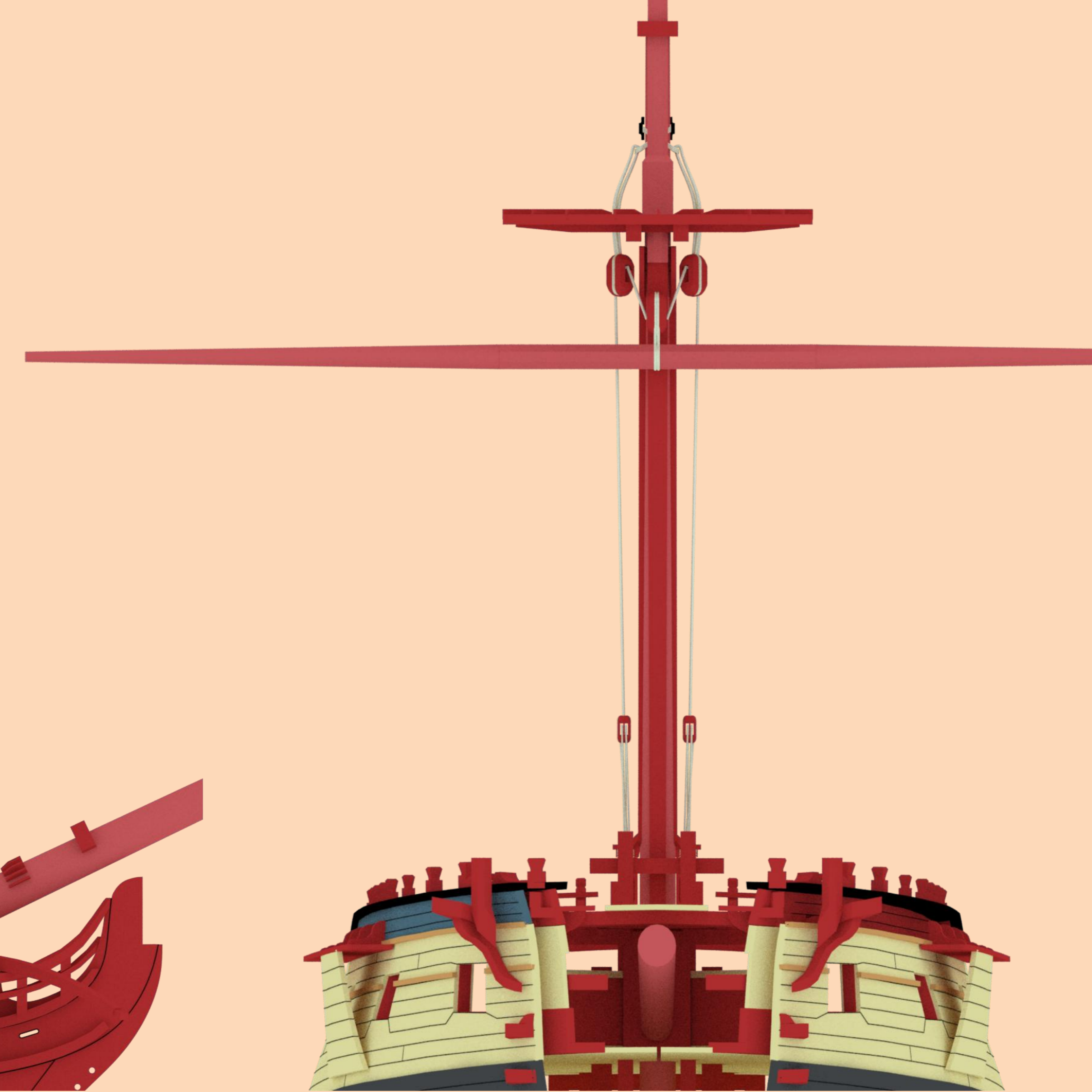
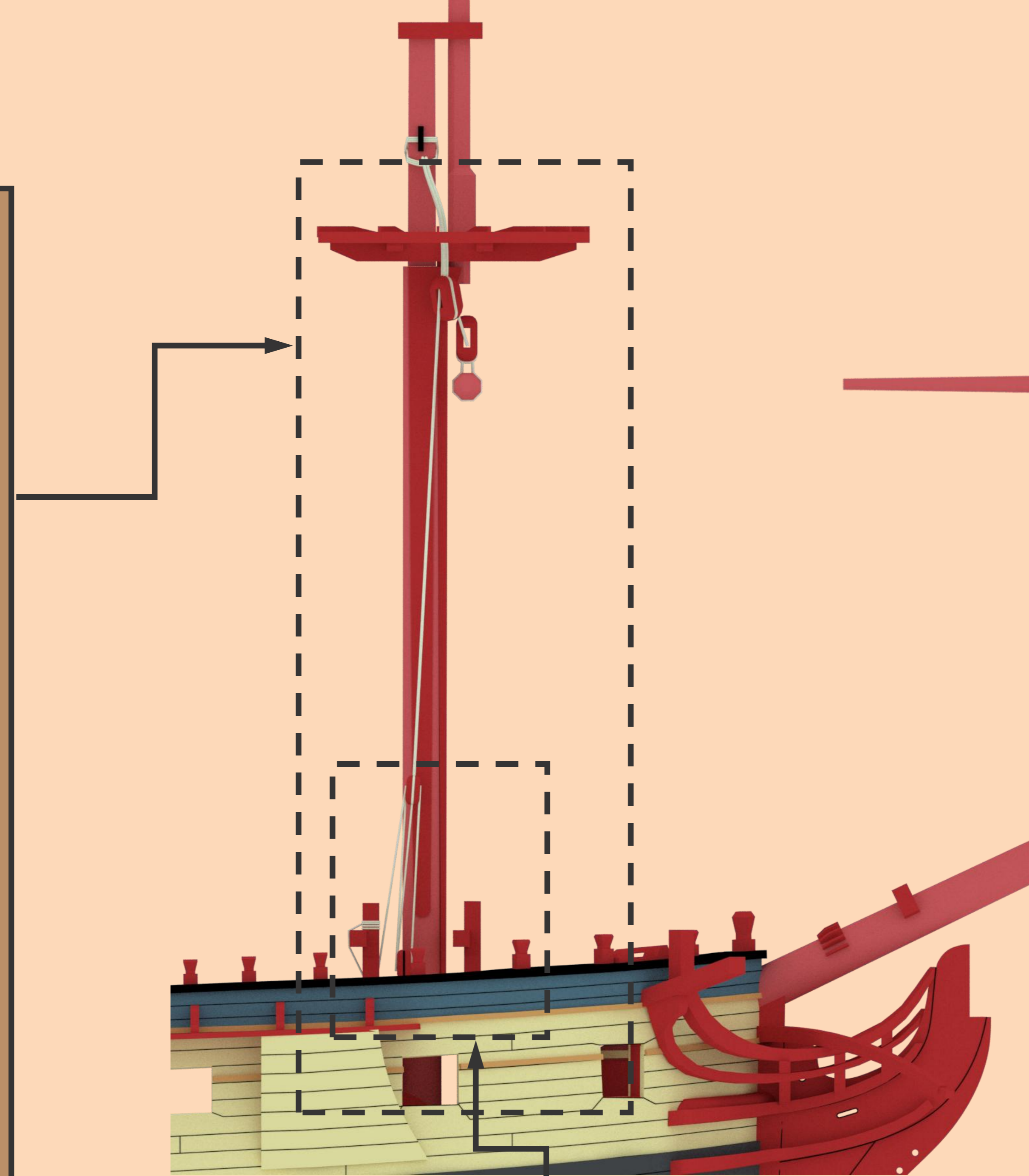
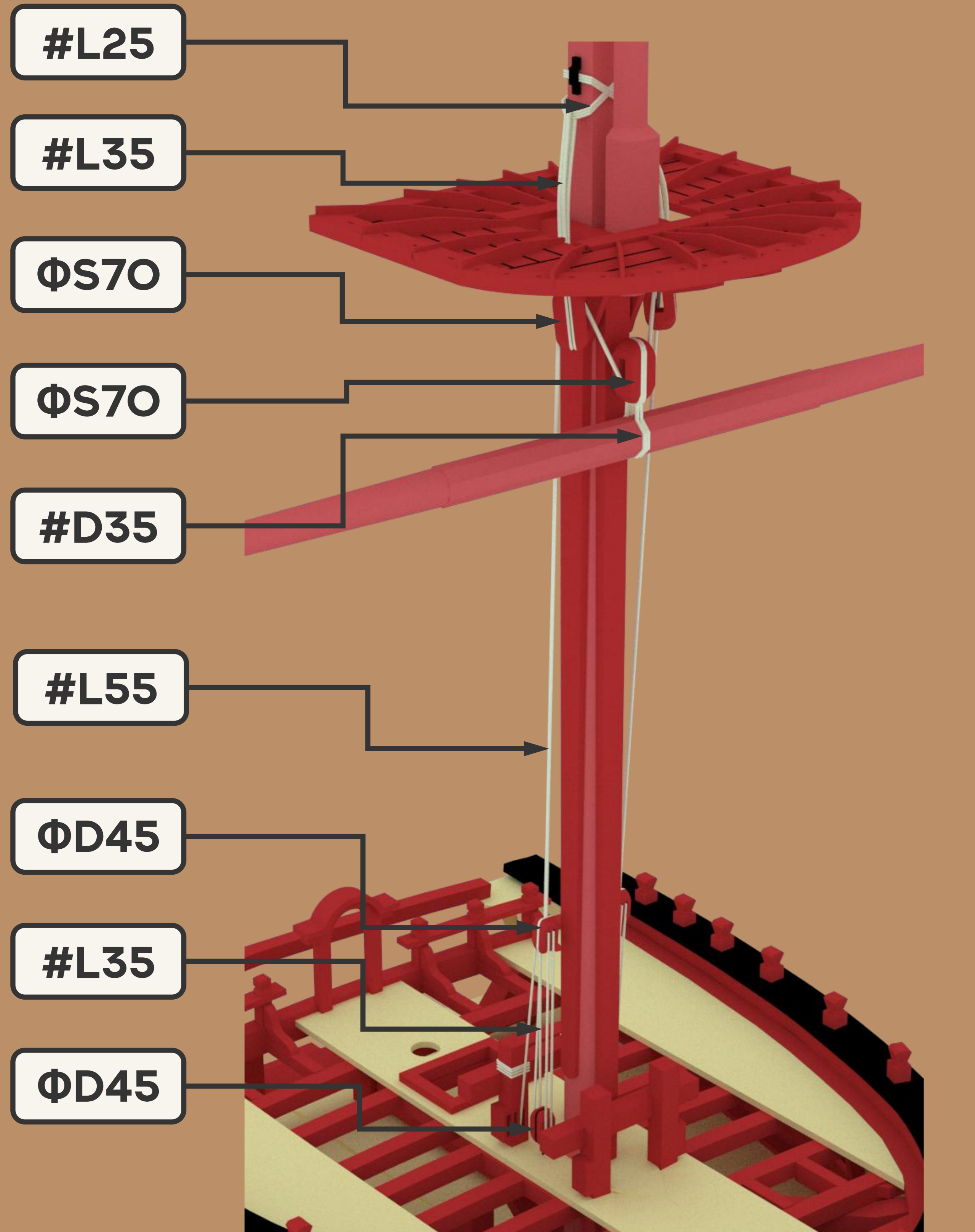

## DETAILS

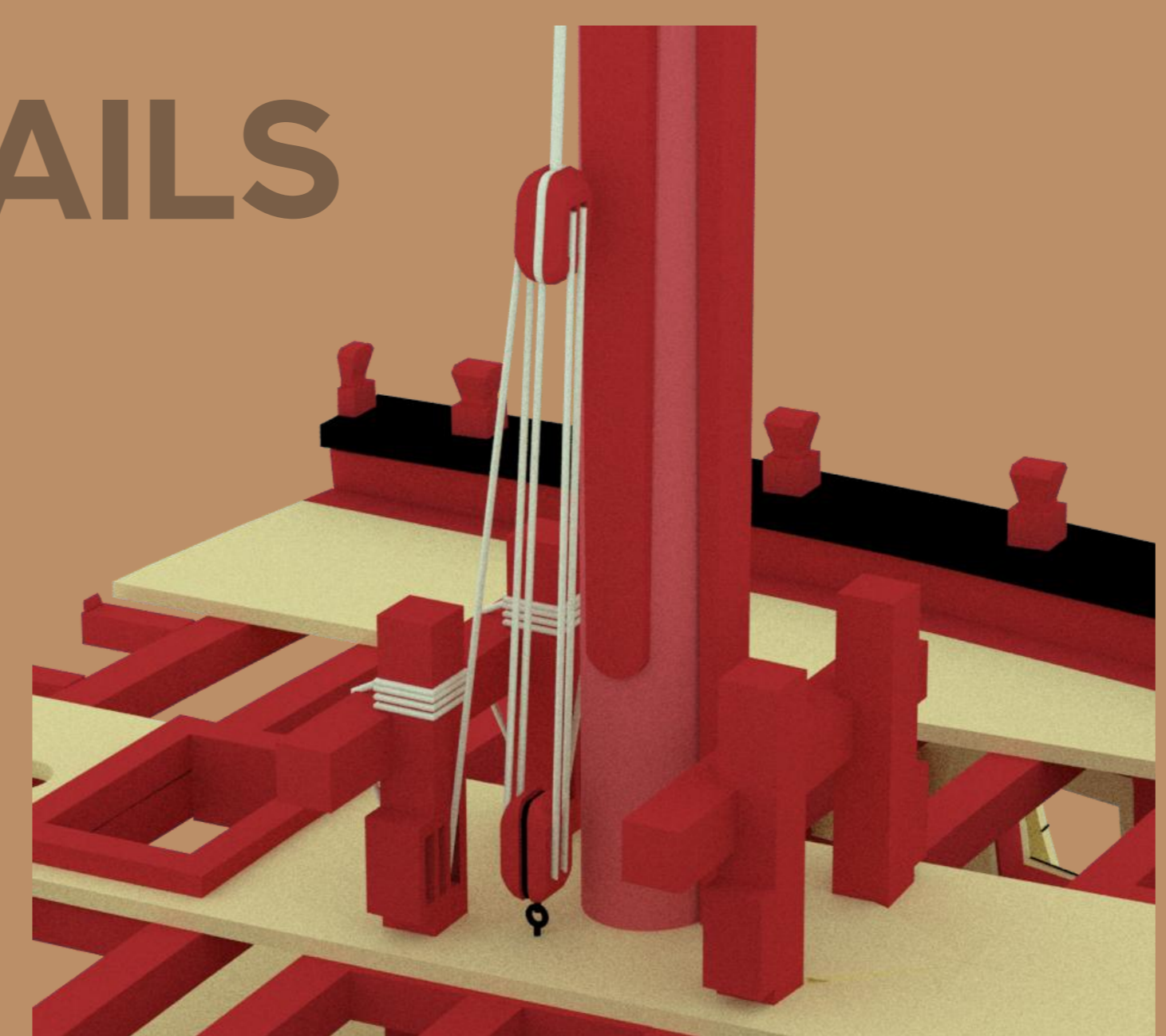

# 18. FORE YARD TRUSS PENDANTS

## DETAILS

#L55

ΦD30

#L25

ΦD30

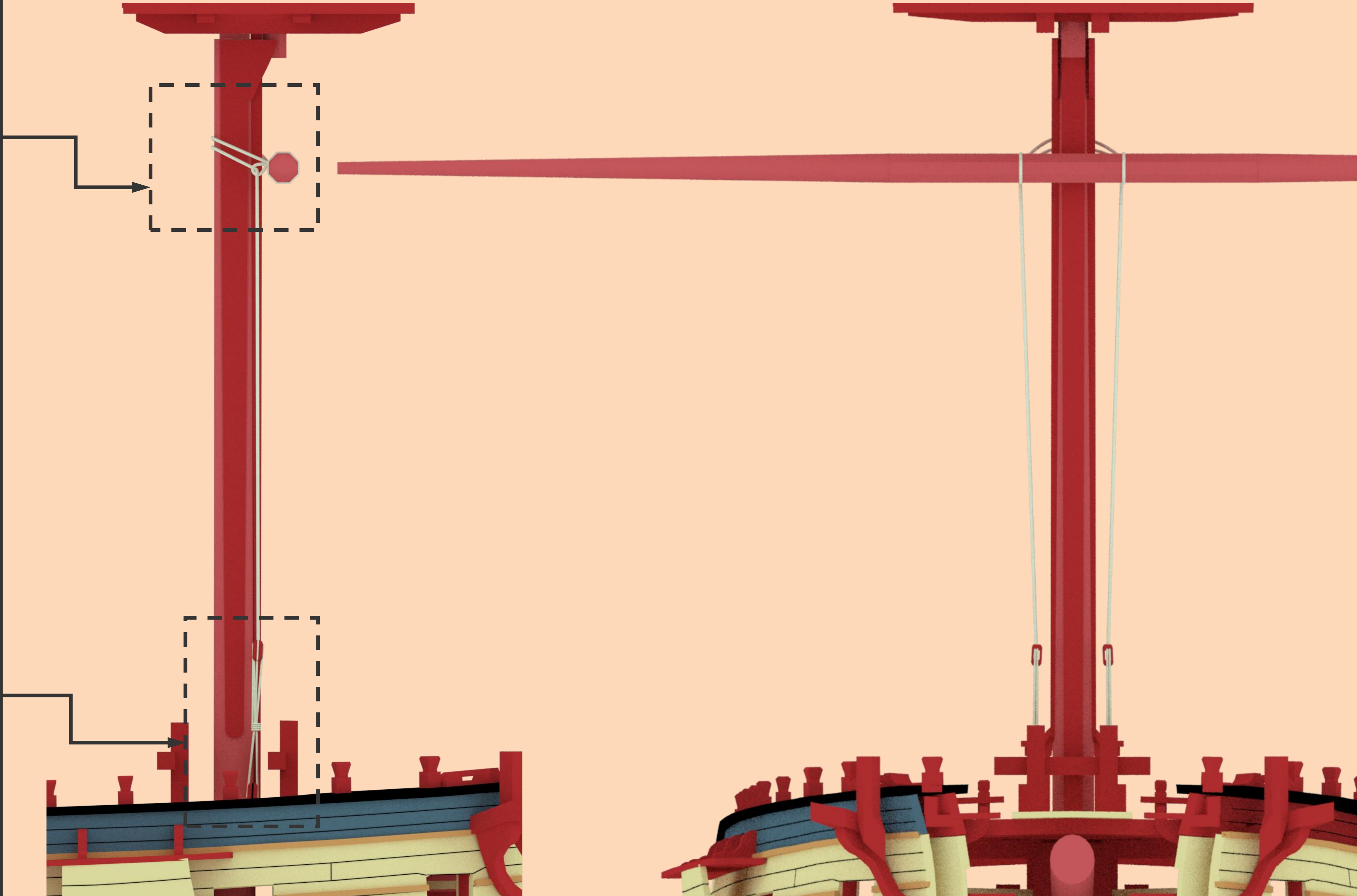

# 20. FORE TOPSAIL YARD TYE & HALLIARD

## DETAILS

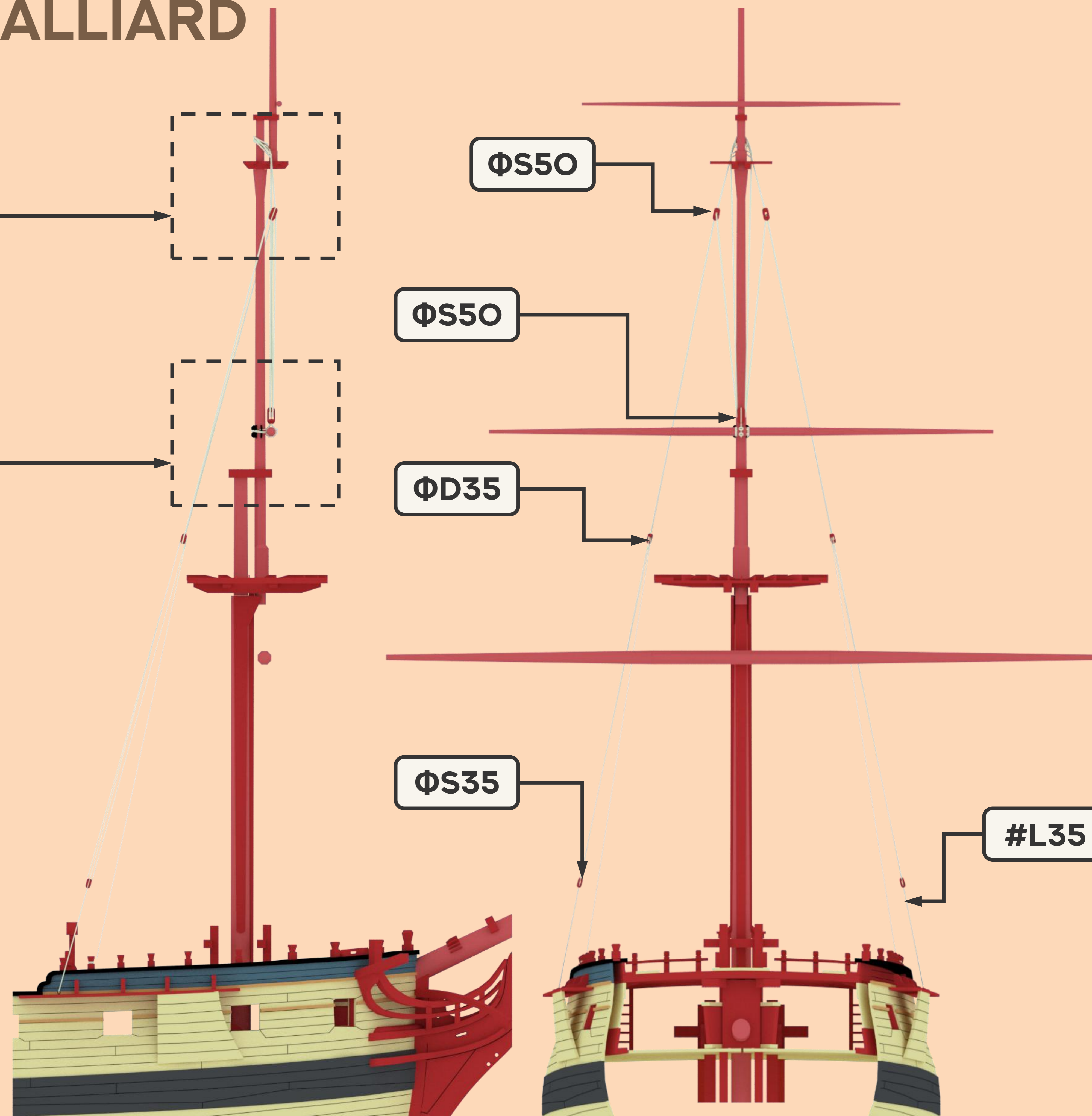
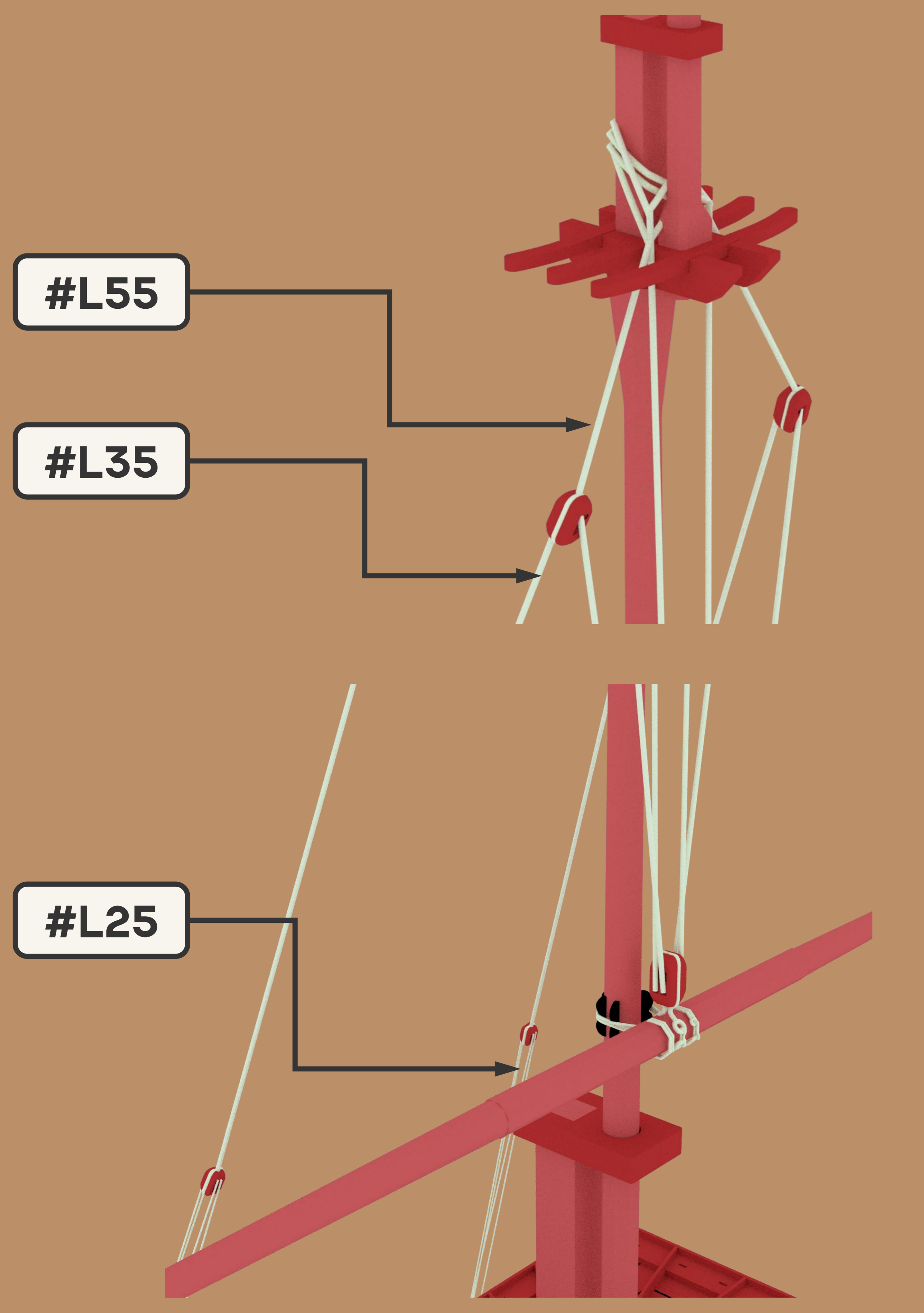

# 21. FORE TOPSAIL YARD LIFT

## DETAILS

#L35

#L35

#L35

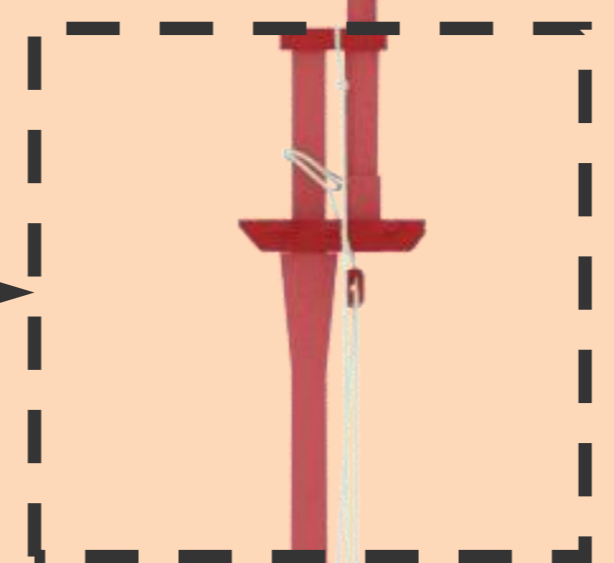
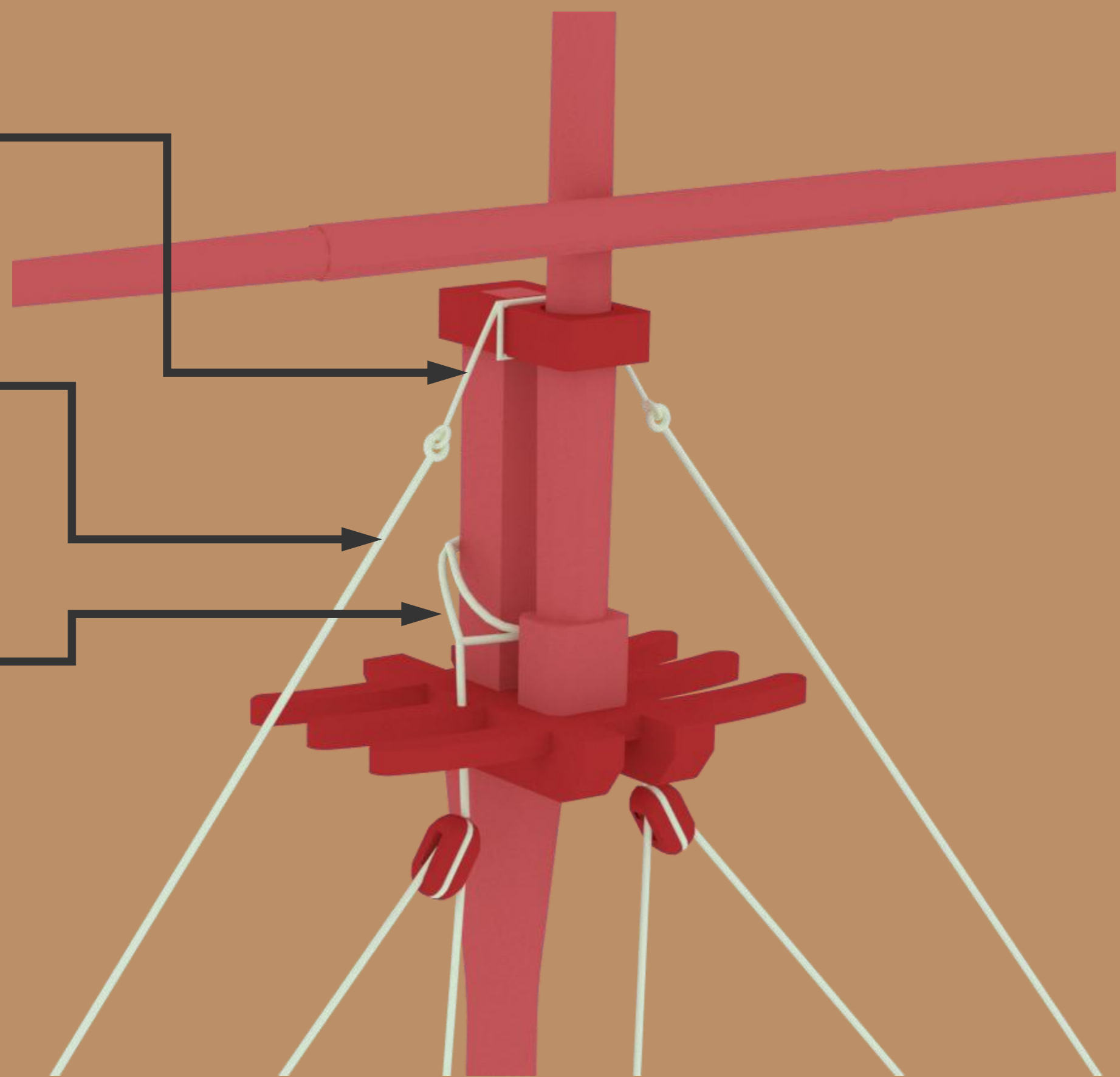

ΦS35

ΦS35

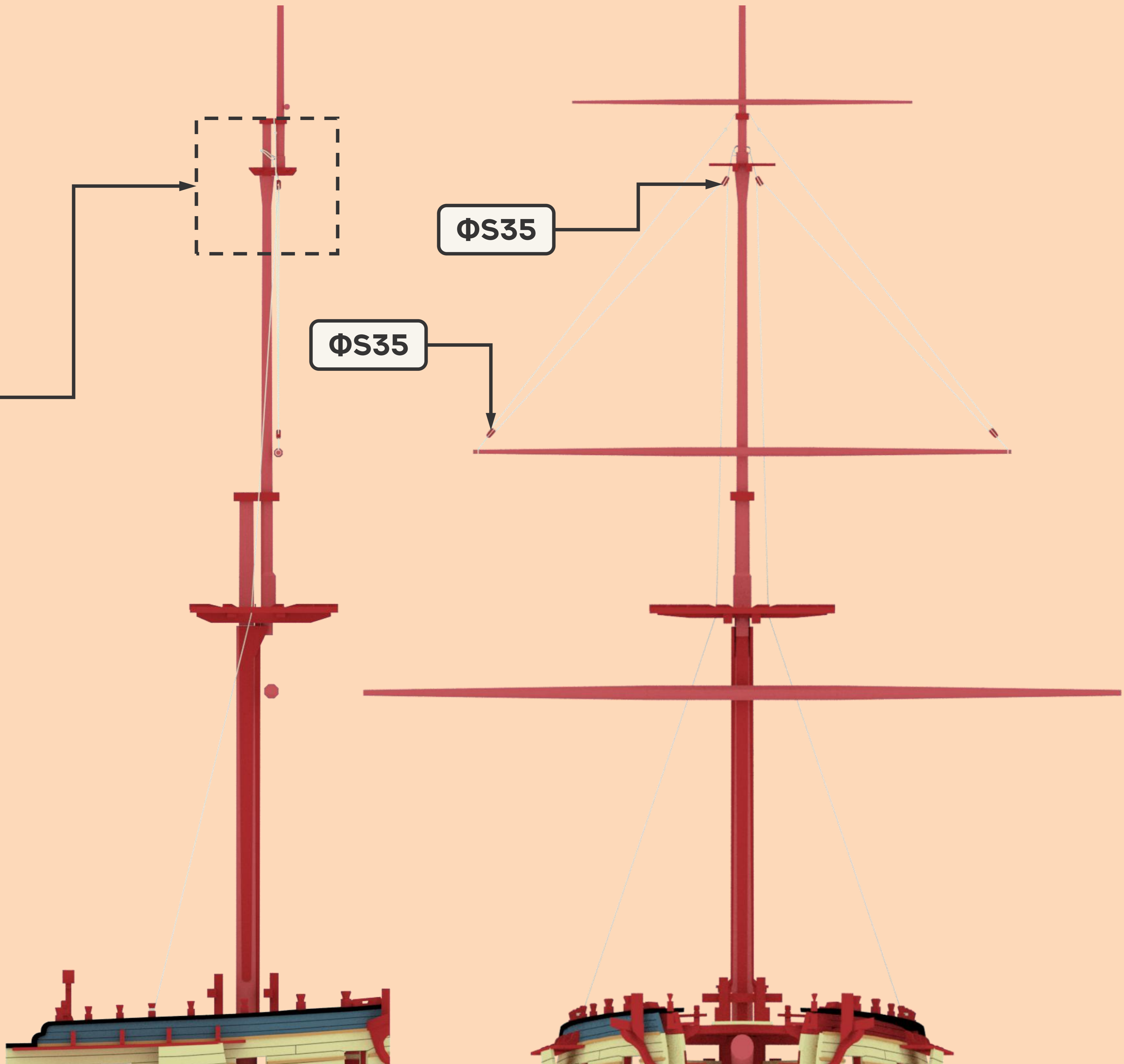



# 3D VIEW FOR STEP 20, 21

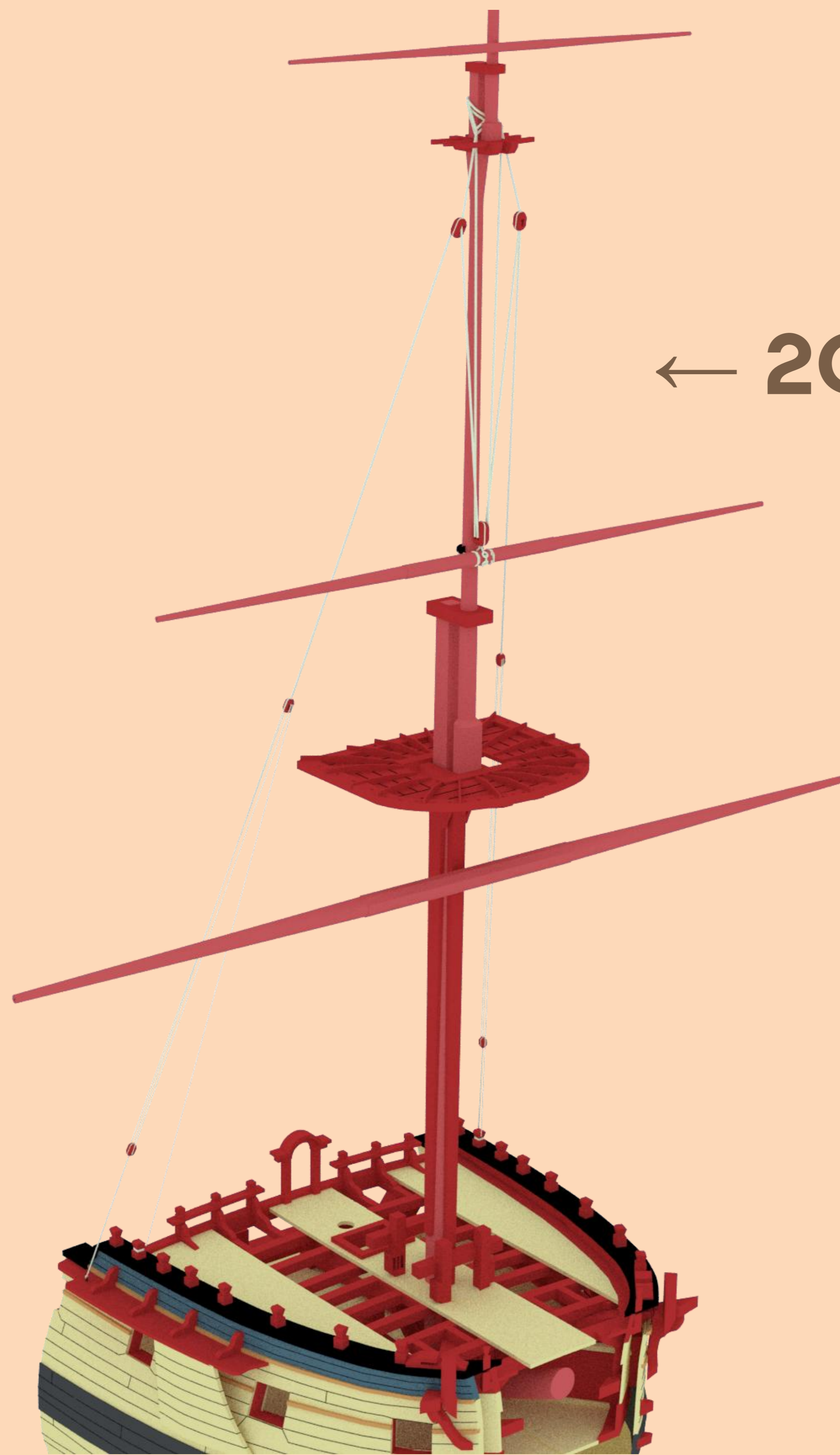

← 20

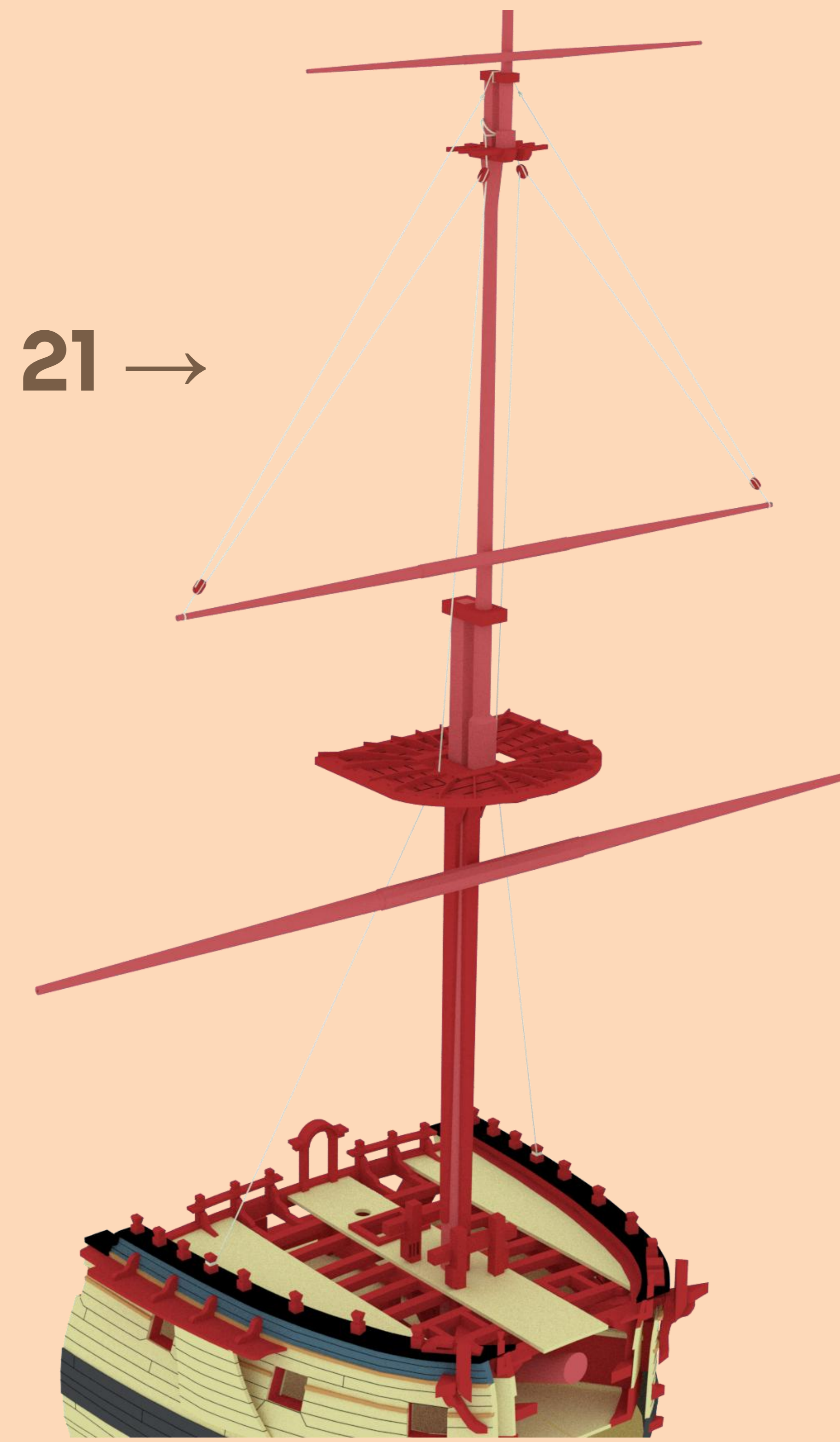

21 →

# 22. FORE TOPGALLANT YARD HALLIARD

ΦS30

#L25

ΦS30

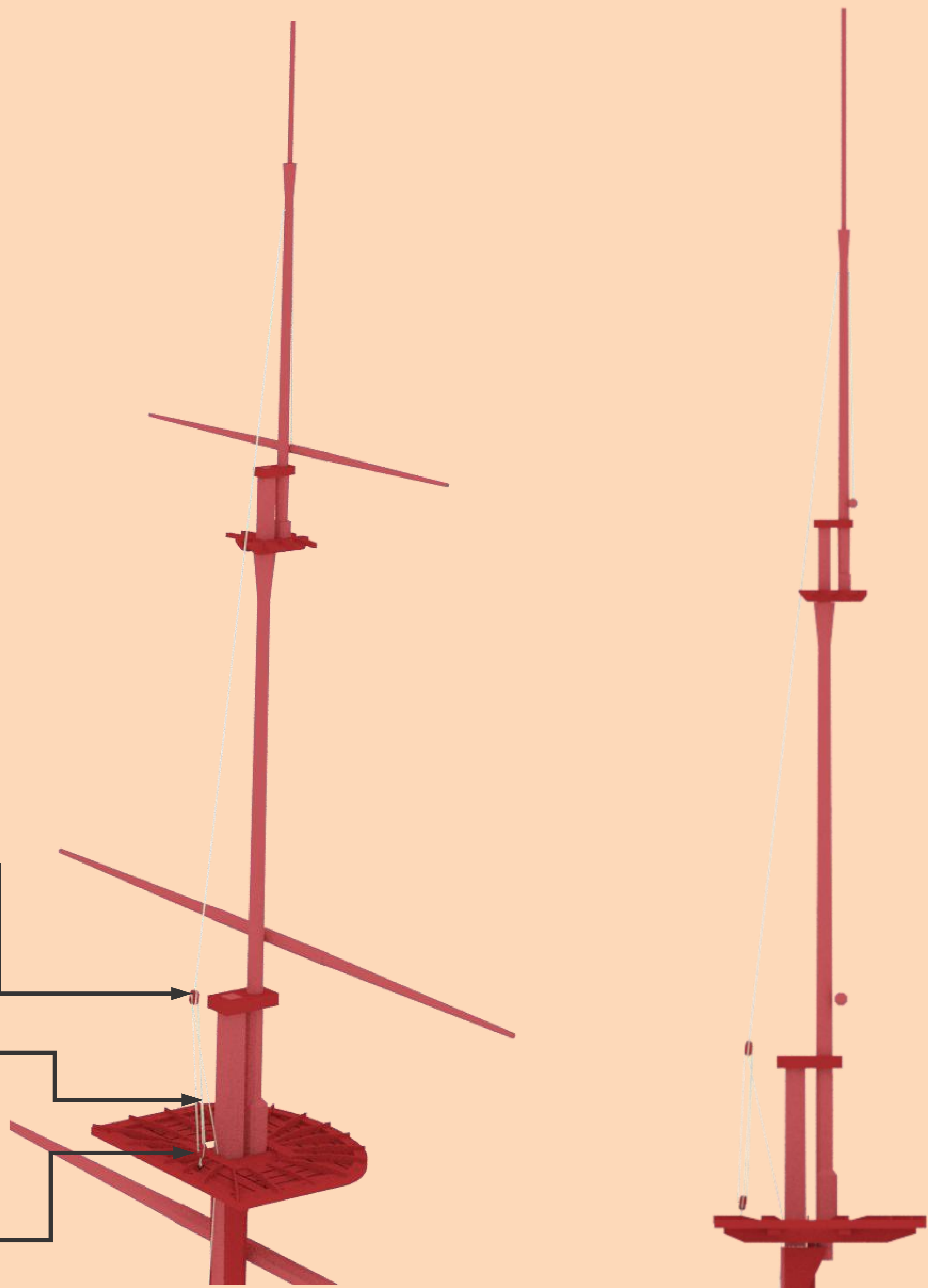

# 23. FORE TOPGALLANT YARD LIFT

## DETAILS

#L25

#L25

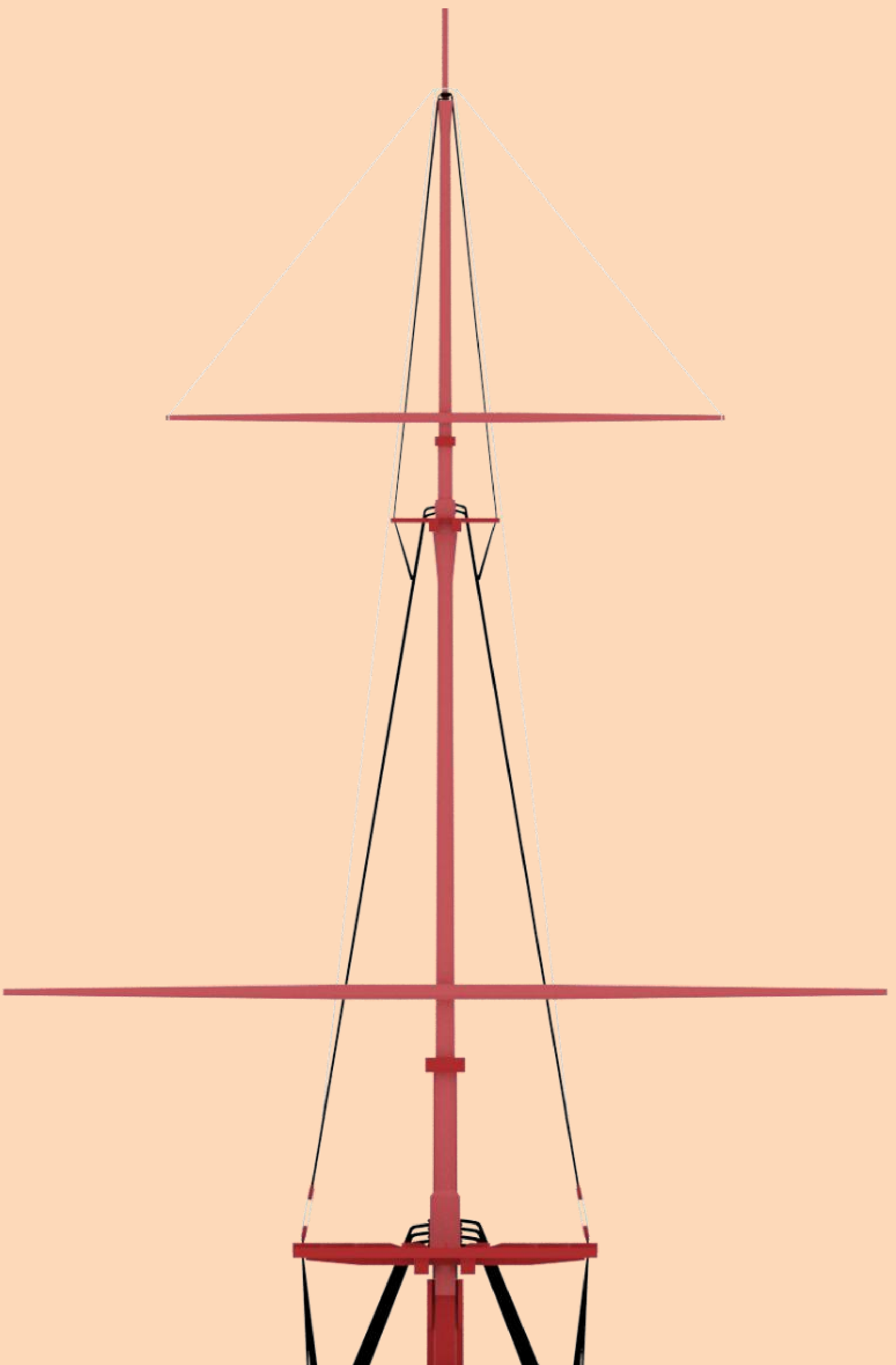
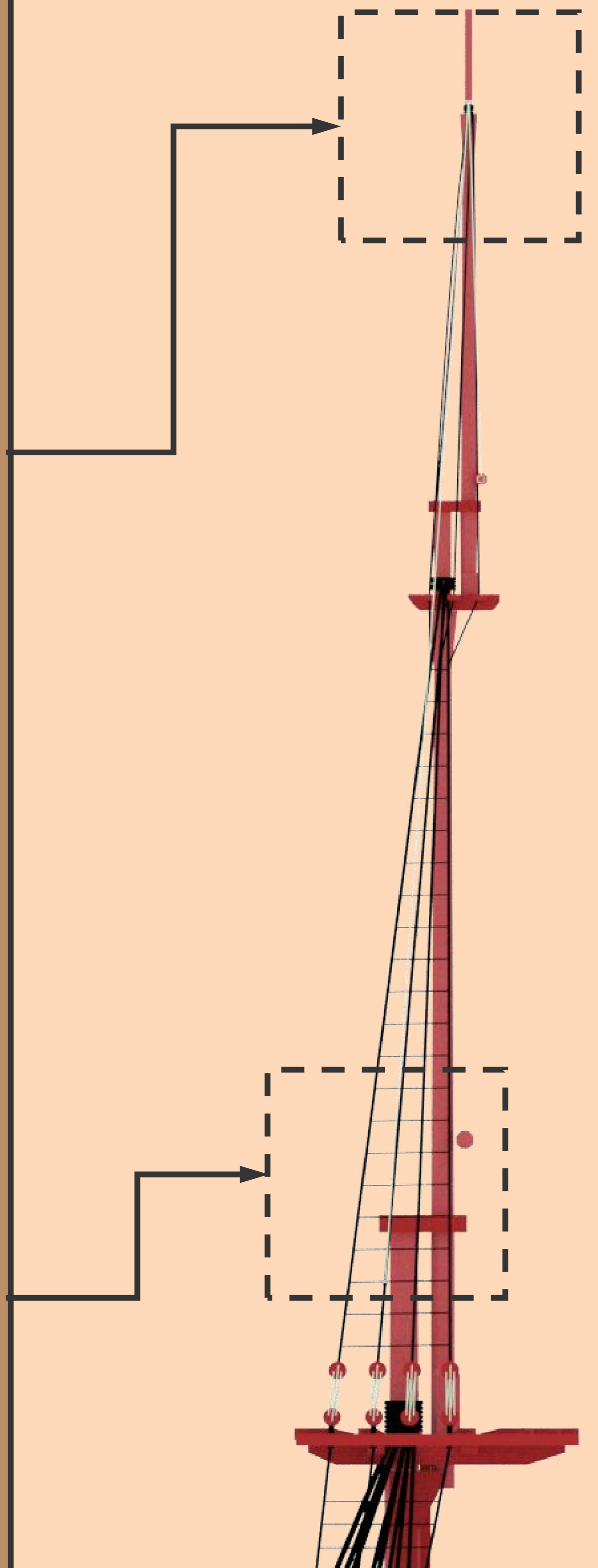
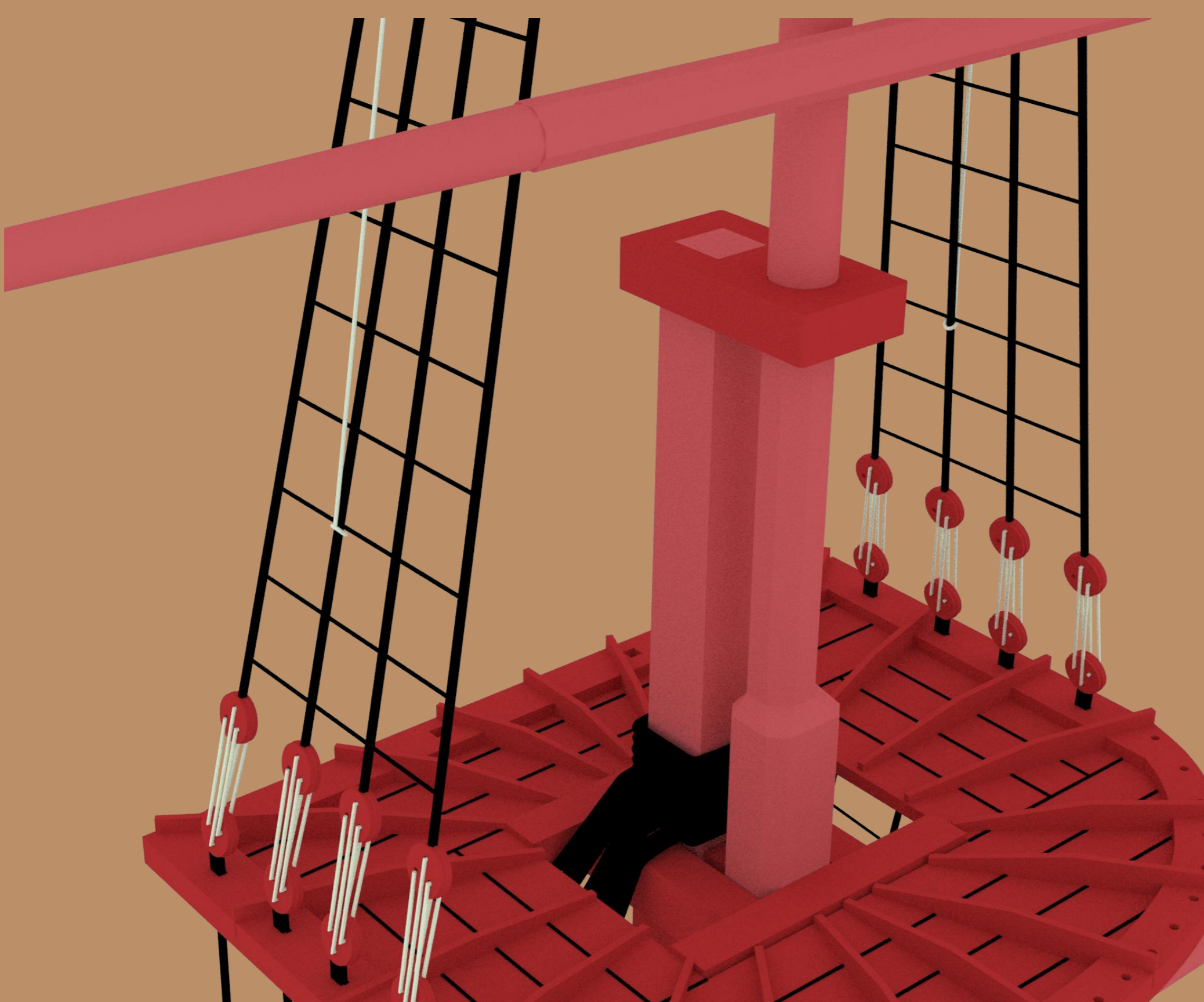
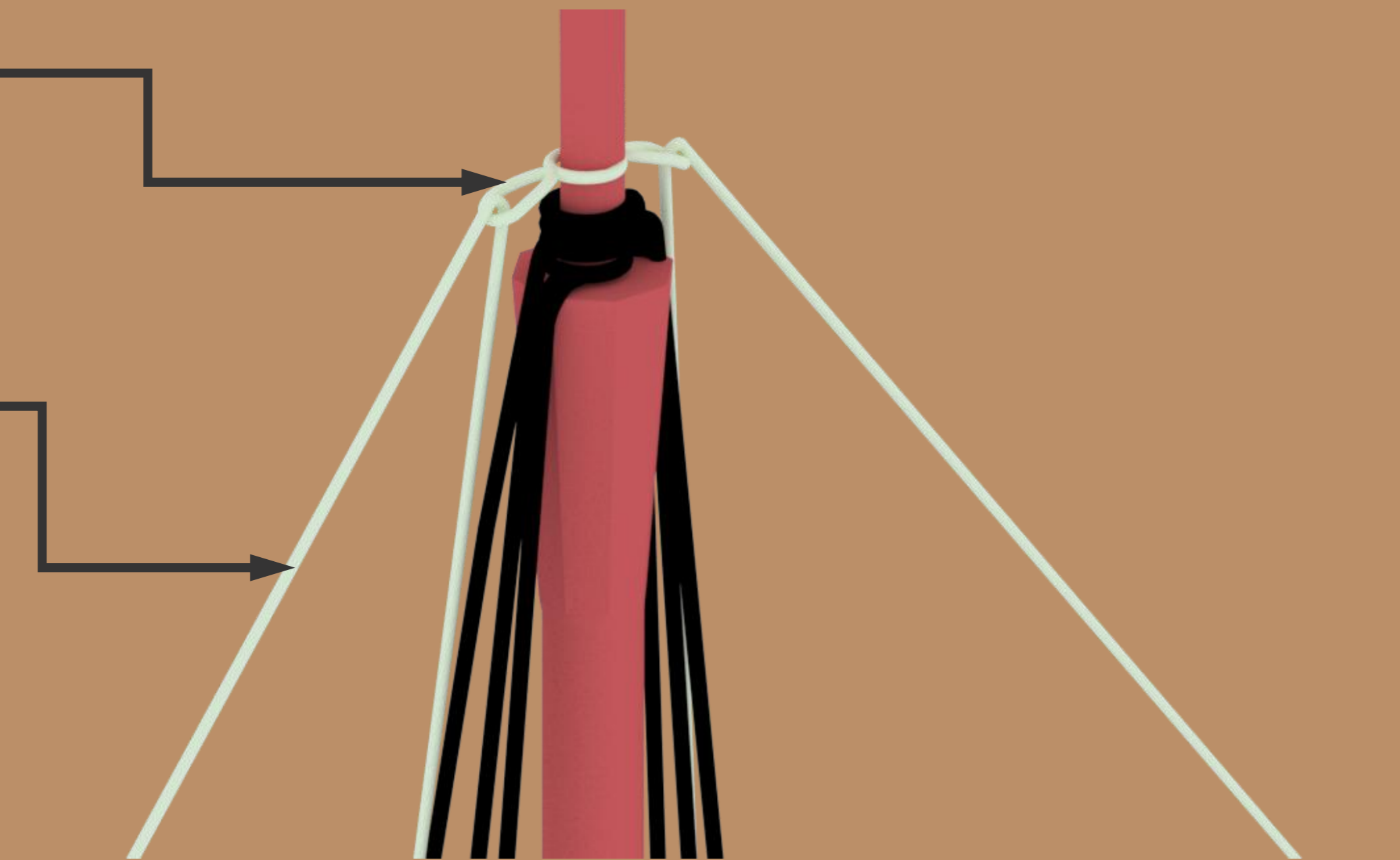

# 24. MAIN YARD TRUSS PENDANTS

## DETAILS

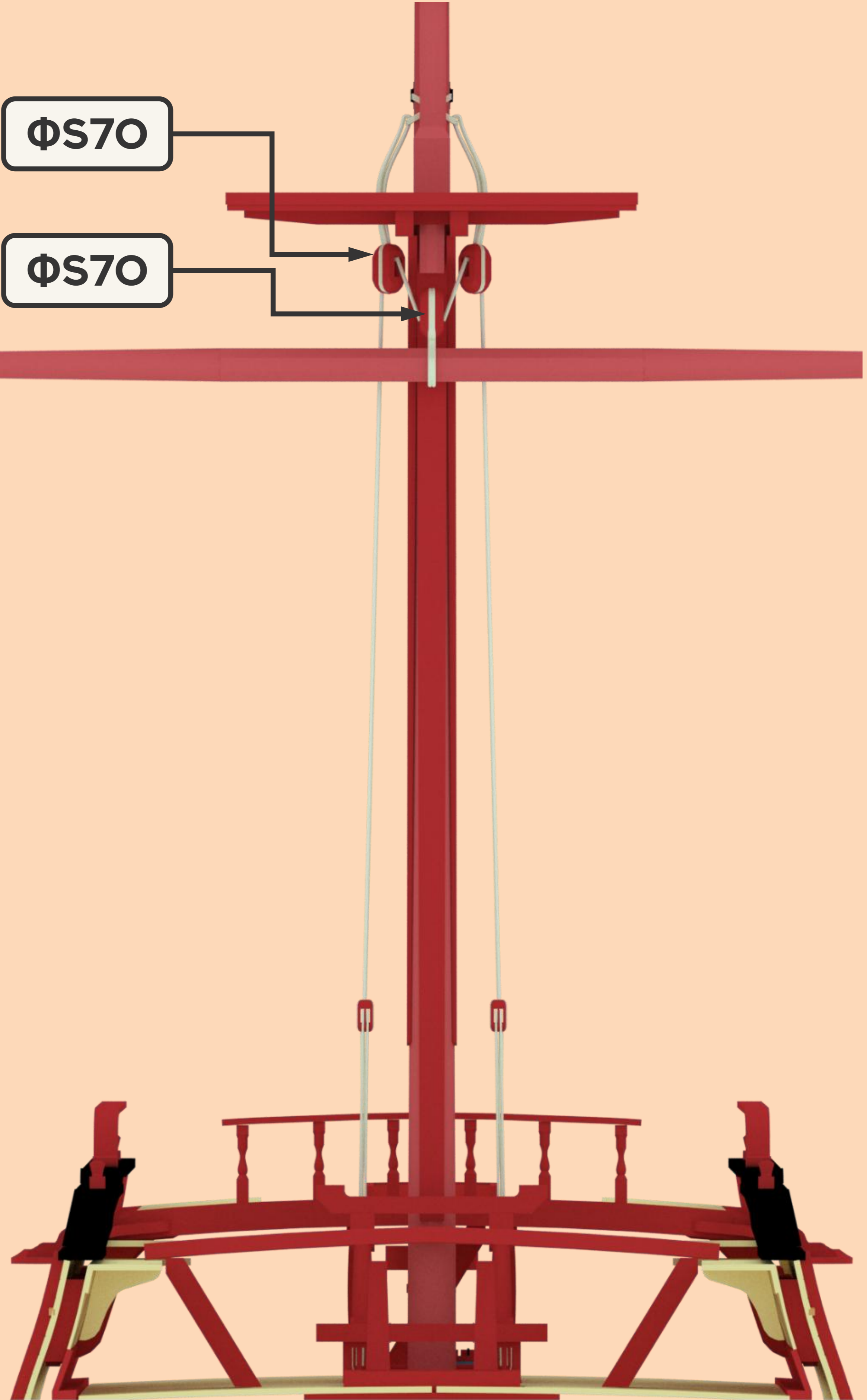
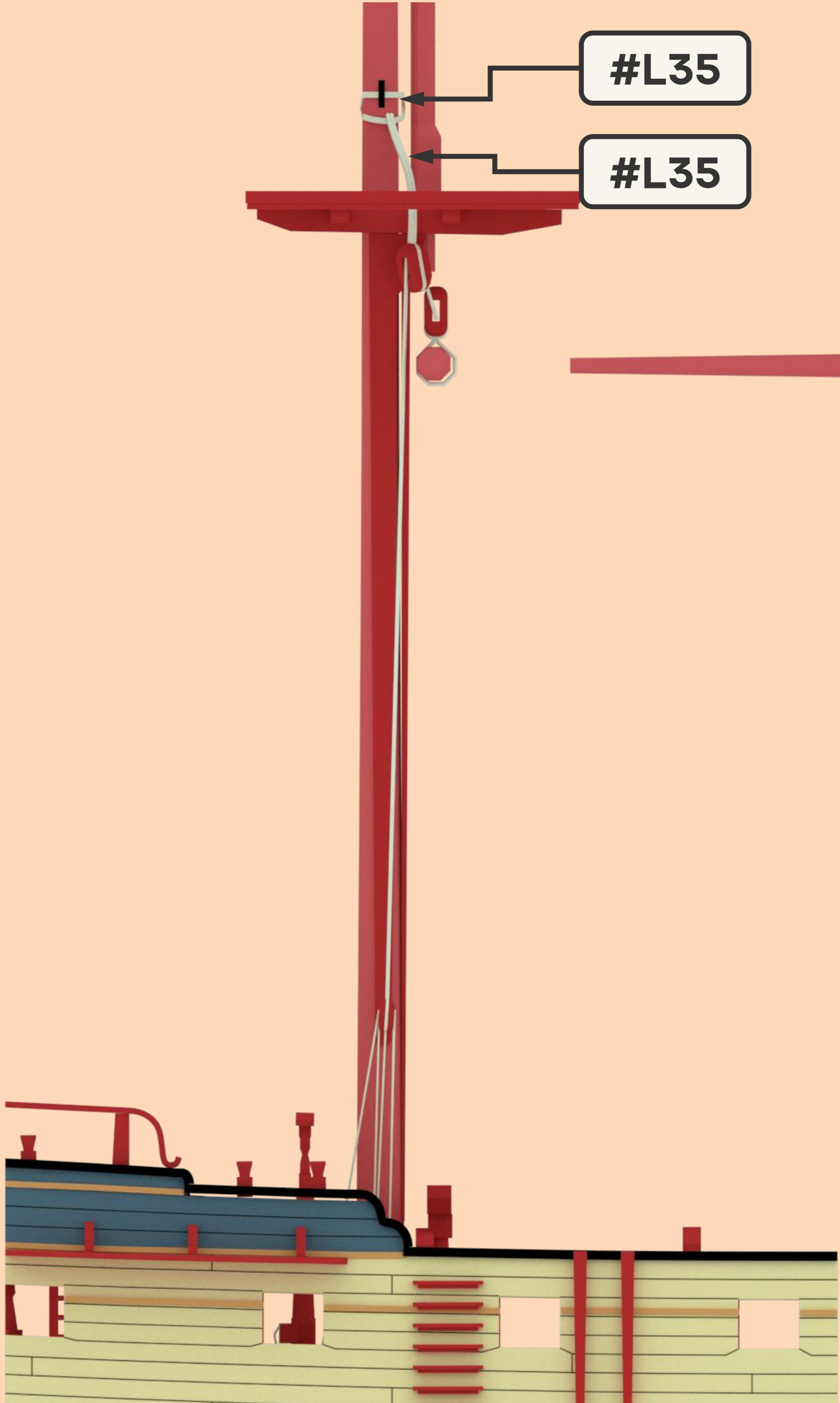
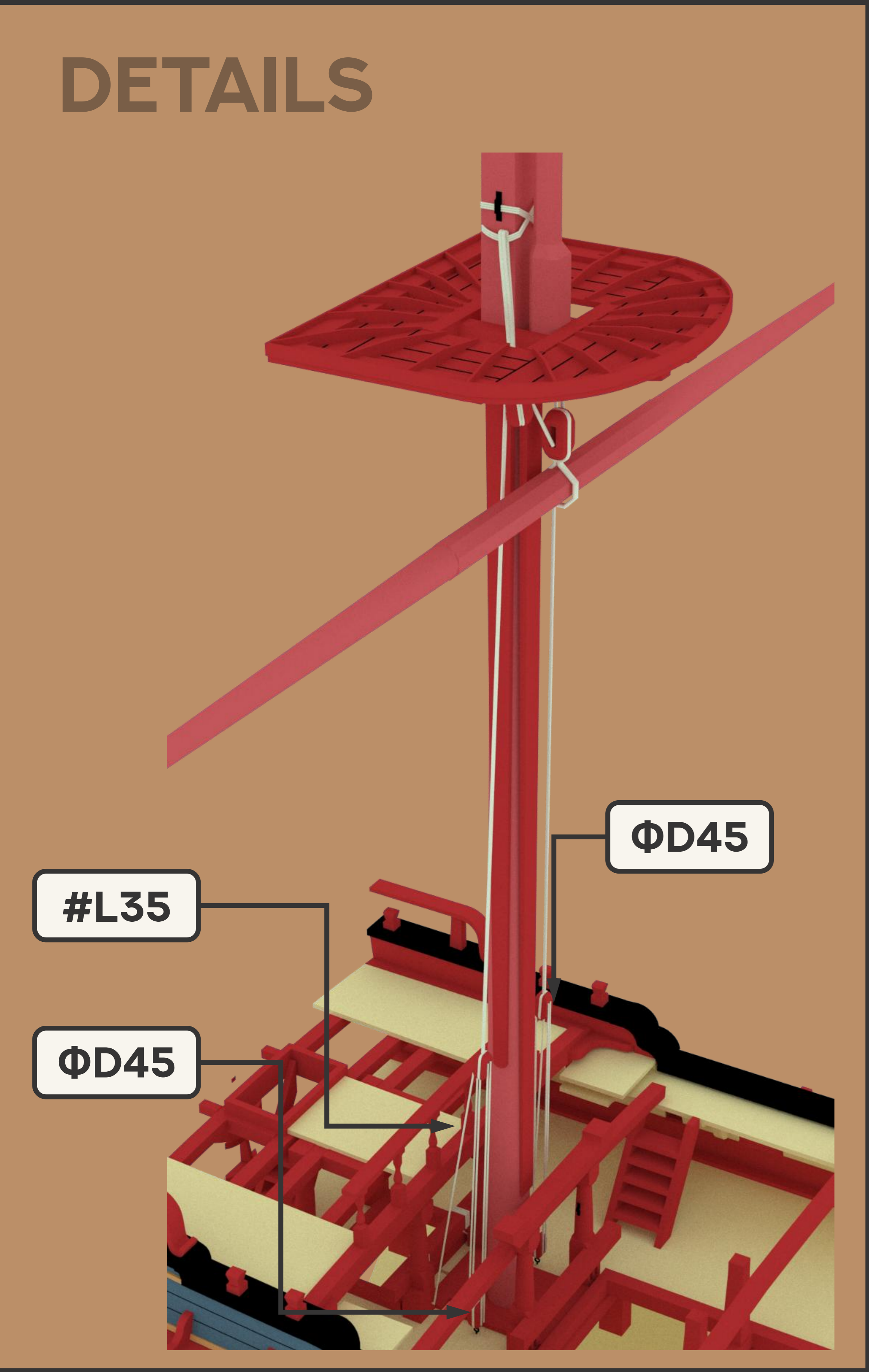

# 25. MAIN YARD JEERS

## DETAILS

#L55

ΦD30

#L25

ΦD30

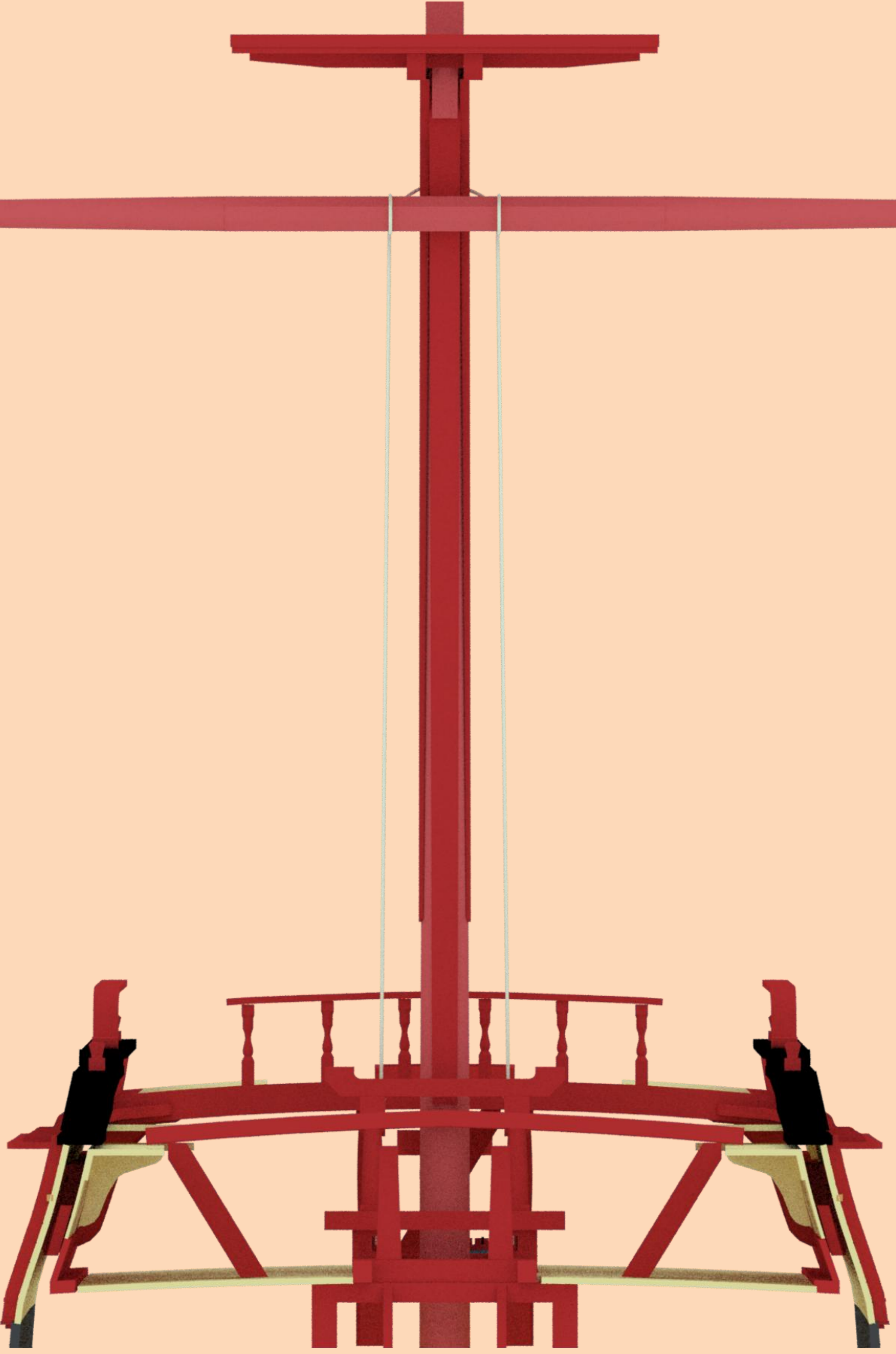
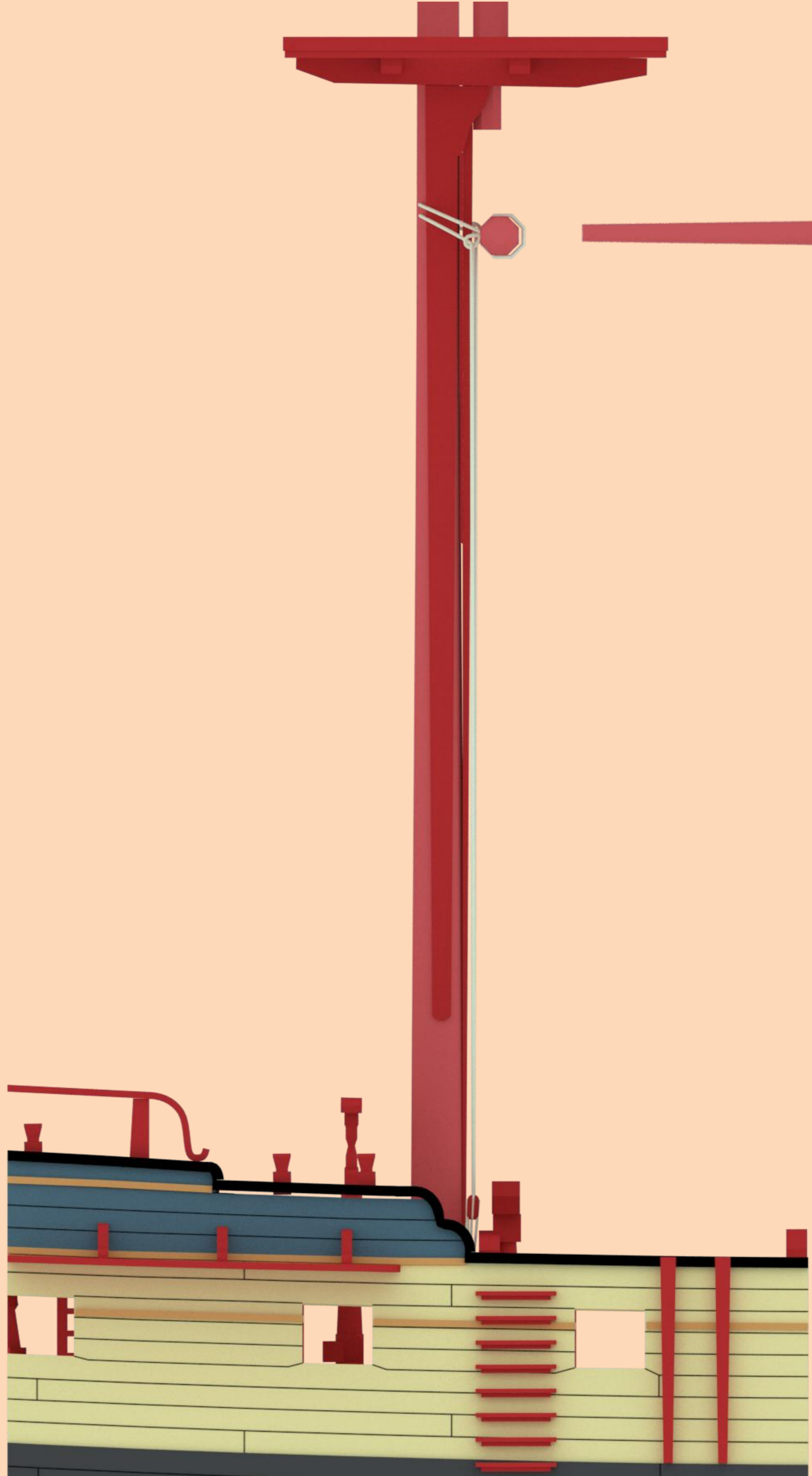

# 26. MAIN YARD LIFT

## DETAILS

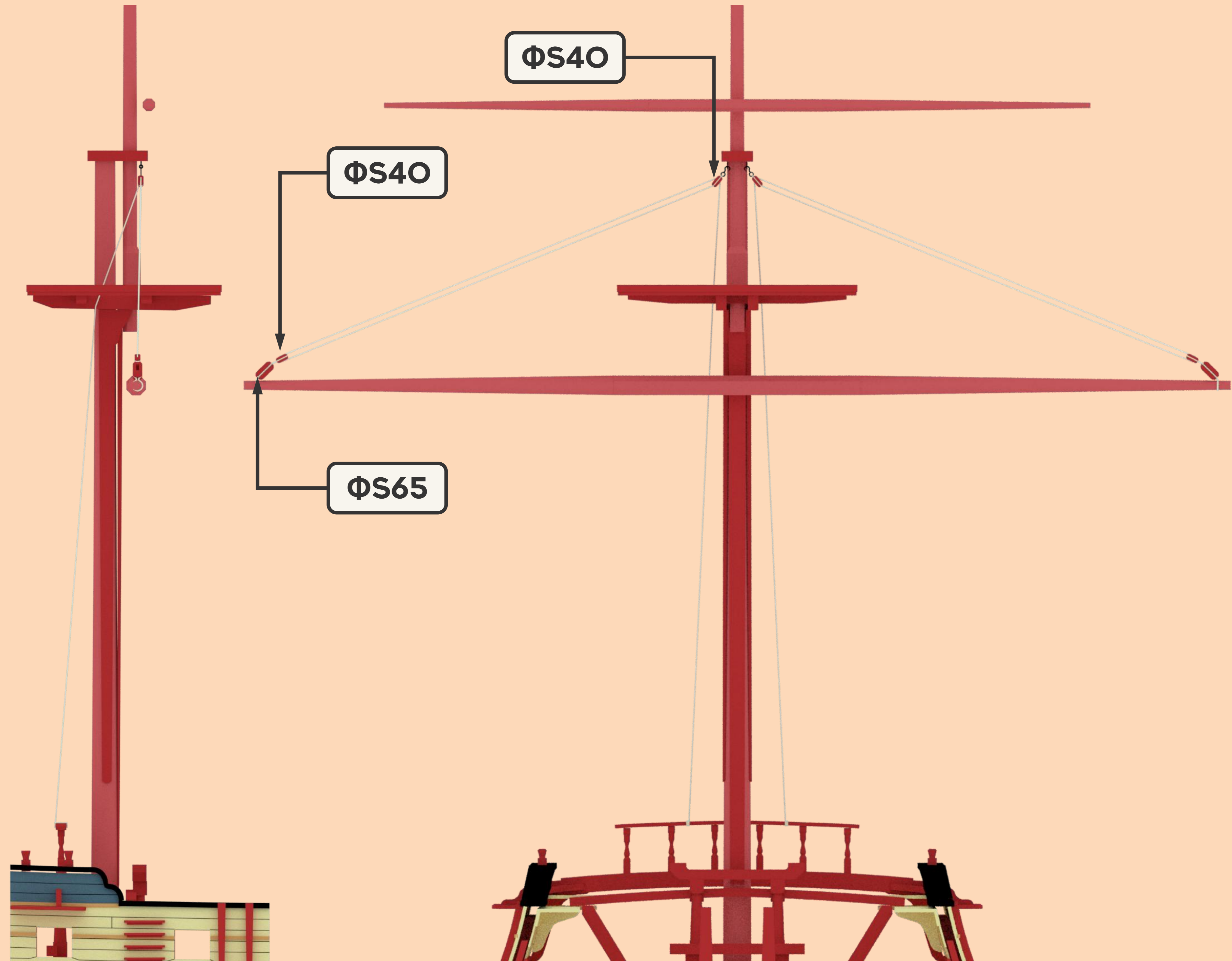
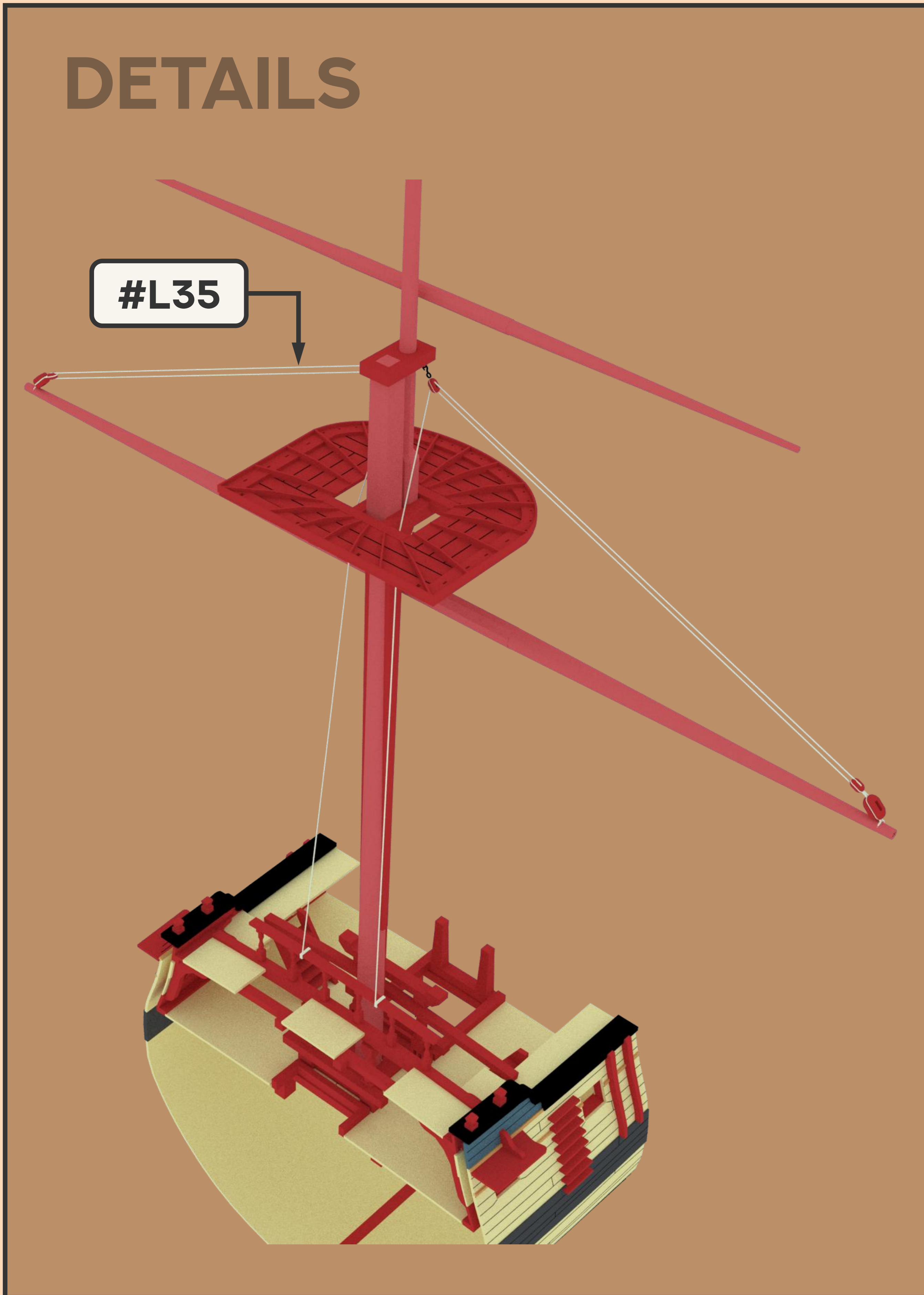

# 27. MAIN TOPSAIL YARD TYE & HALLIARD

## DETAILS

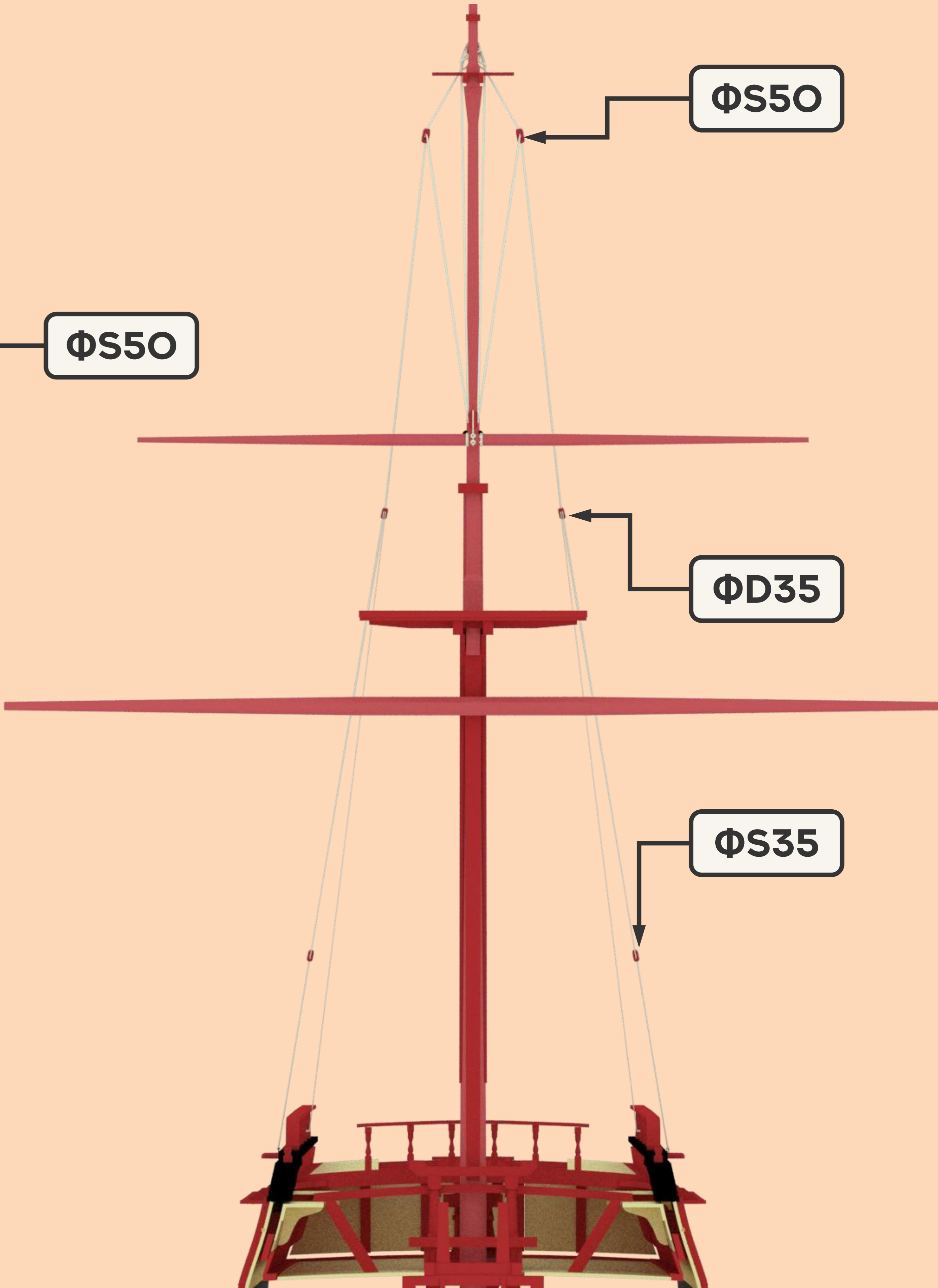
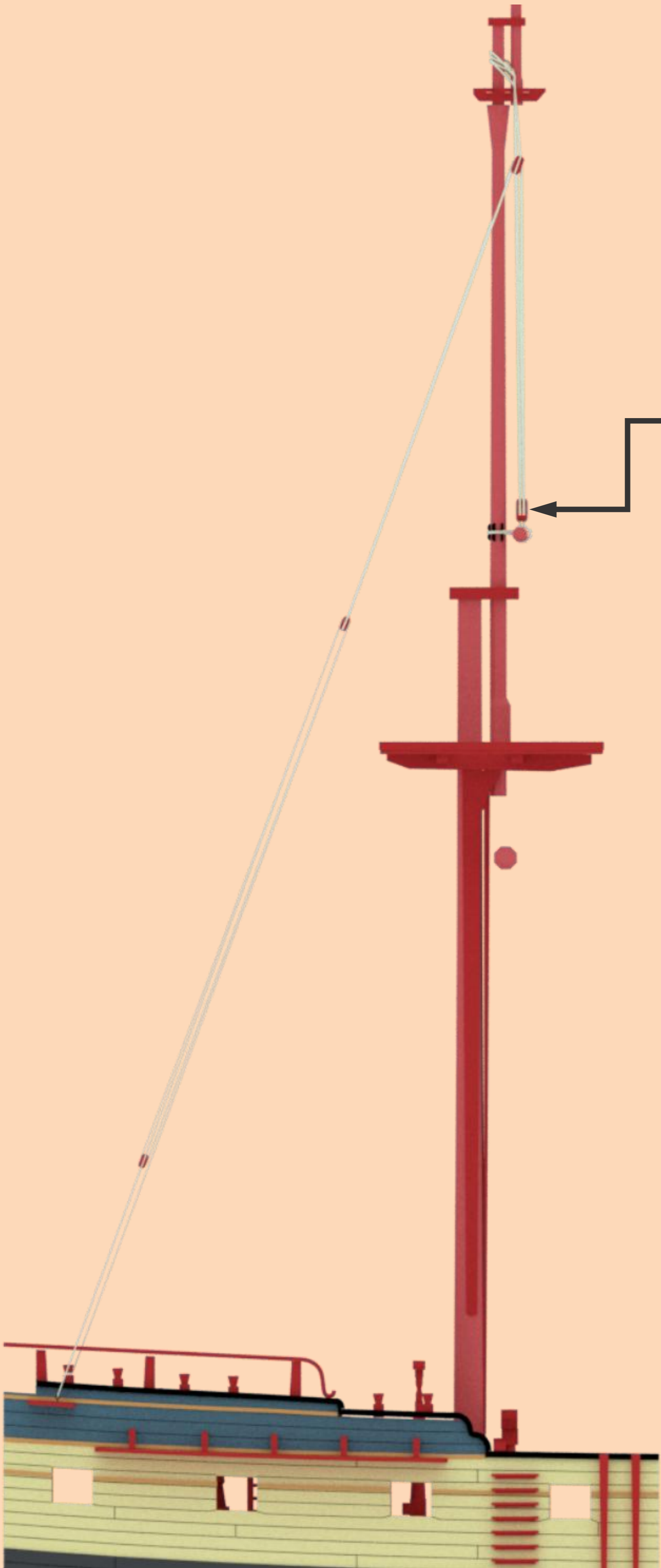
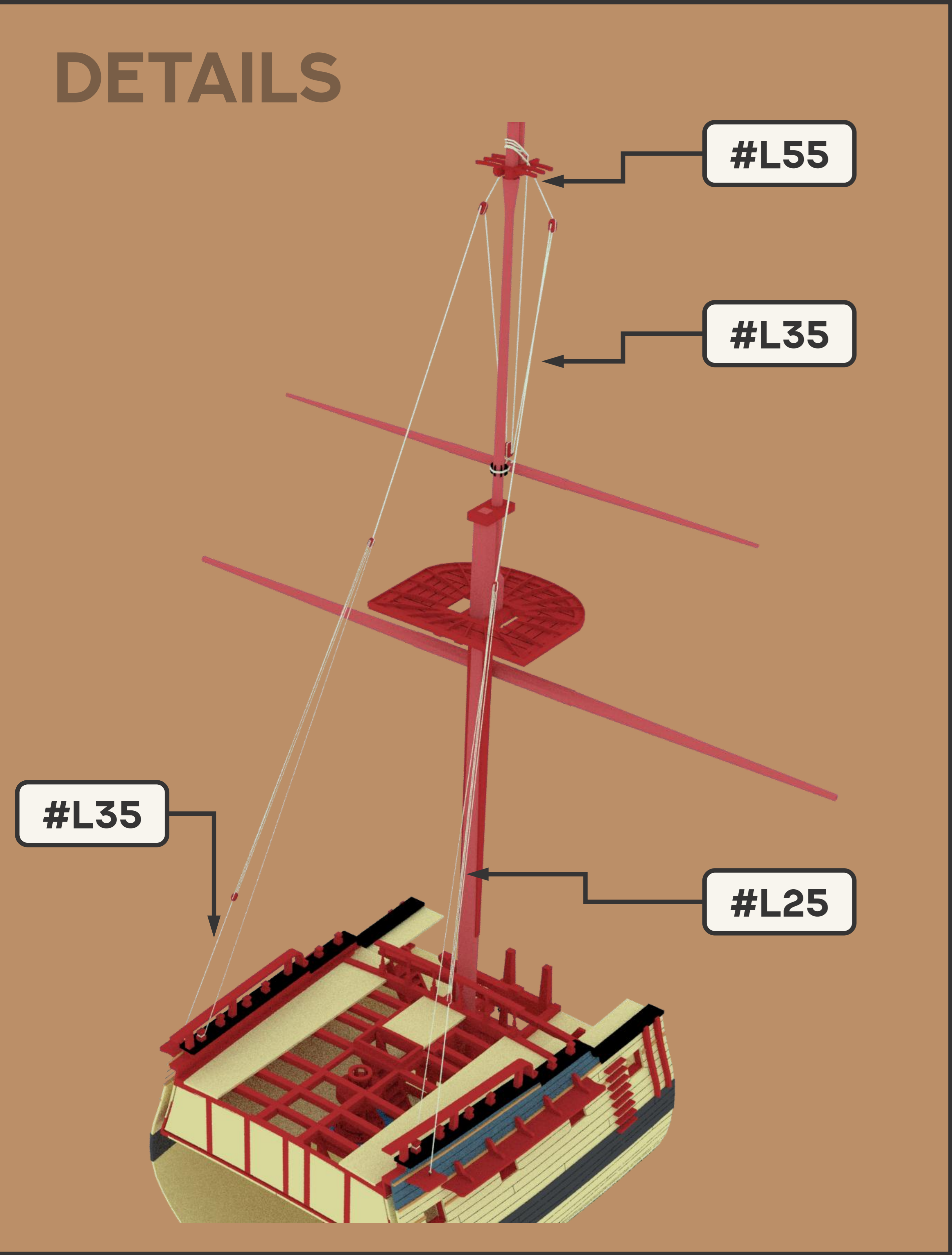

# 28. MAIN TOPSAIL YARD LIFT

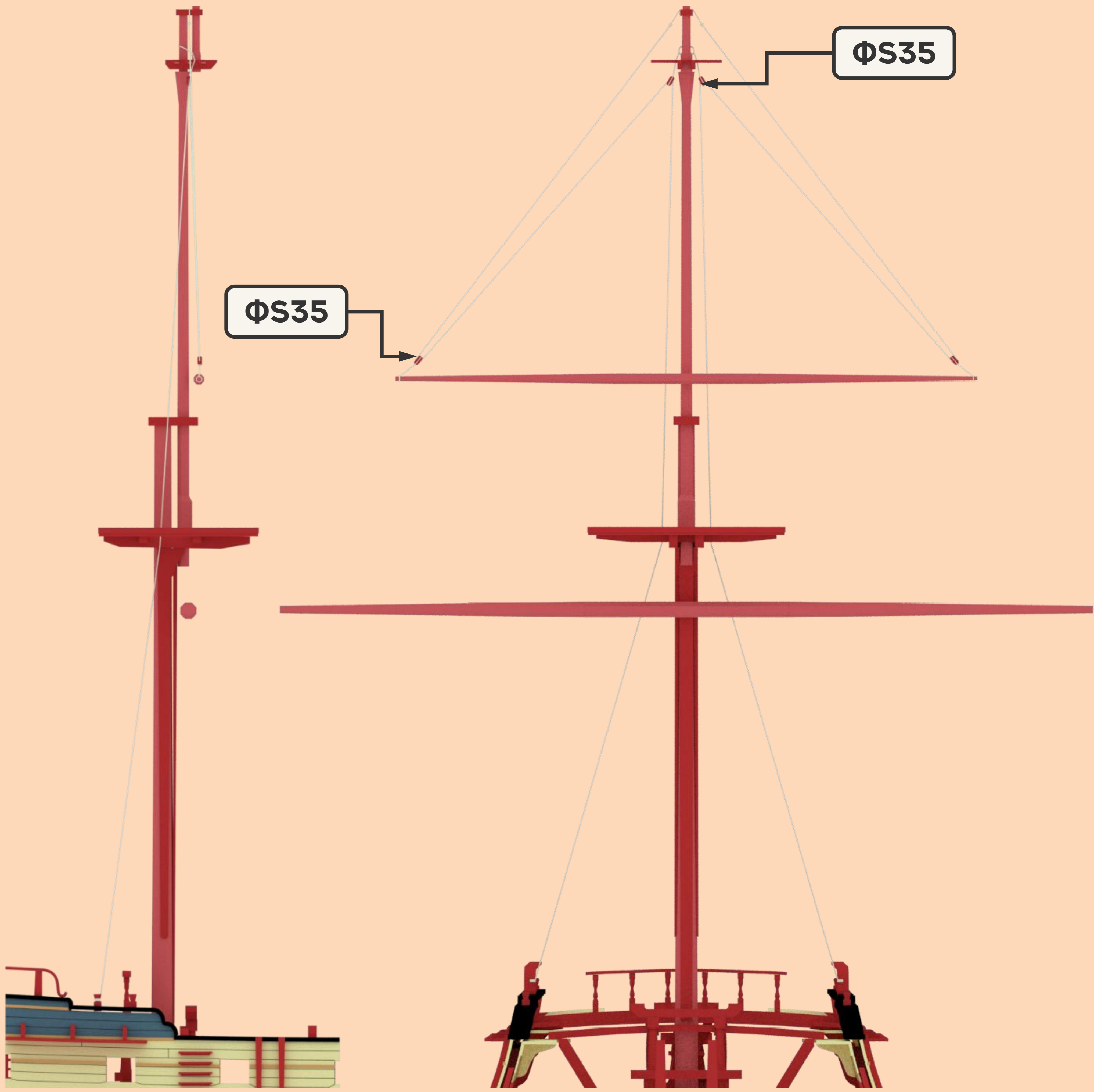
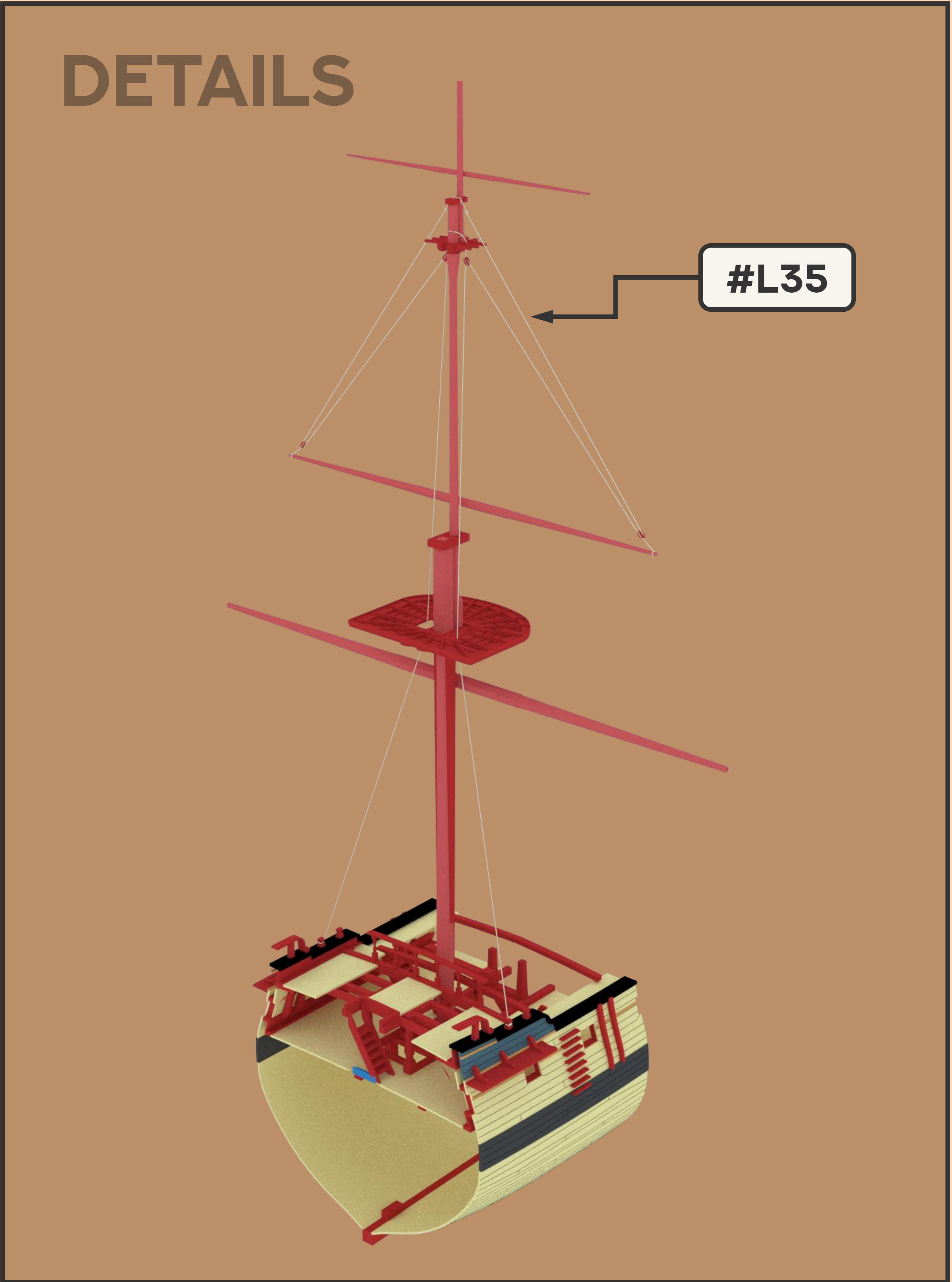



# 29. MAIN TOPGALLANT YARD HALLIARD

## DETAILS

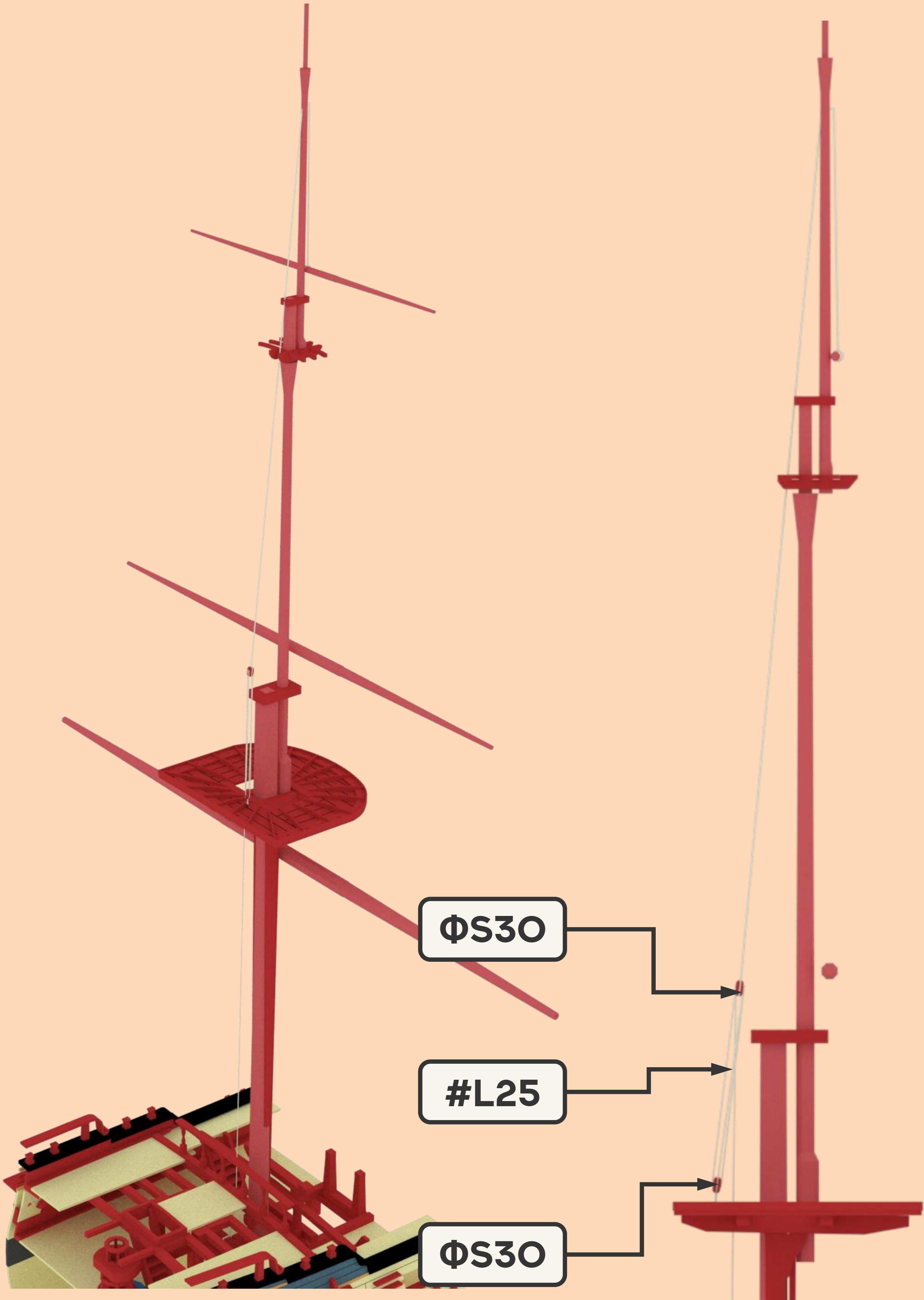
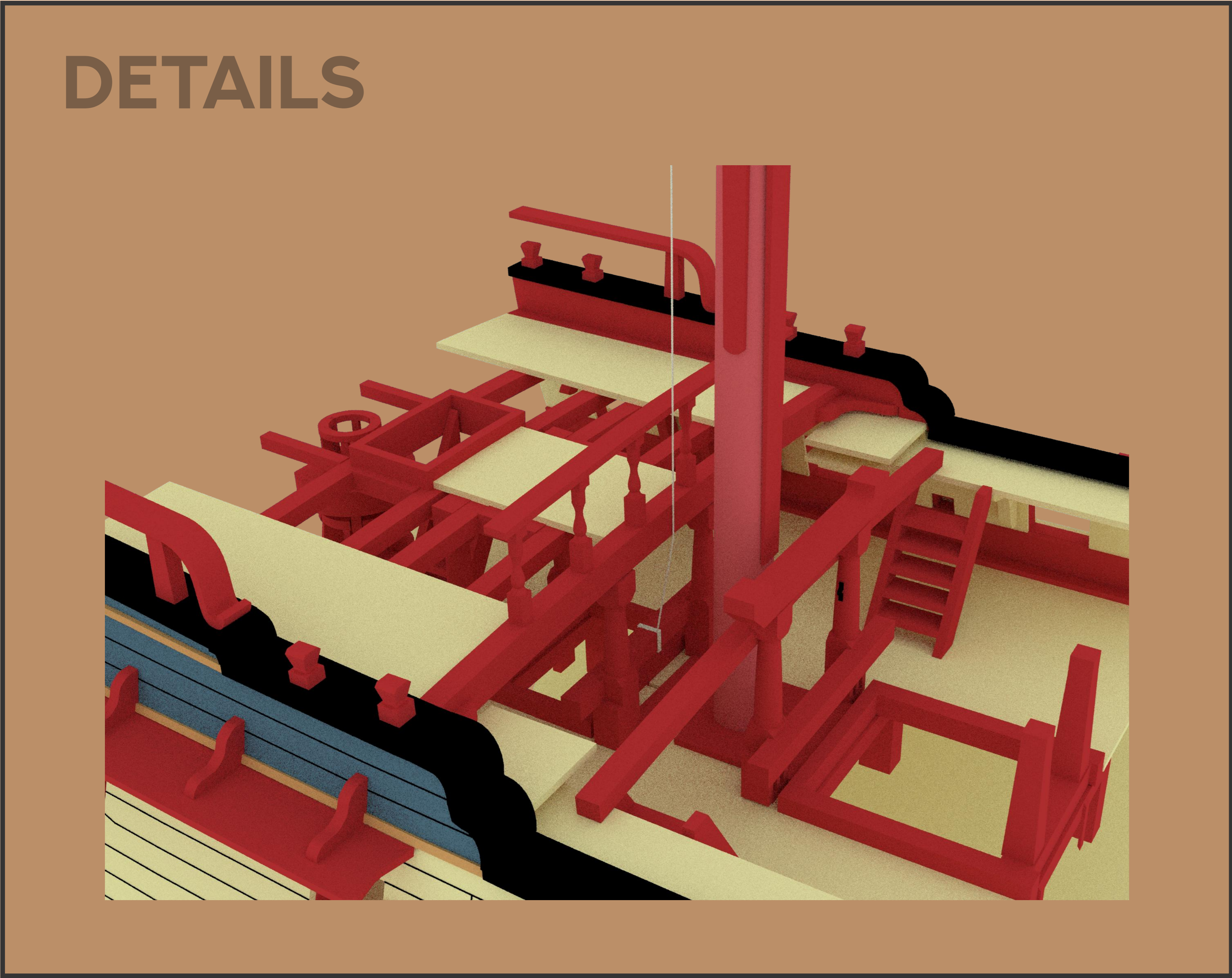

# 30. MAIN TOPGALLANT YARD LIFT

## DETAILS

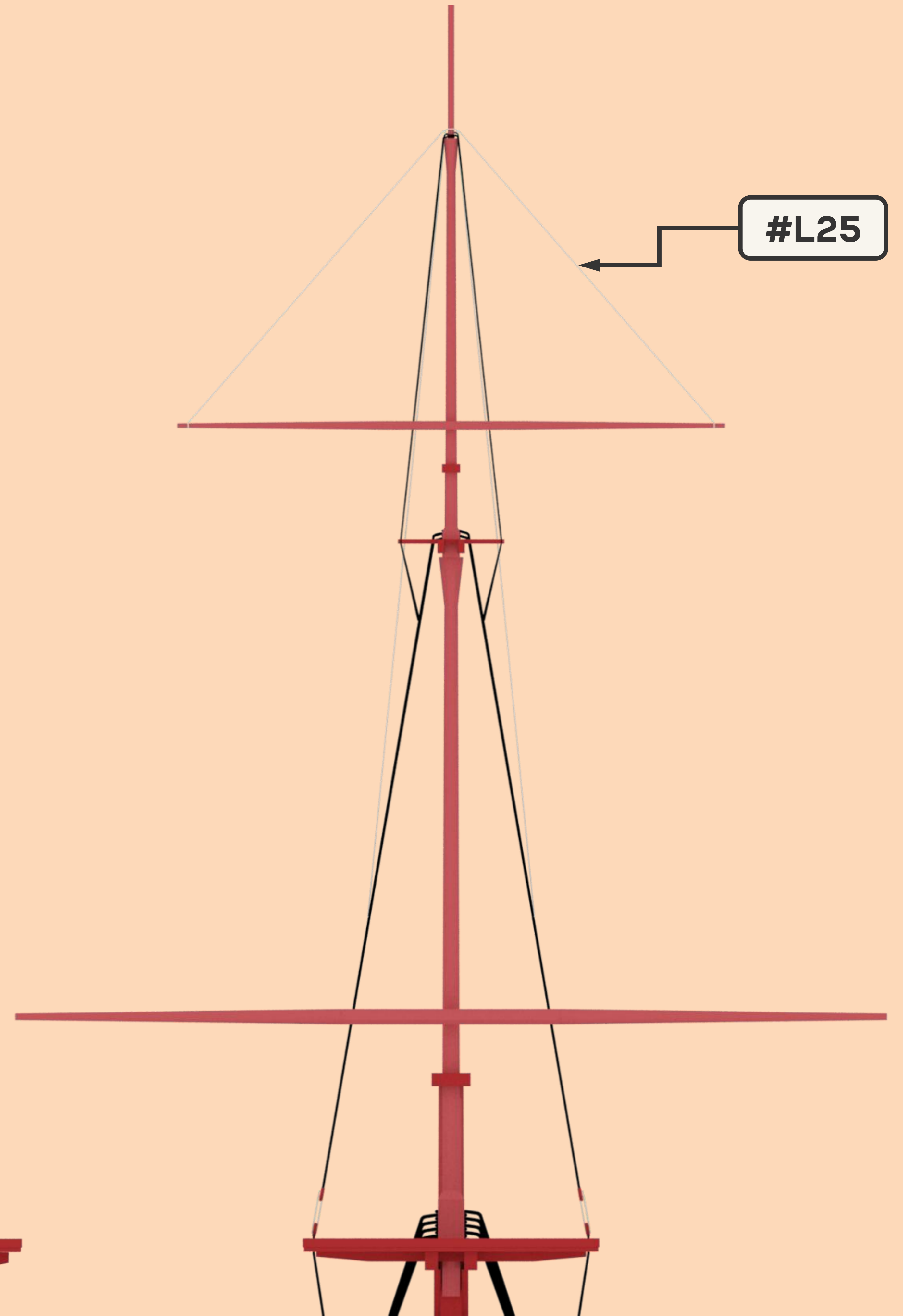
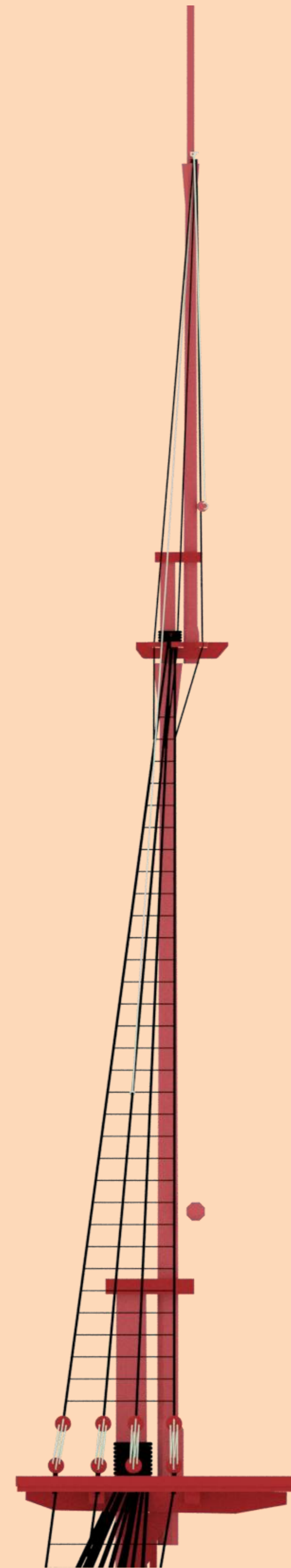
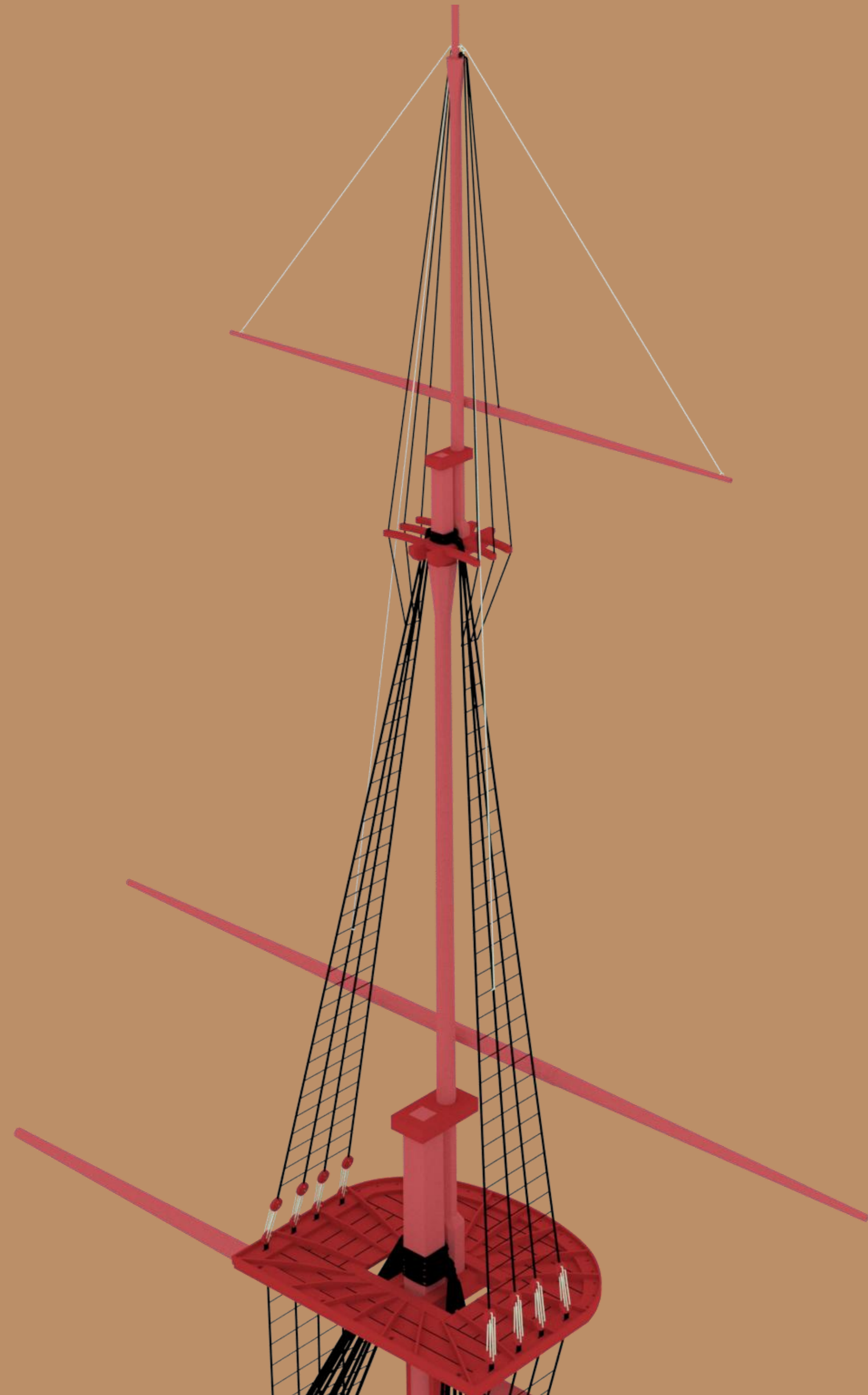

# 31. CROSS JACK SLING

## DETAILS

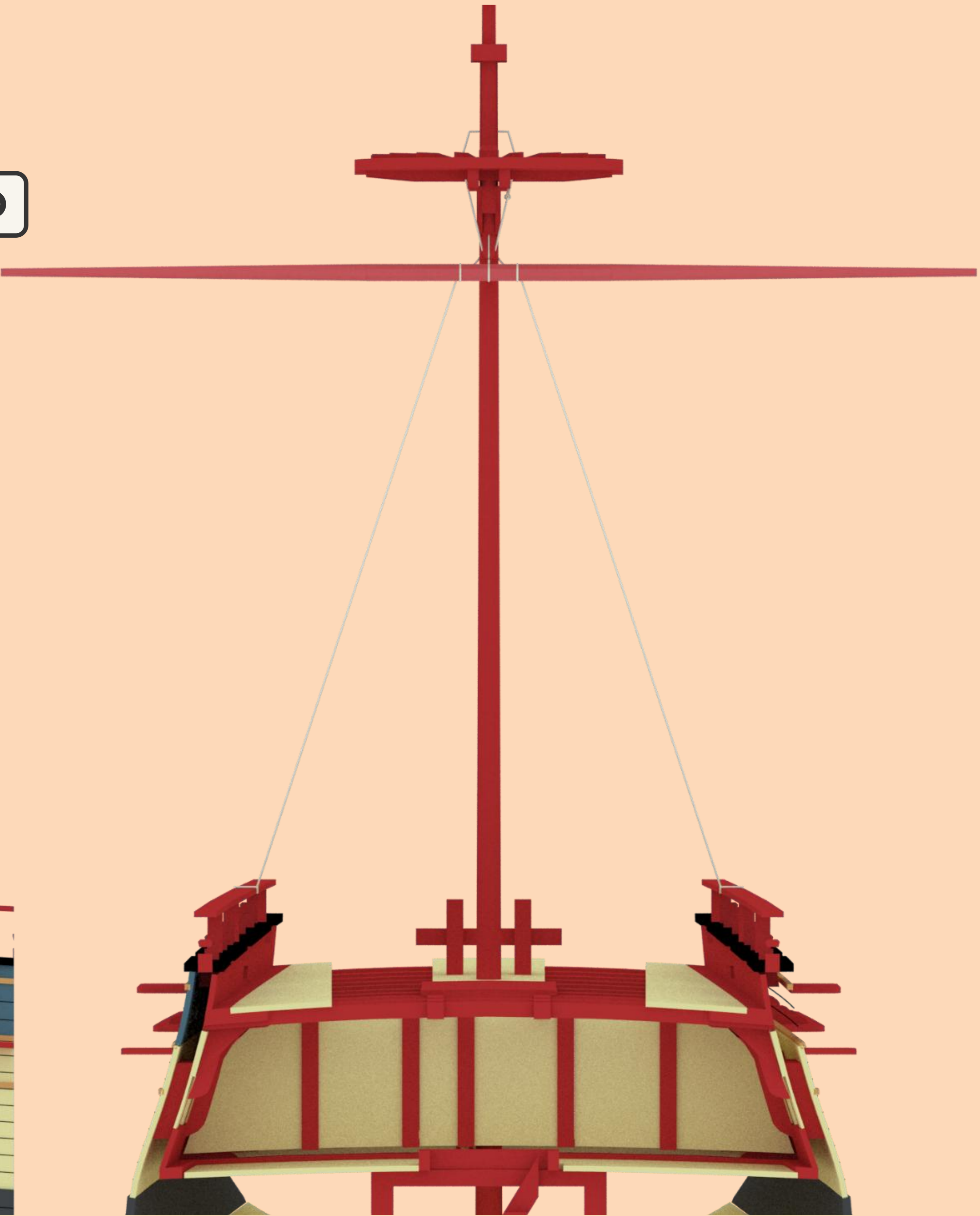
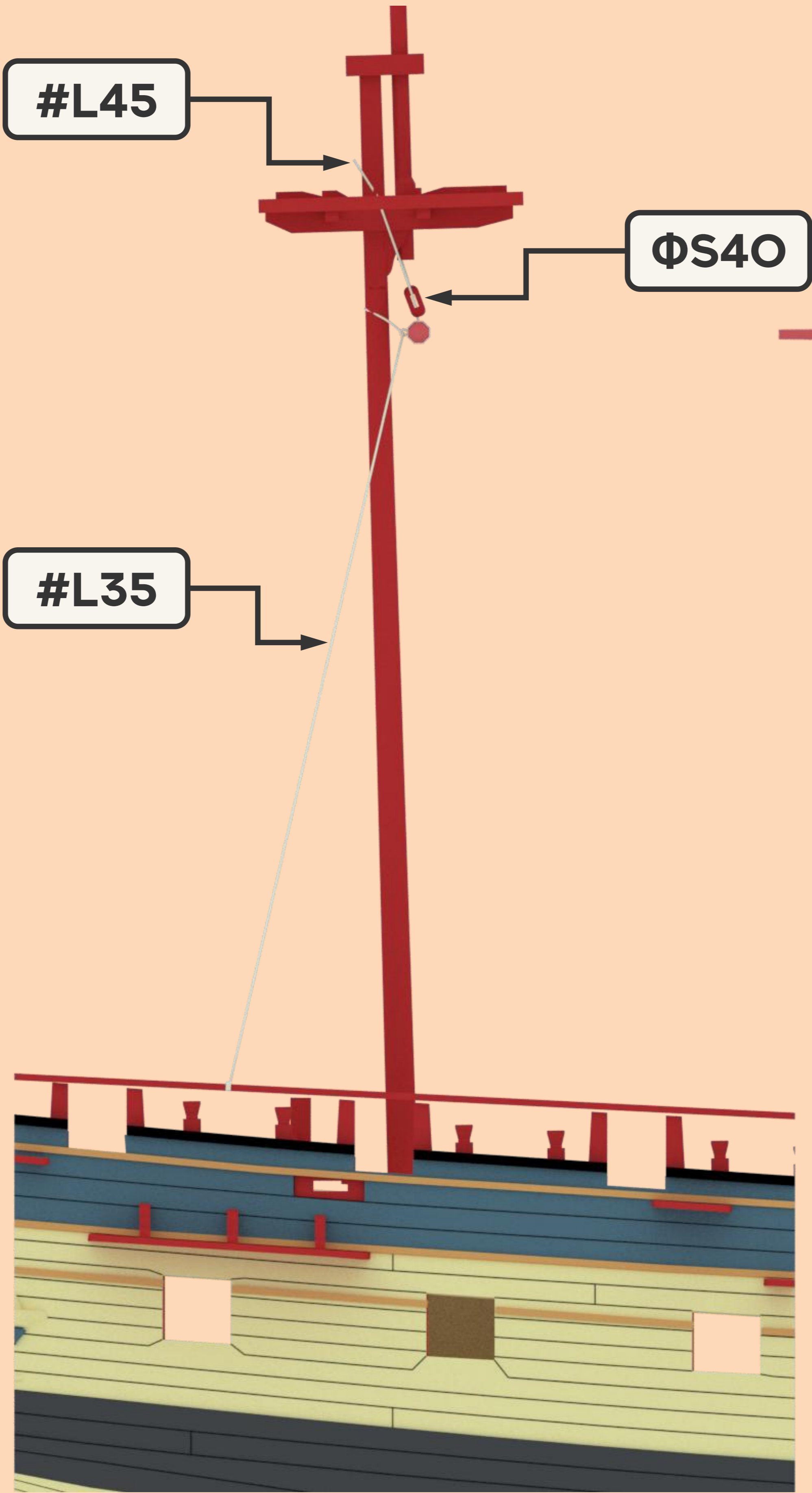

# 31. CROSS JACK LIFT

## DETAILS

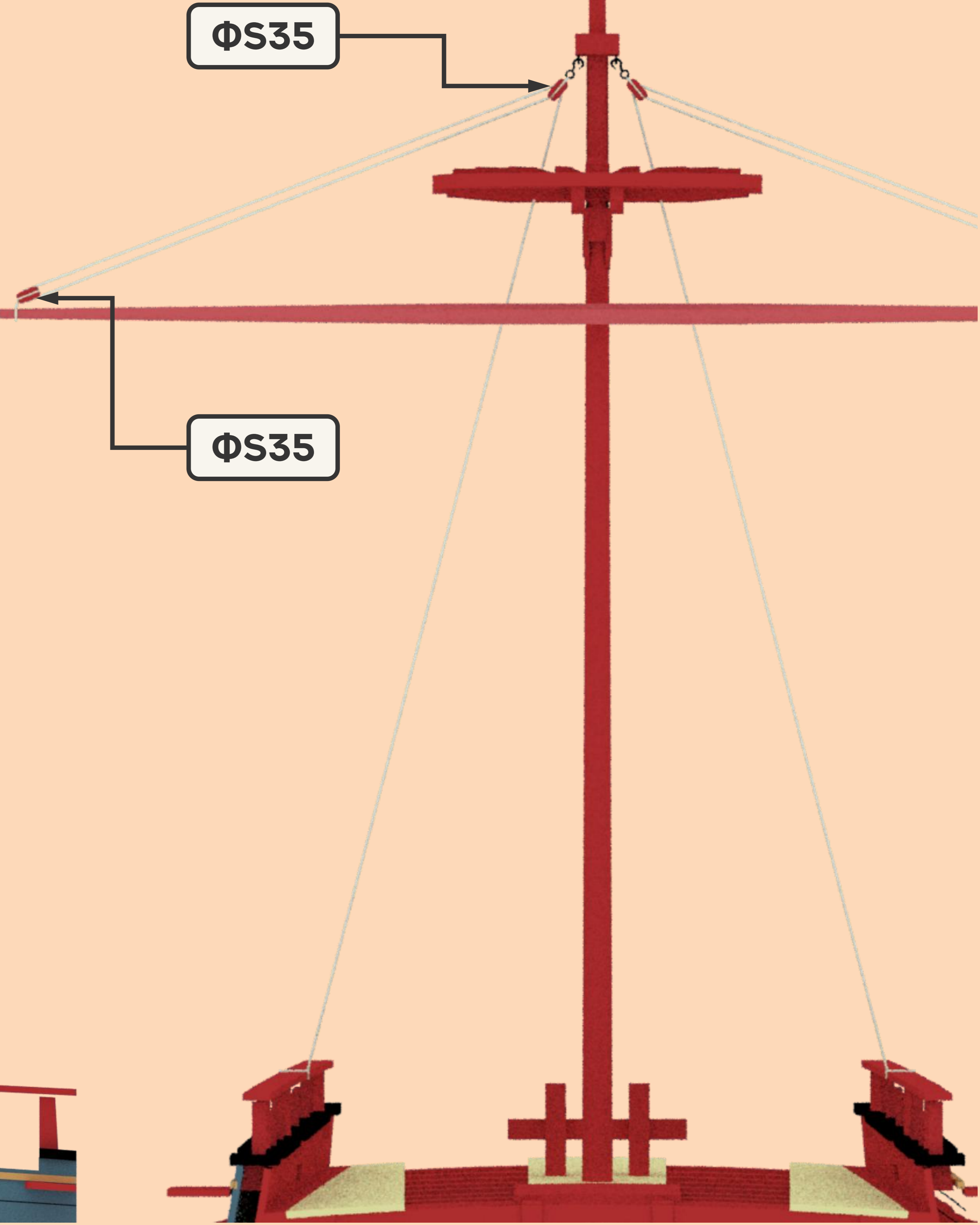
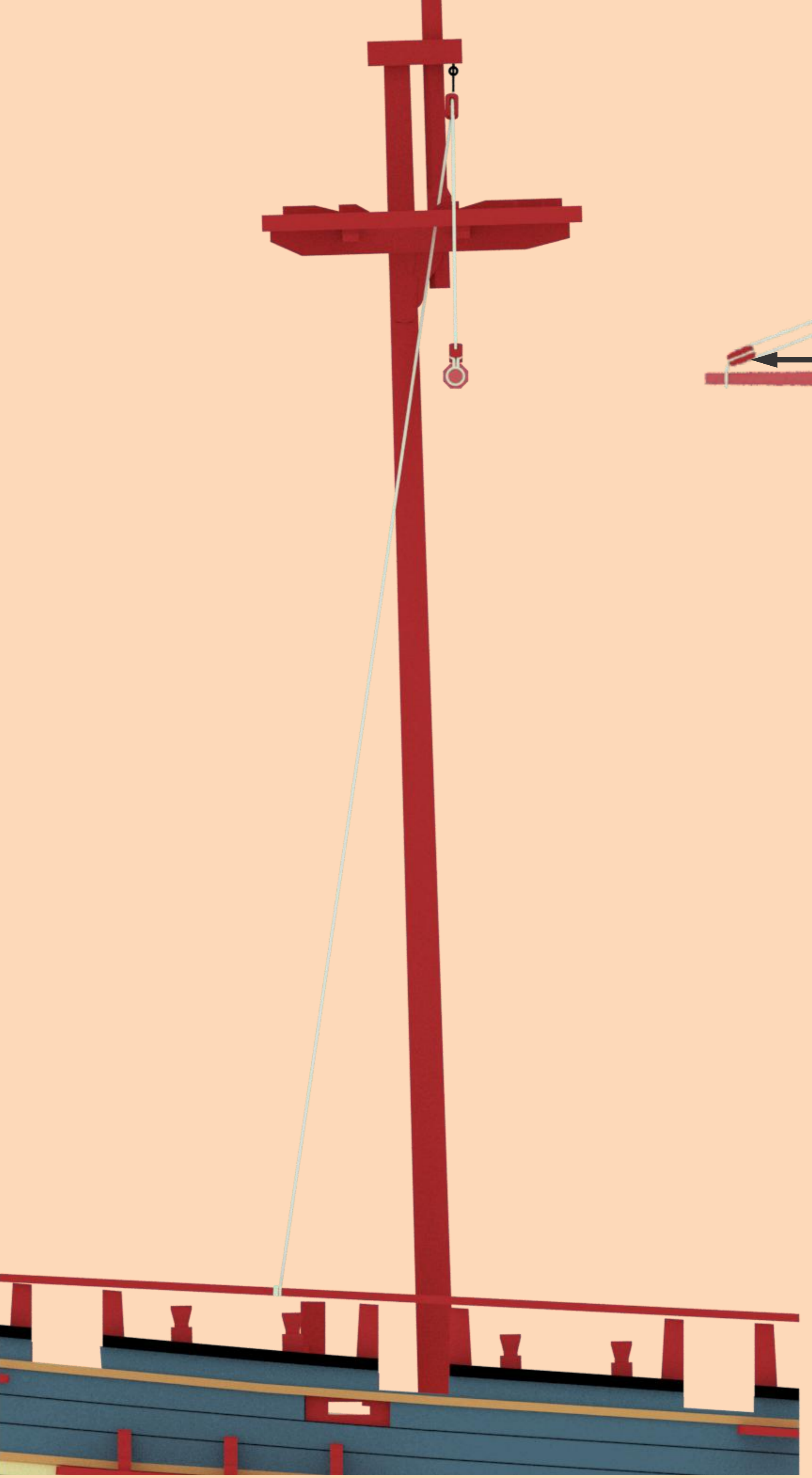
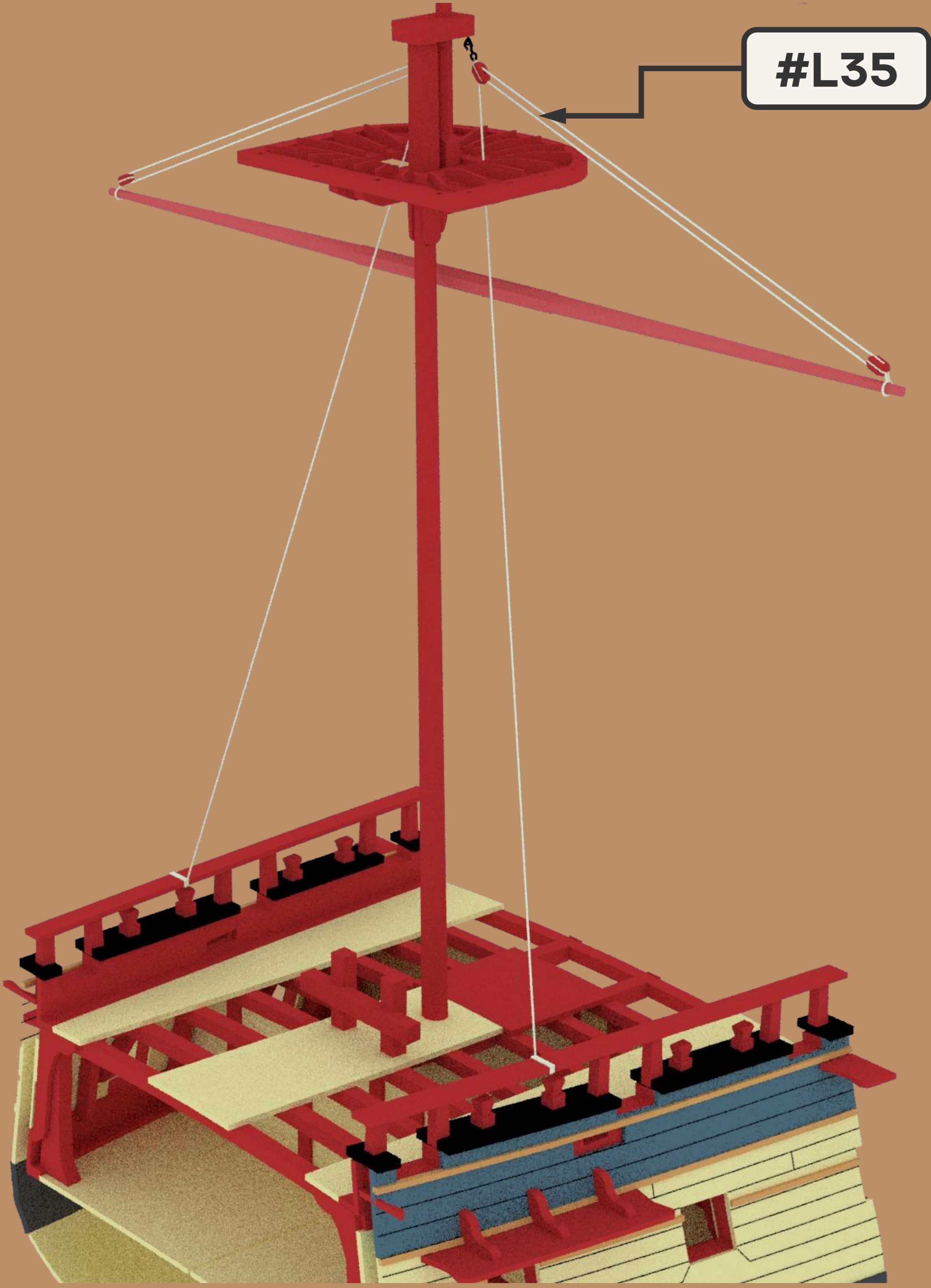

# 32. MIZZEN TOPSAIL YARD HALLIARD

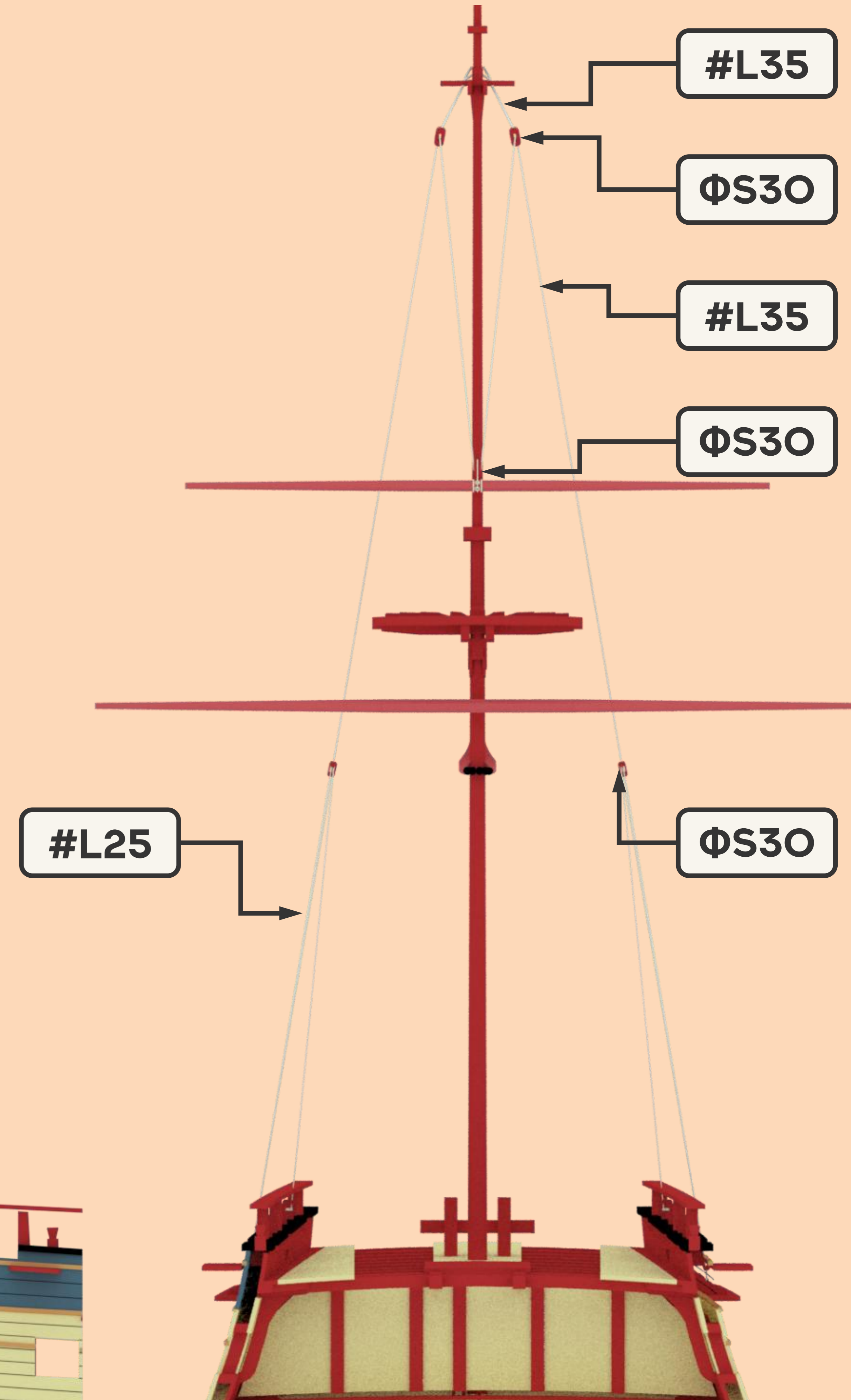
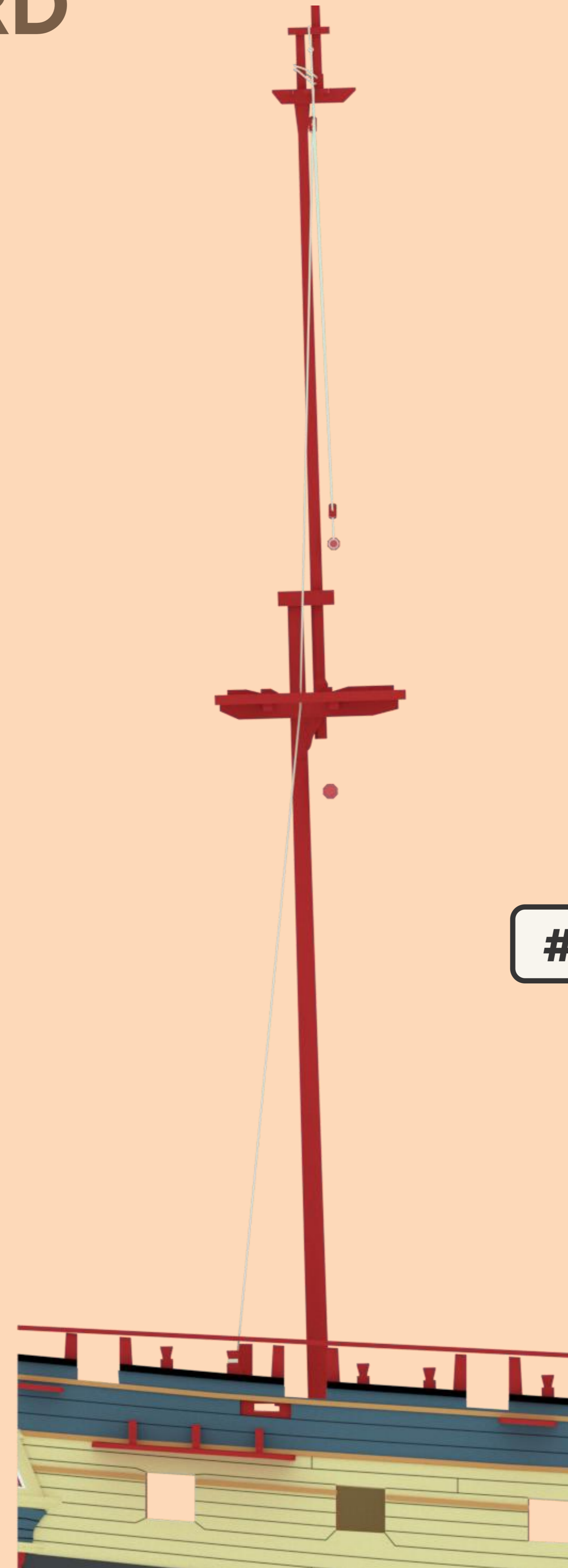
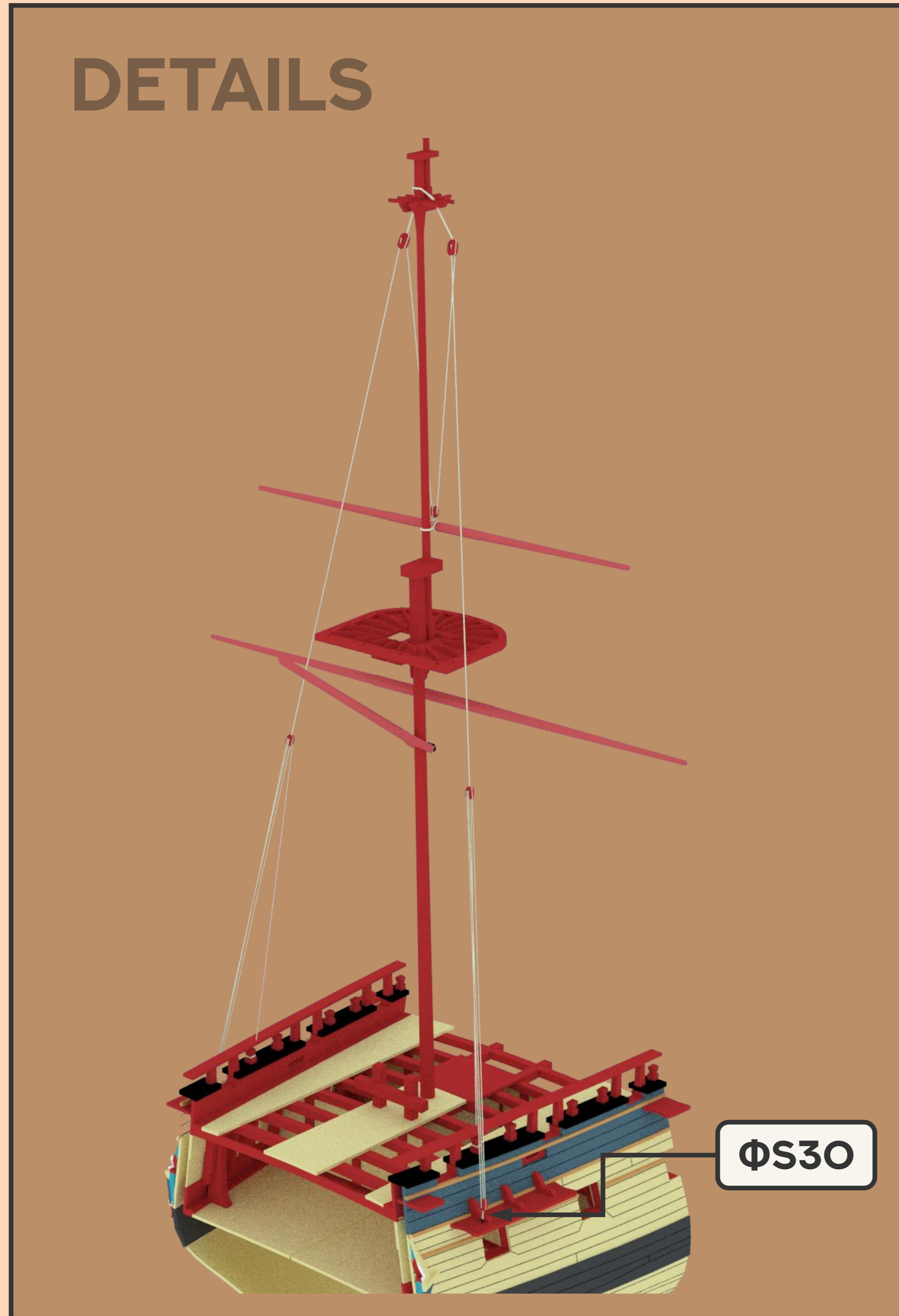

# 33. MIZZEN TOPSAIL YARD LIFT

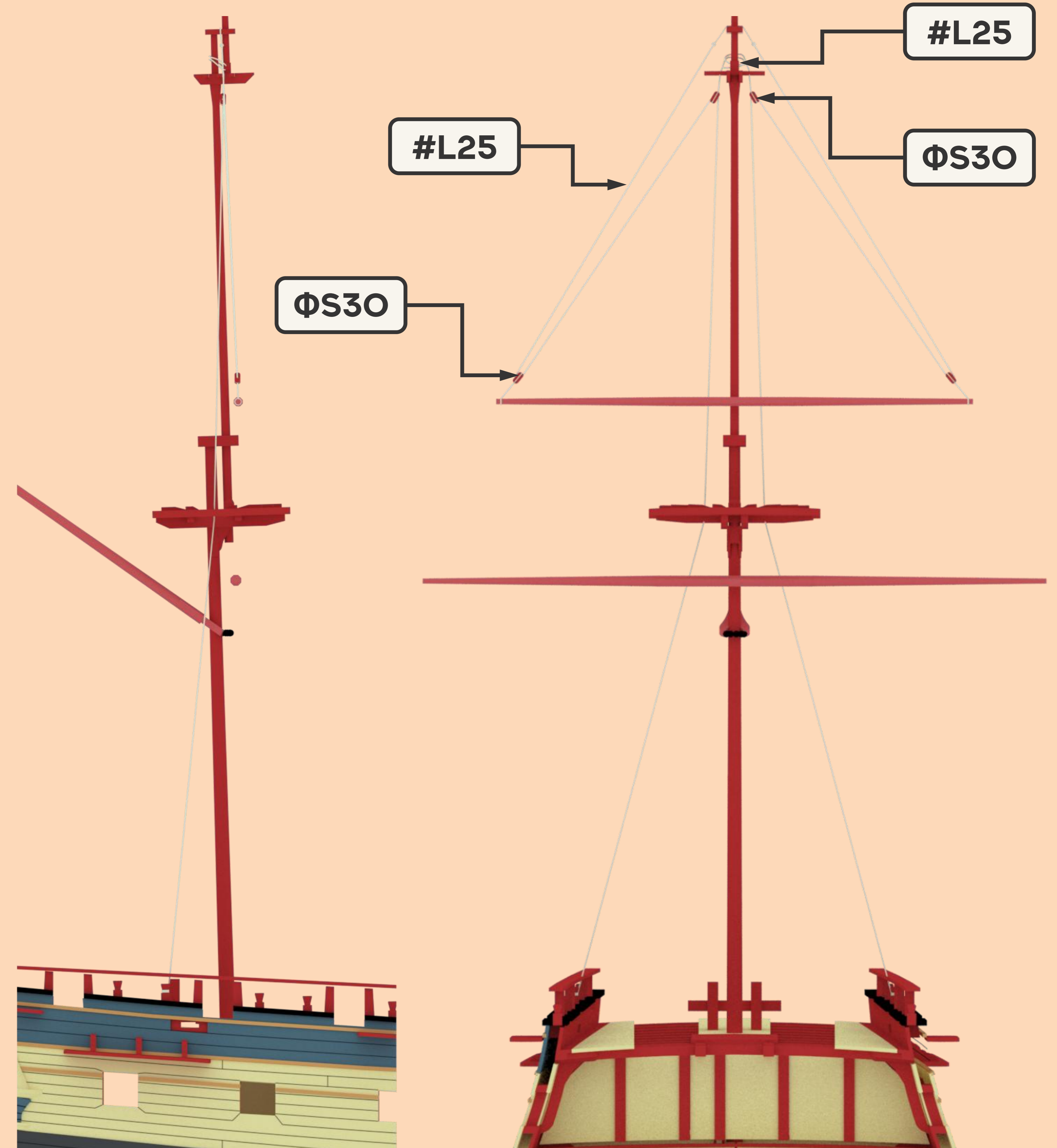
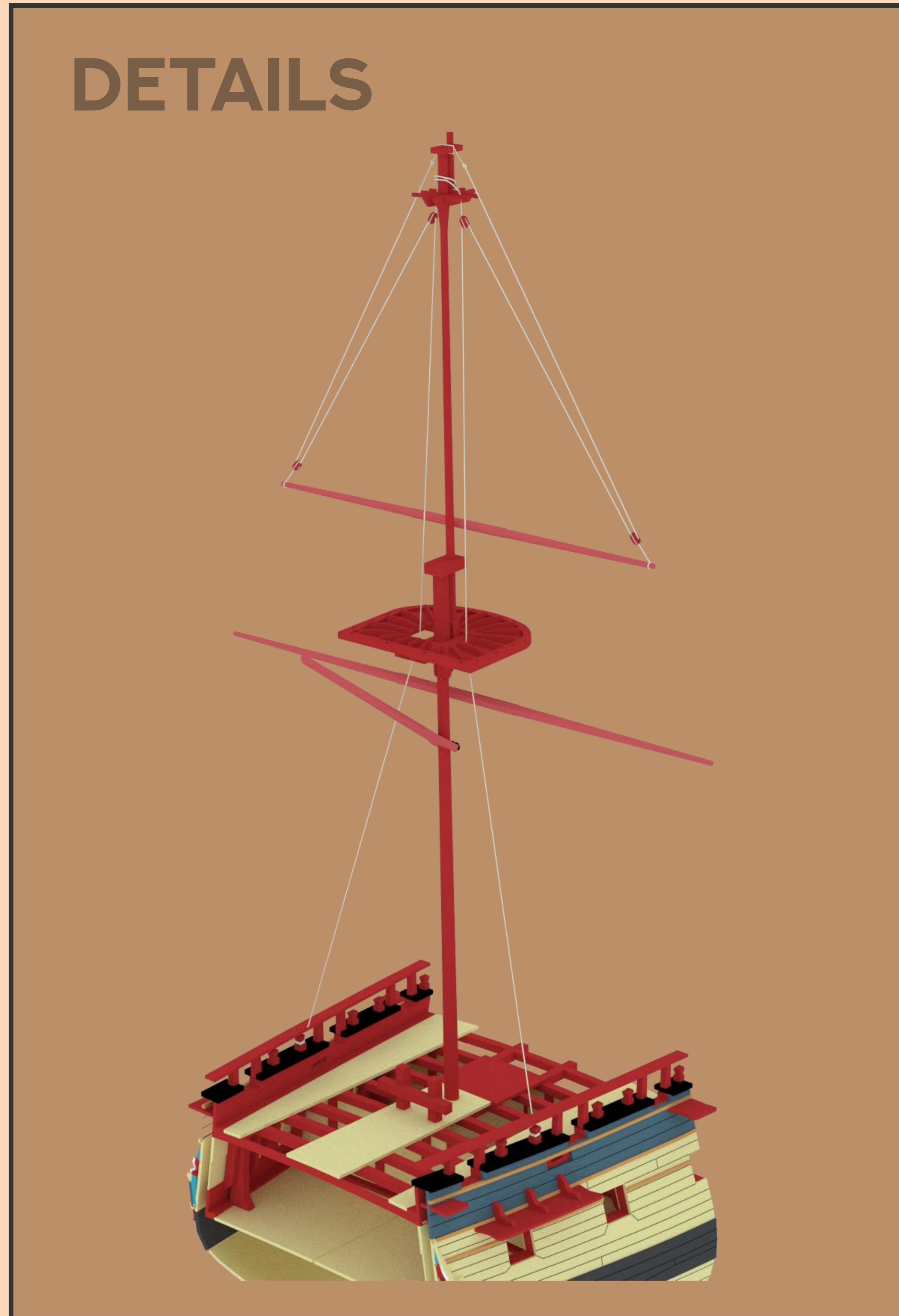

# 34. MIZZEN TOPGALLANT YARD HALLIARD

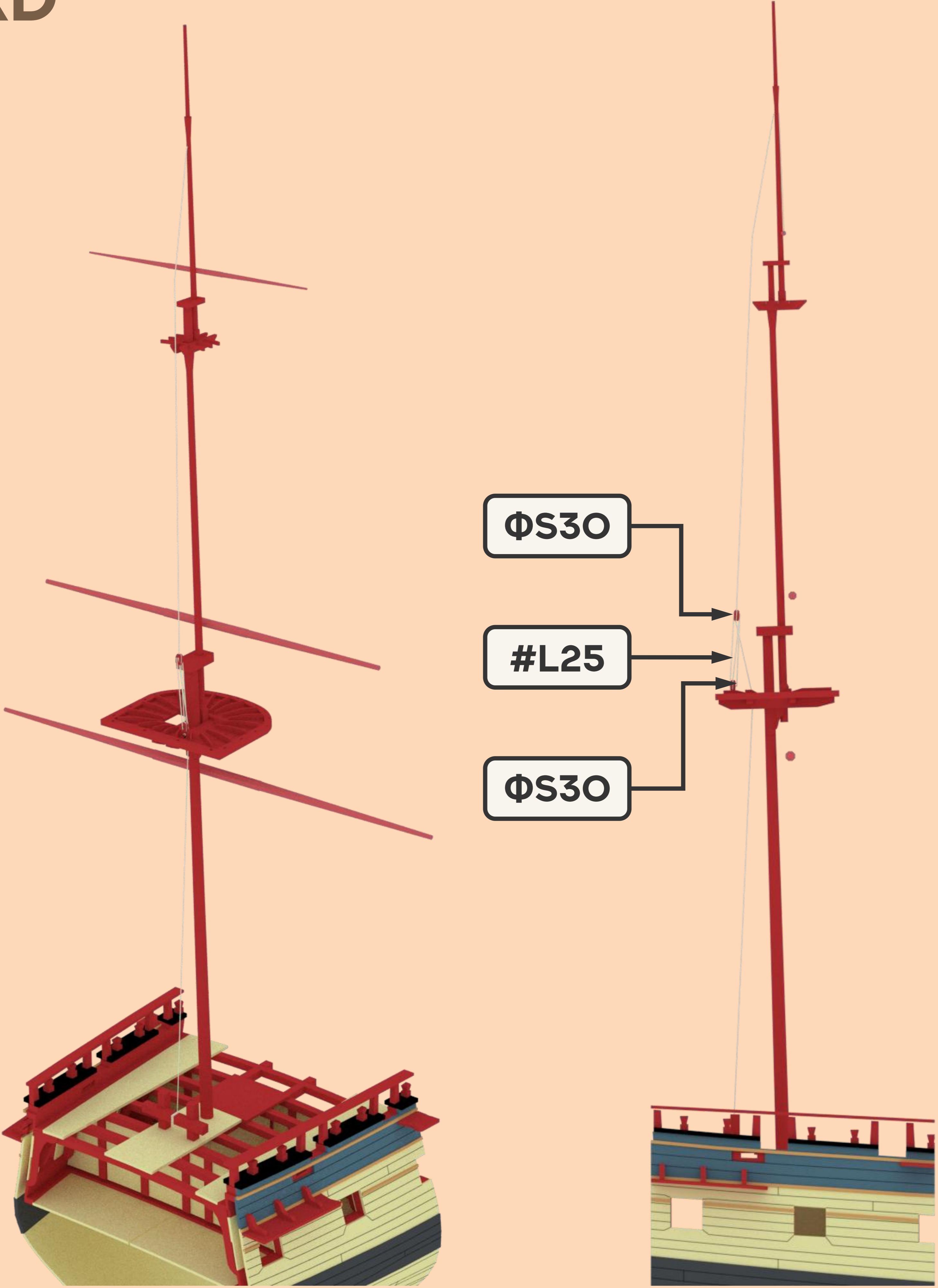
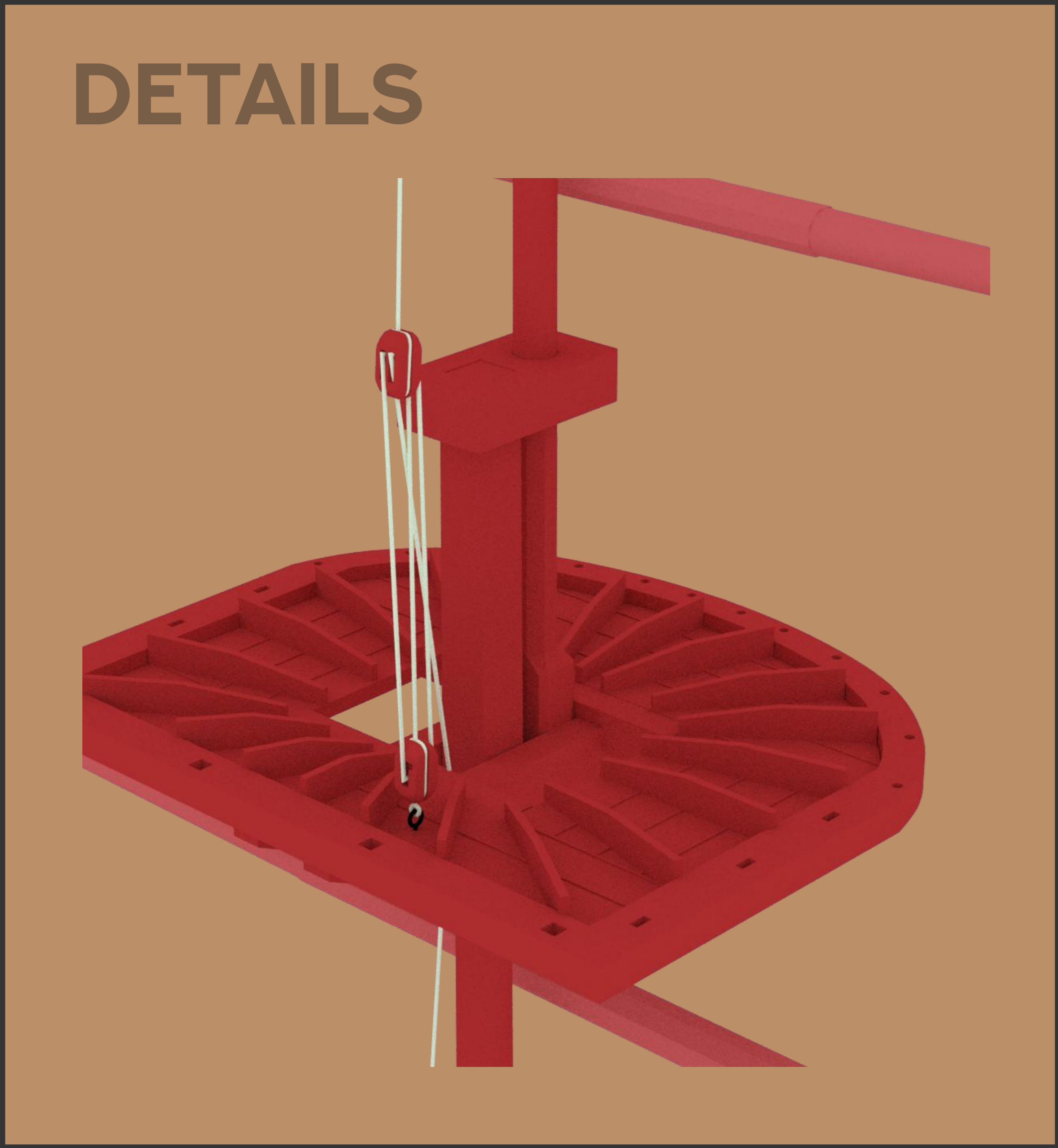

# 35. MIZZEN TOPGALLANT YARD LIFT

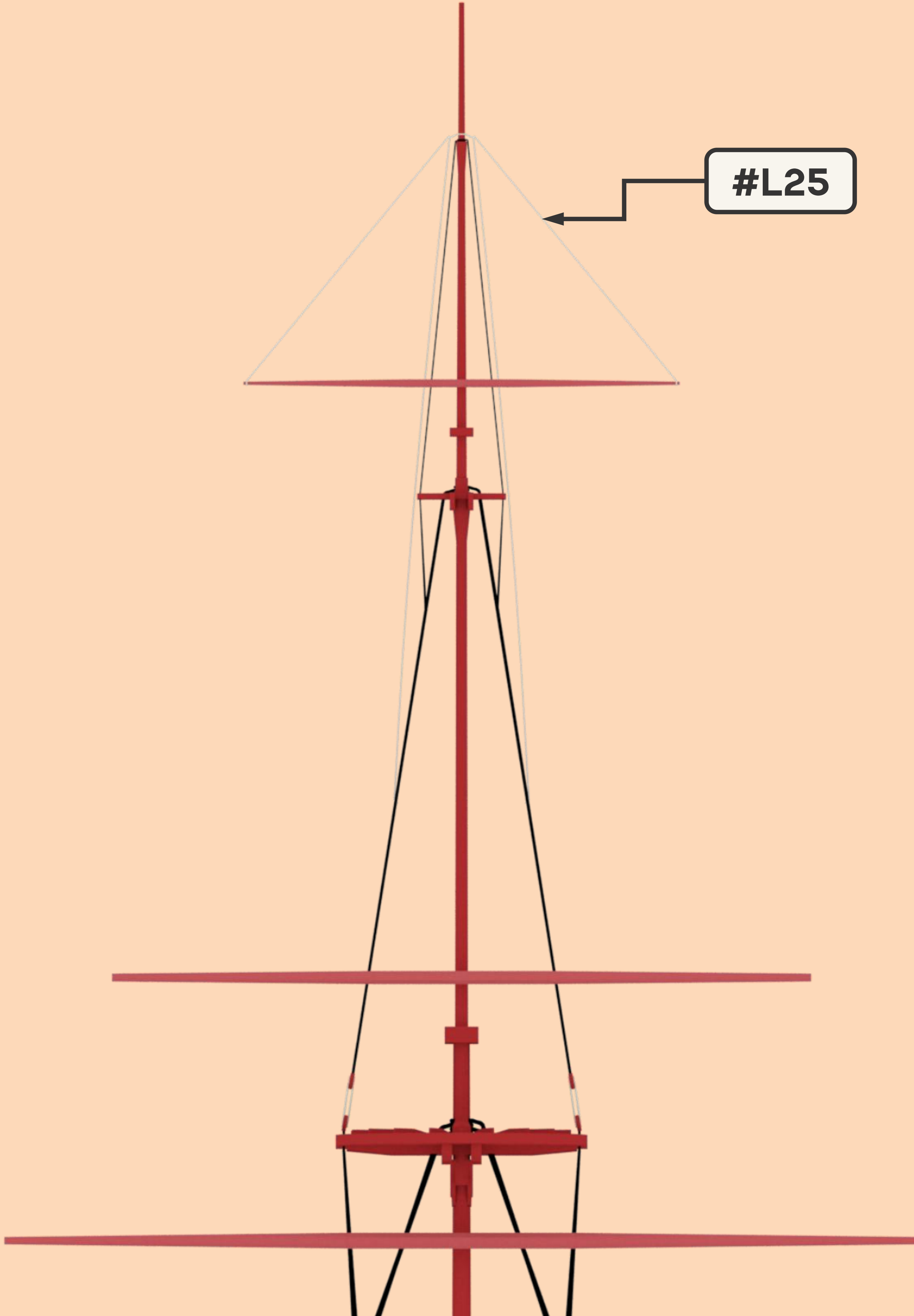
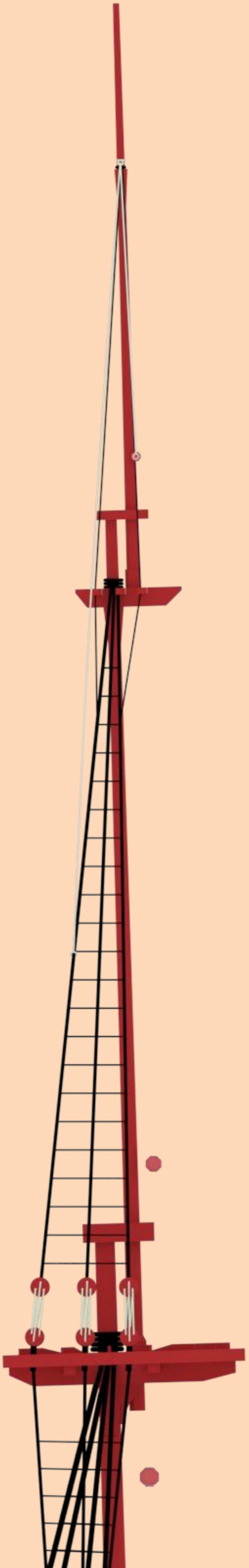
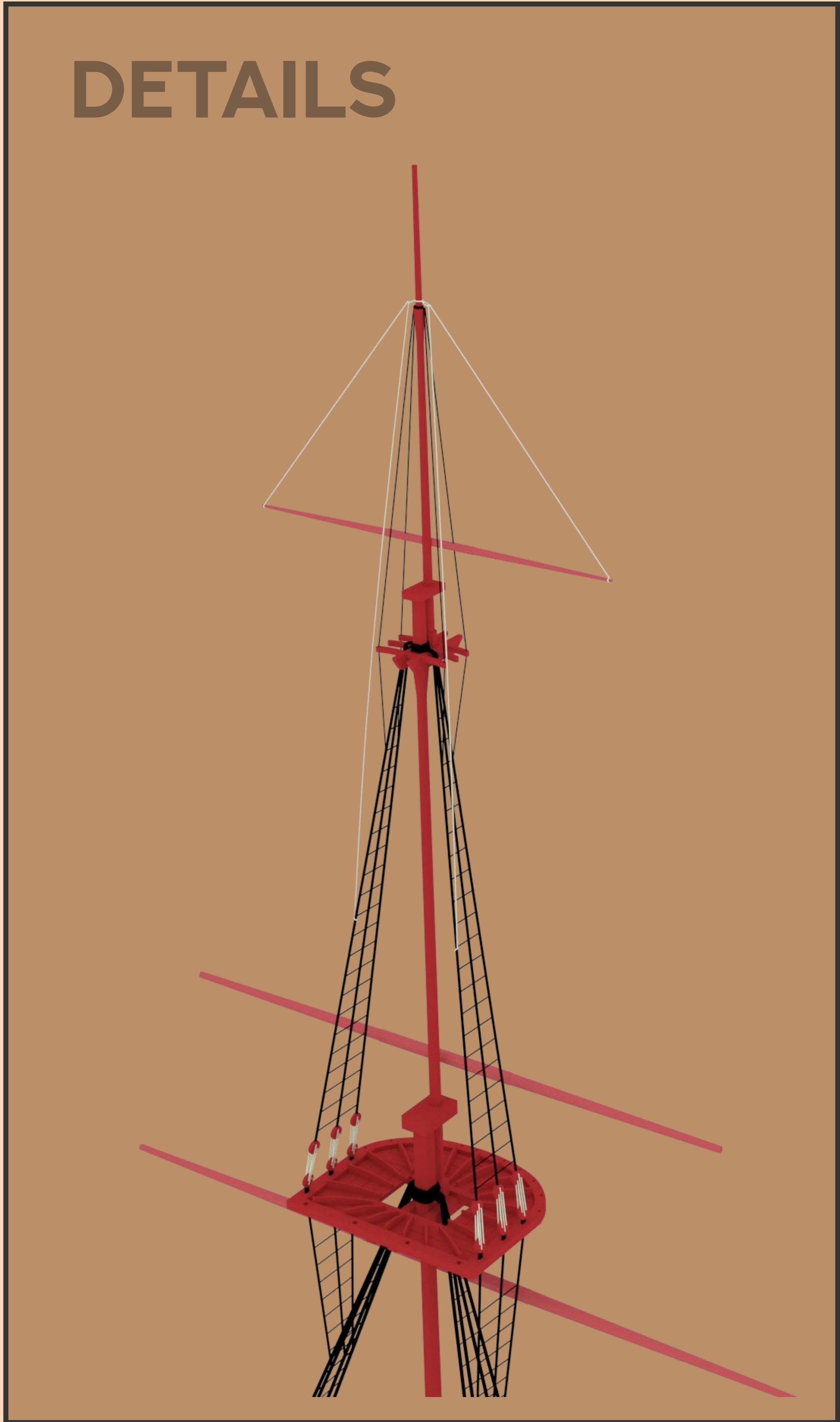



# 36. SPRITSAIL SLING & HALLIARD

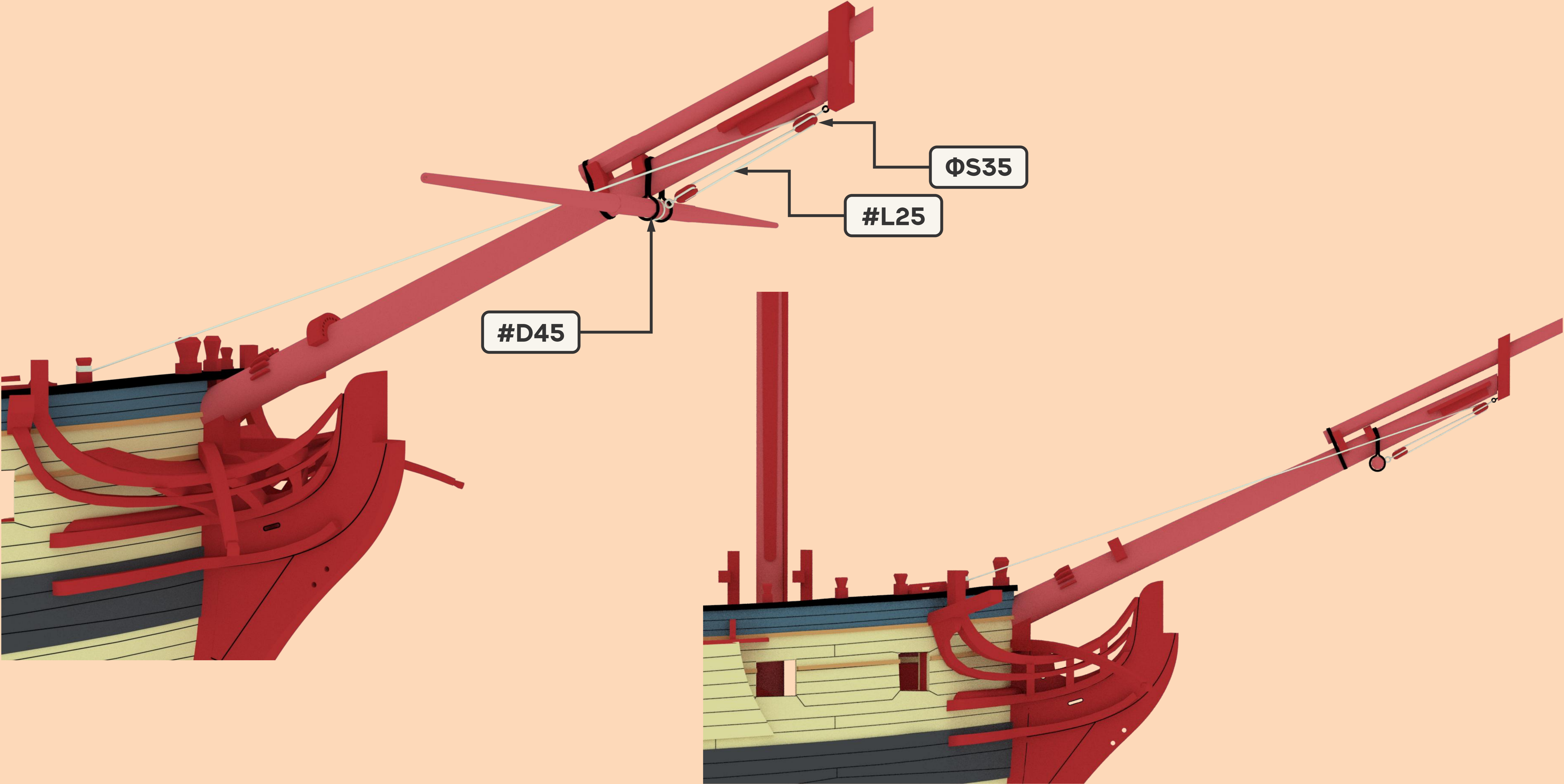

# 37. SPRITSAIL LIFT

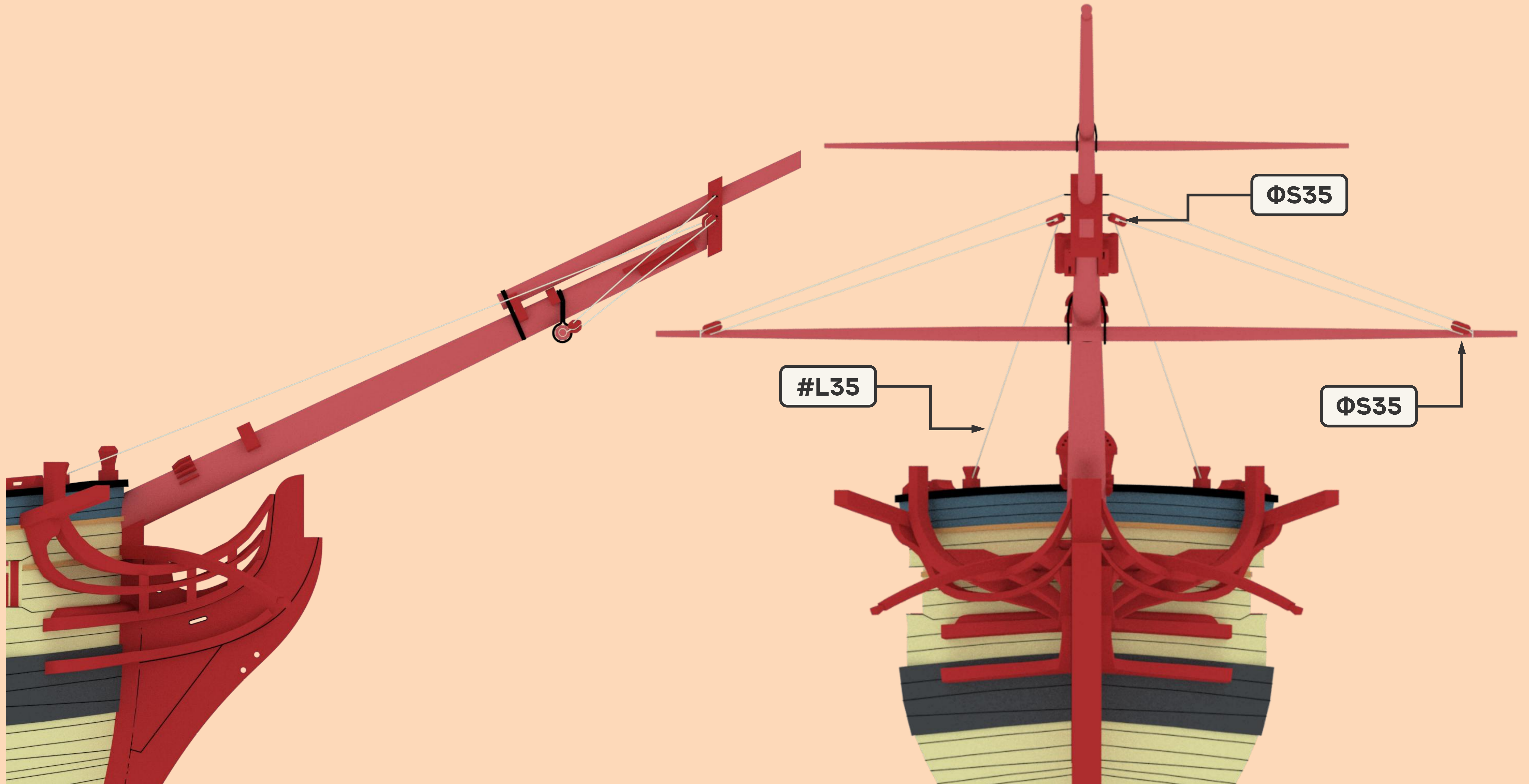

# 37. SPRITSAIL LIFT

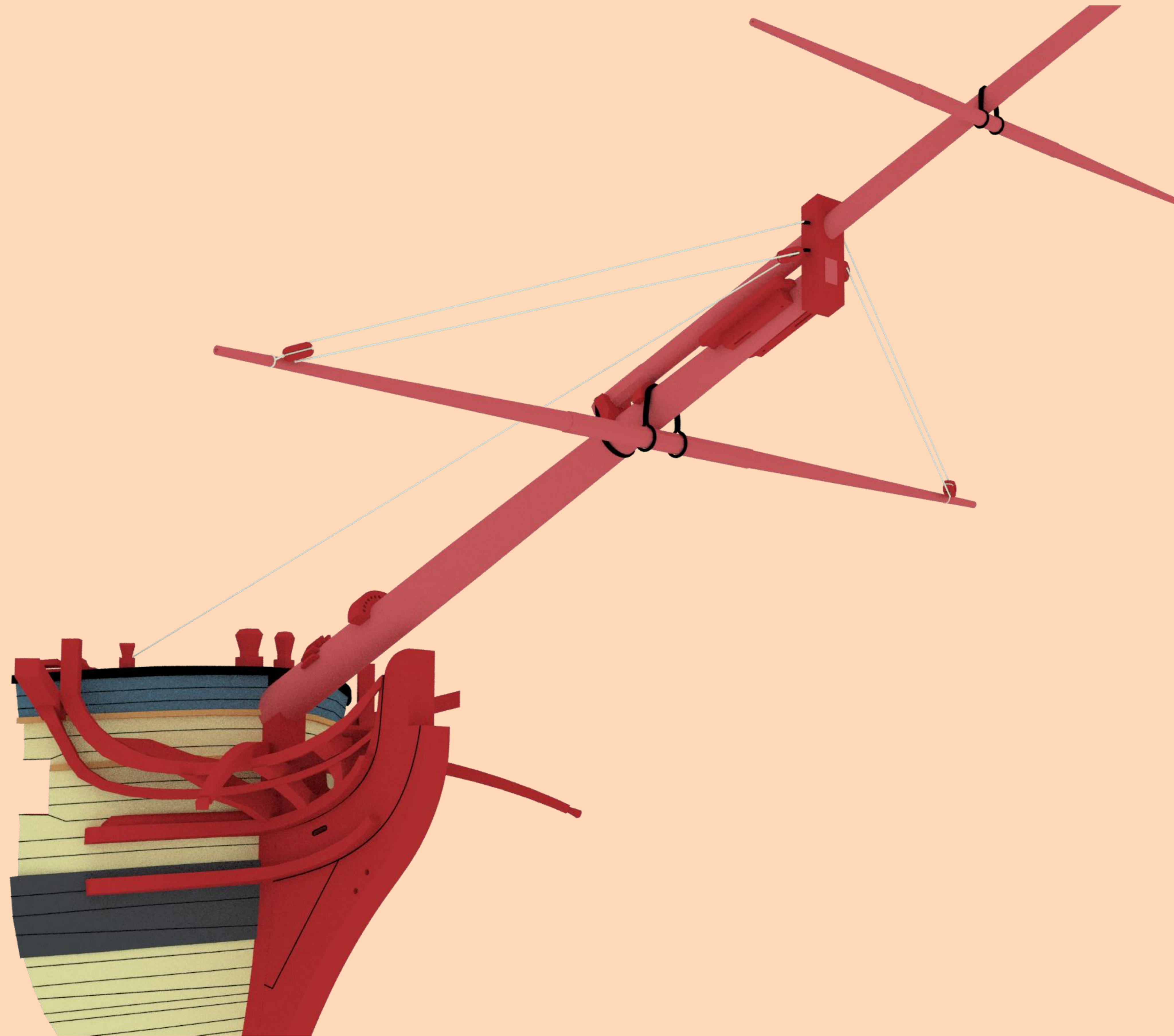

# 38. SPRITSAIL TOPSAIL SLING & HALLIARD

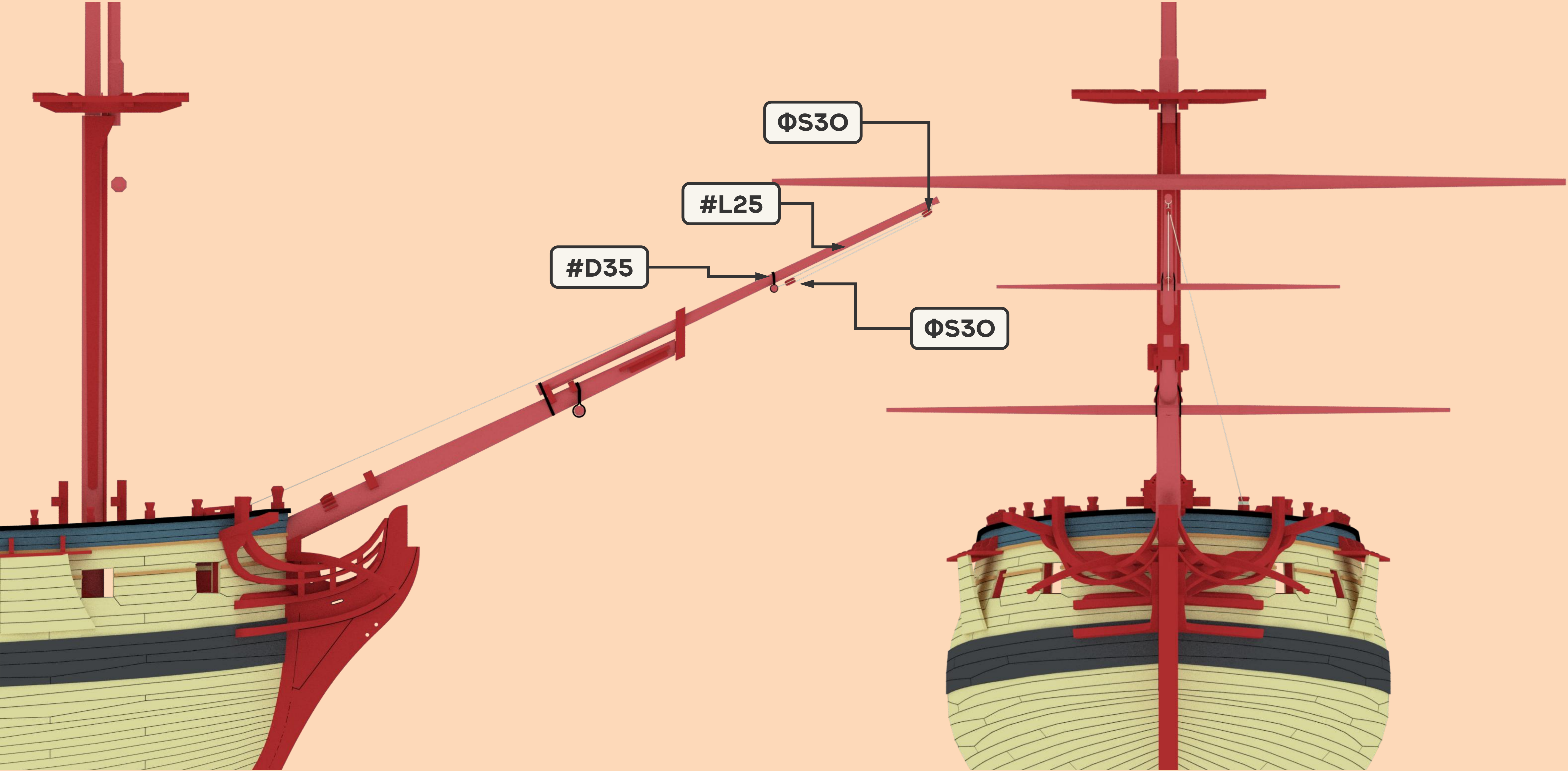

# 38. SPRITSAIL TOPSAIL SLING & HALLIARD

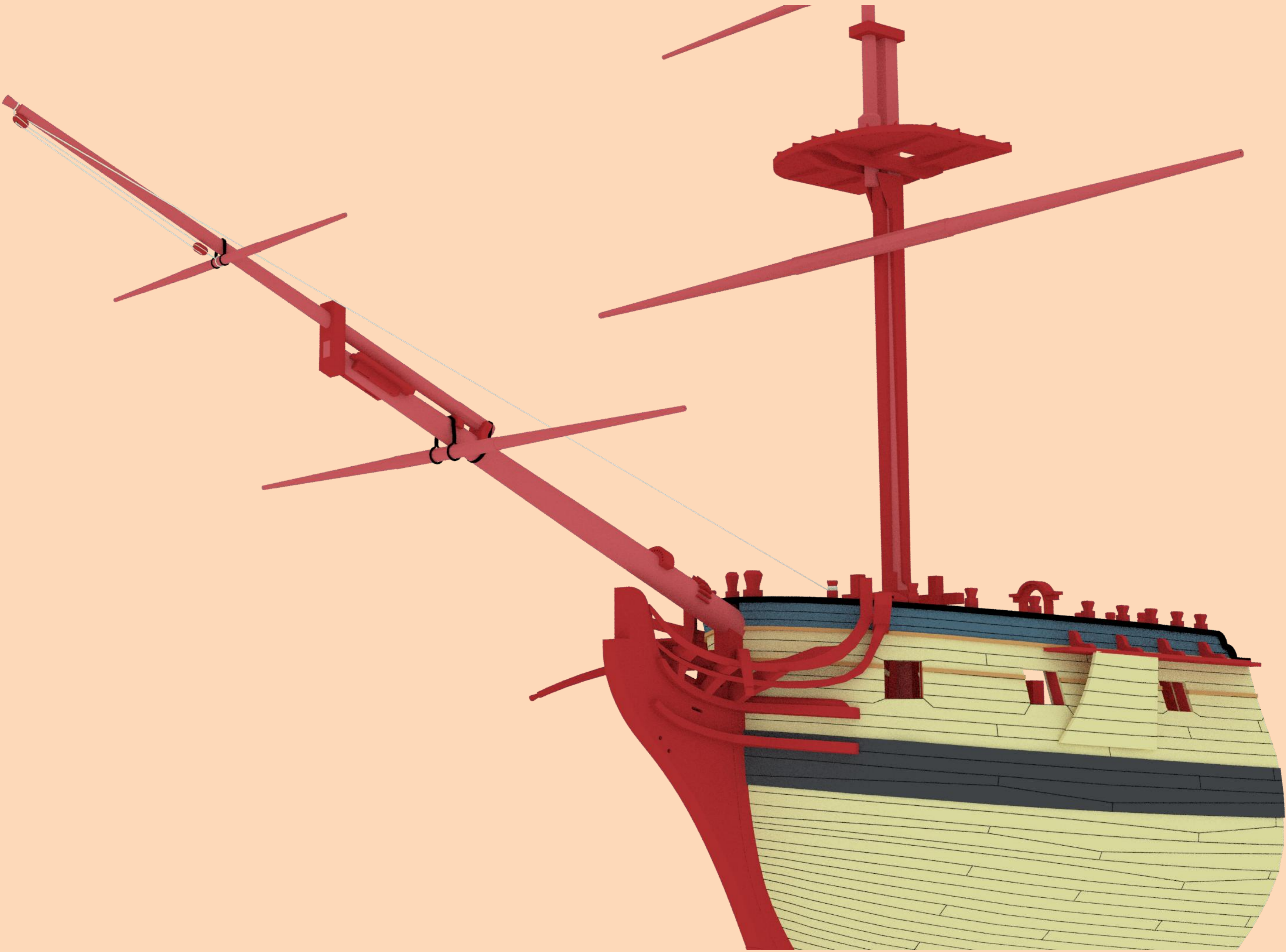

# 39. SPRITSAIL TOPSAIL LIFT

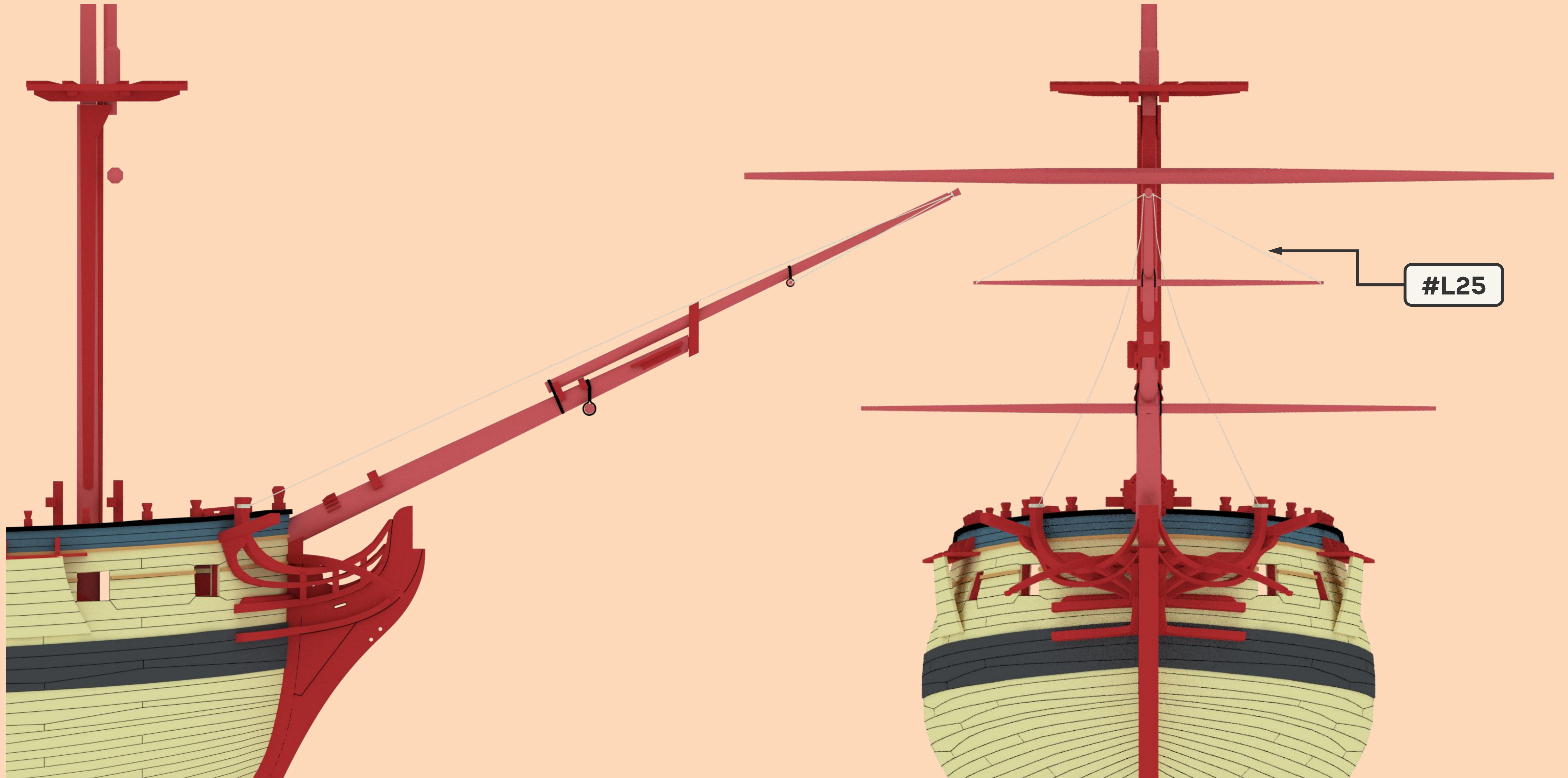

# 39. SPRITSAIL TOPSAIL LIFT

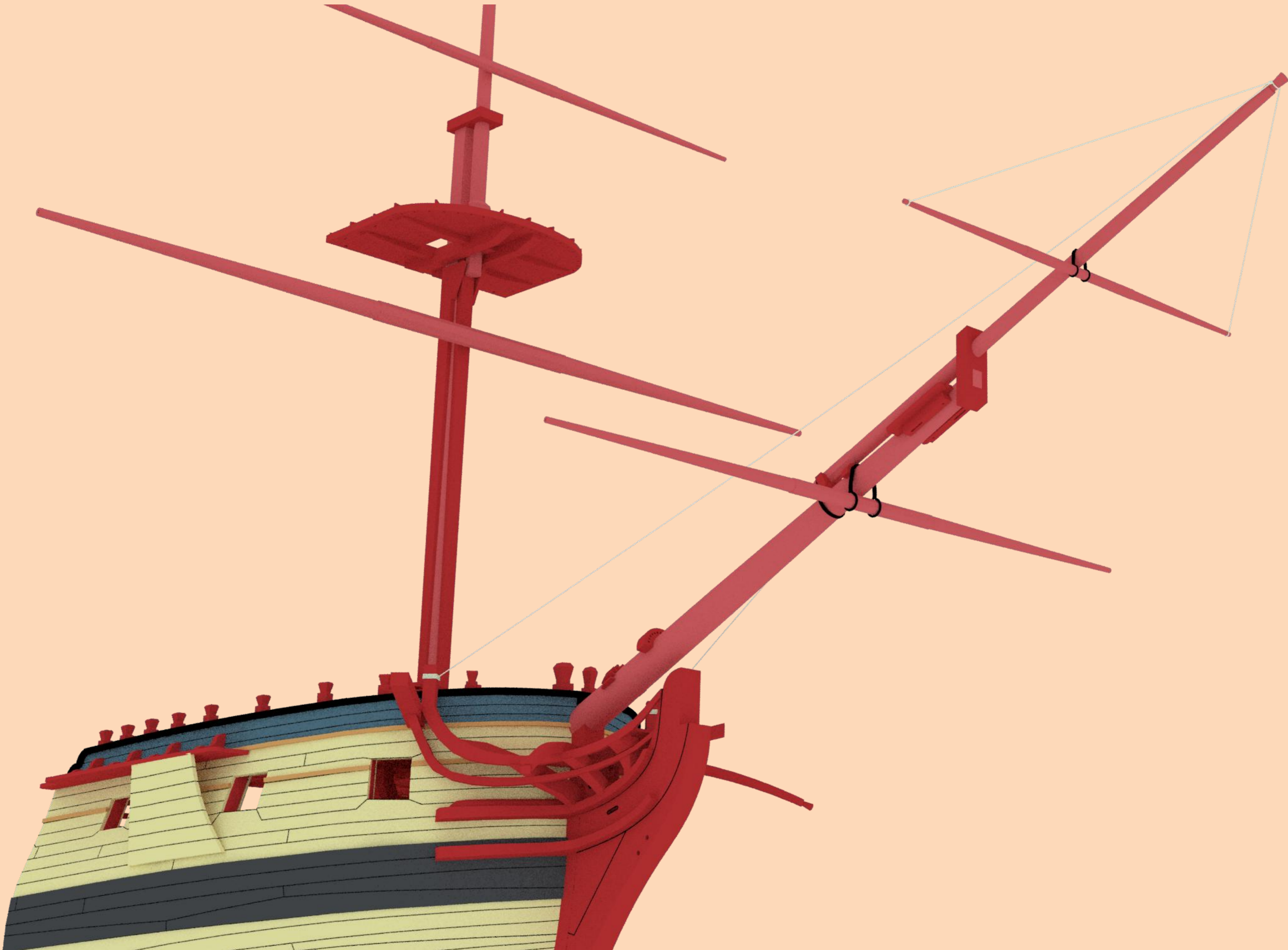

# STEP 17-39

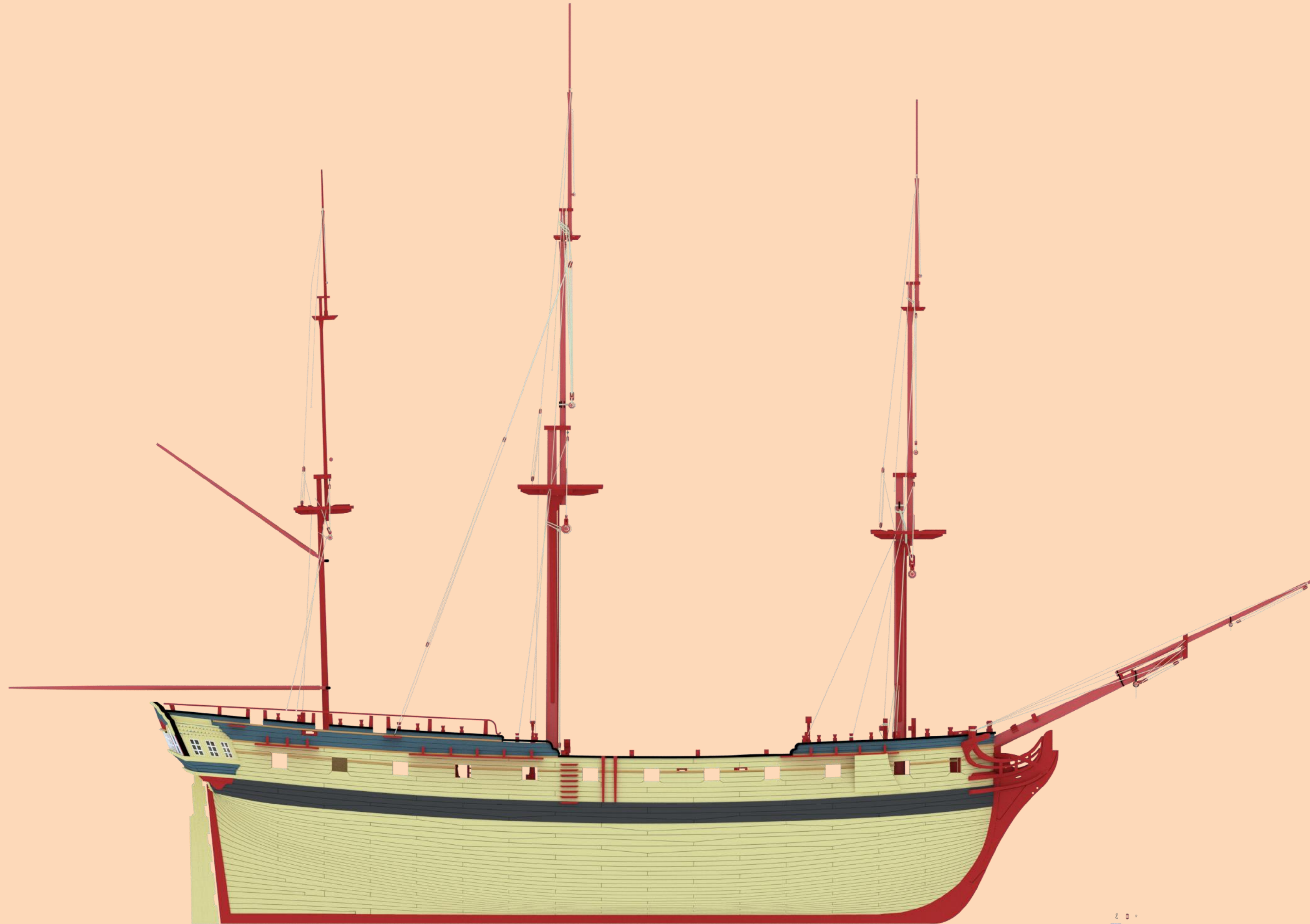



# CONTENTS SO FAR



# 36. BOOM TOPPING LIFT

## DETAILS

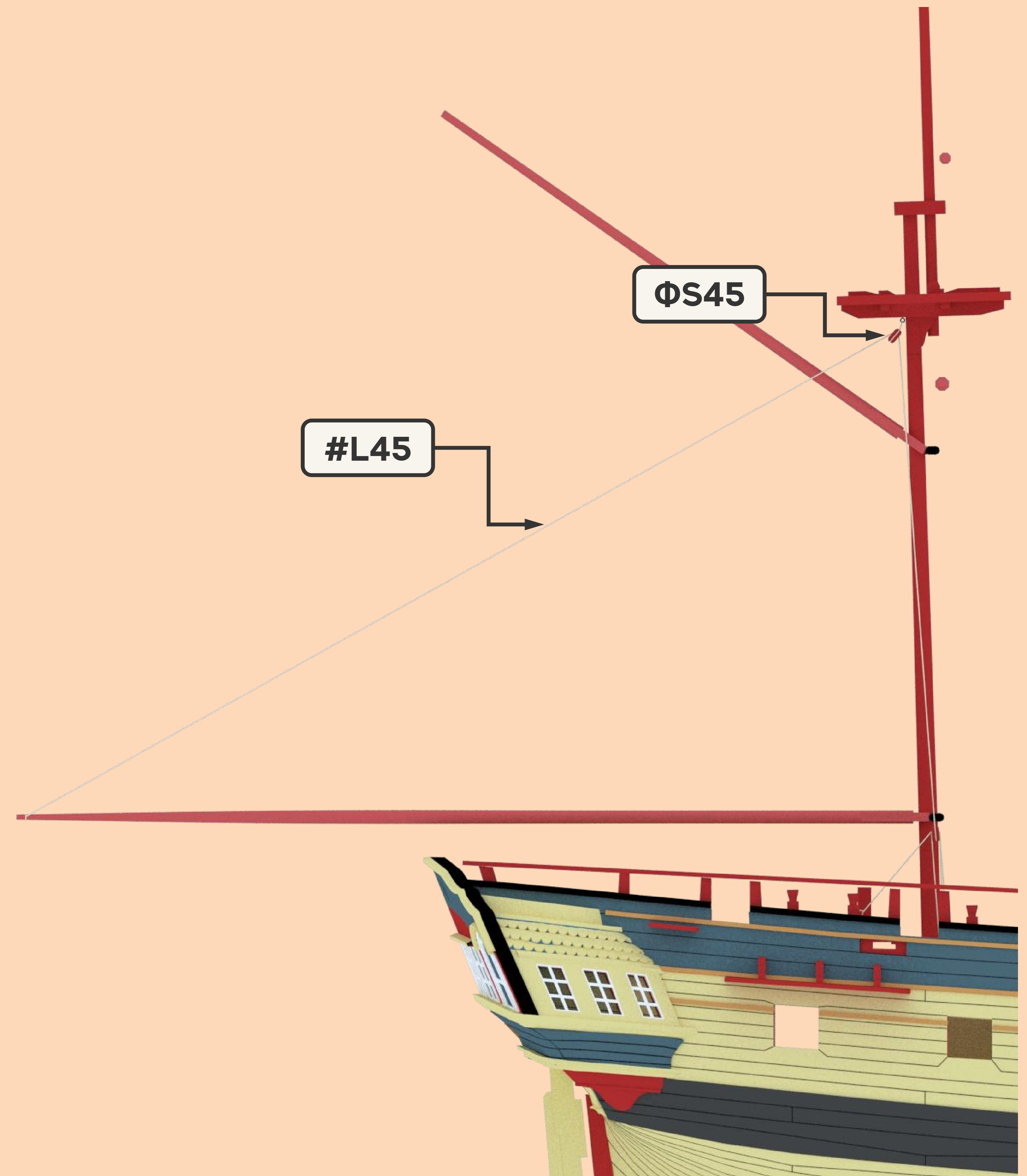
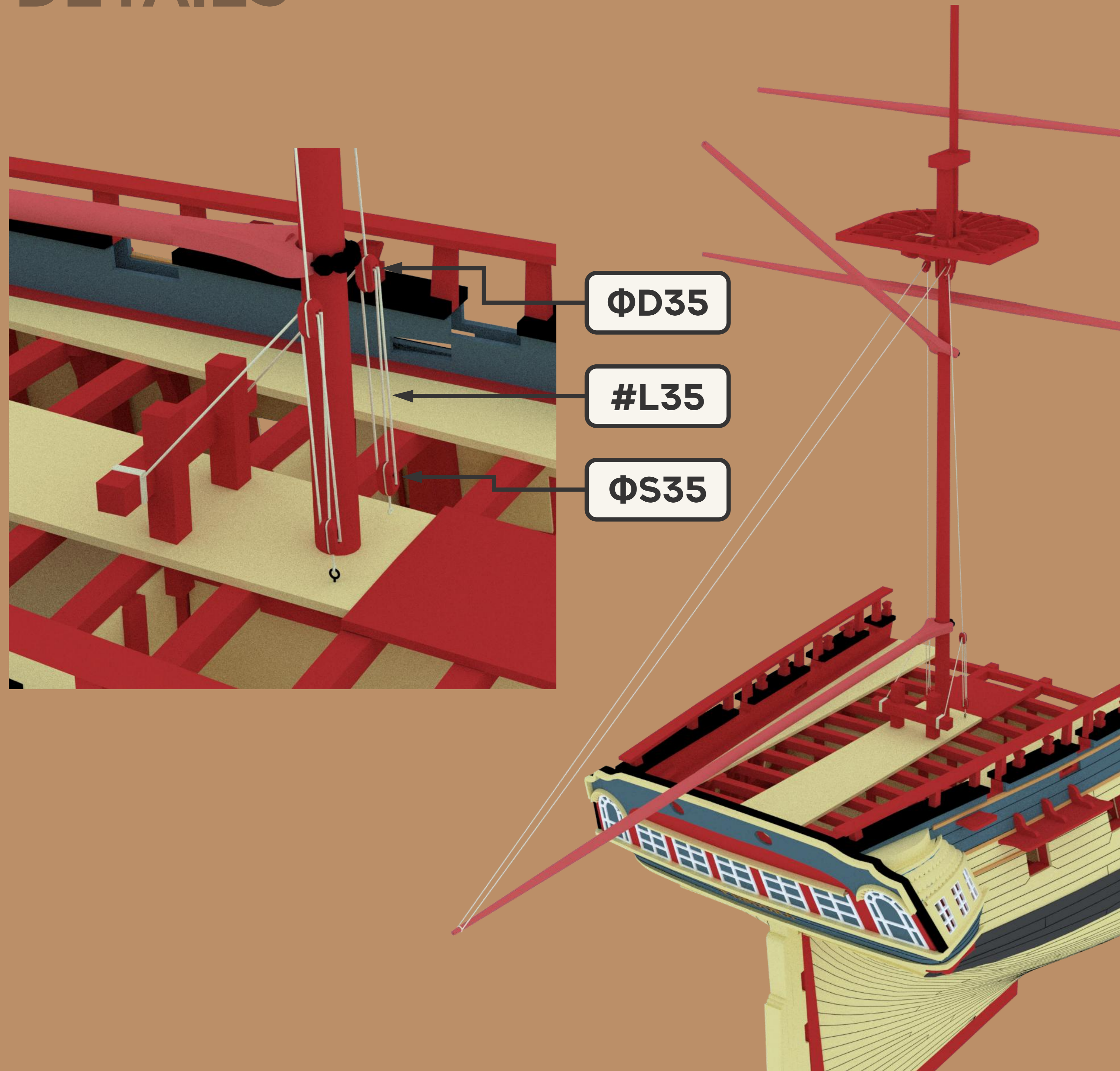

# 37. SPANKER BOOM SHEET

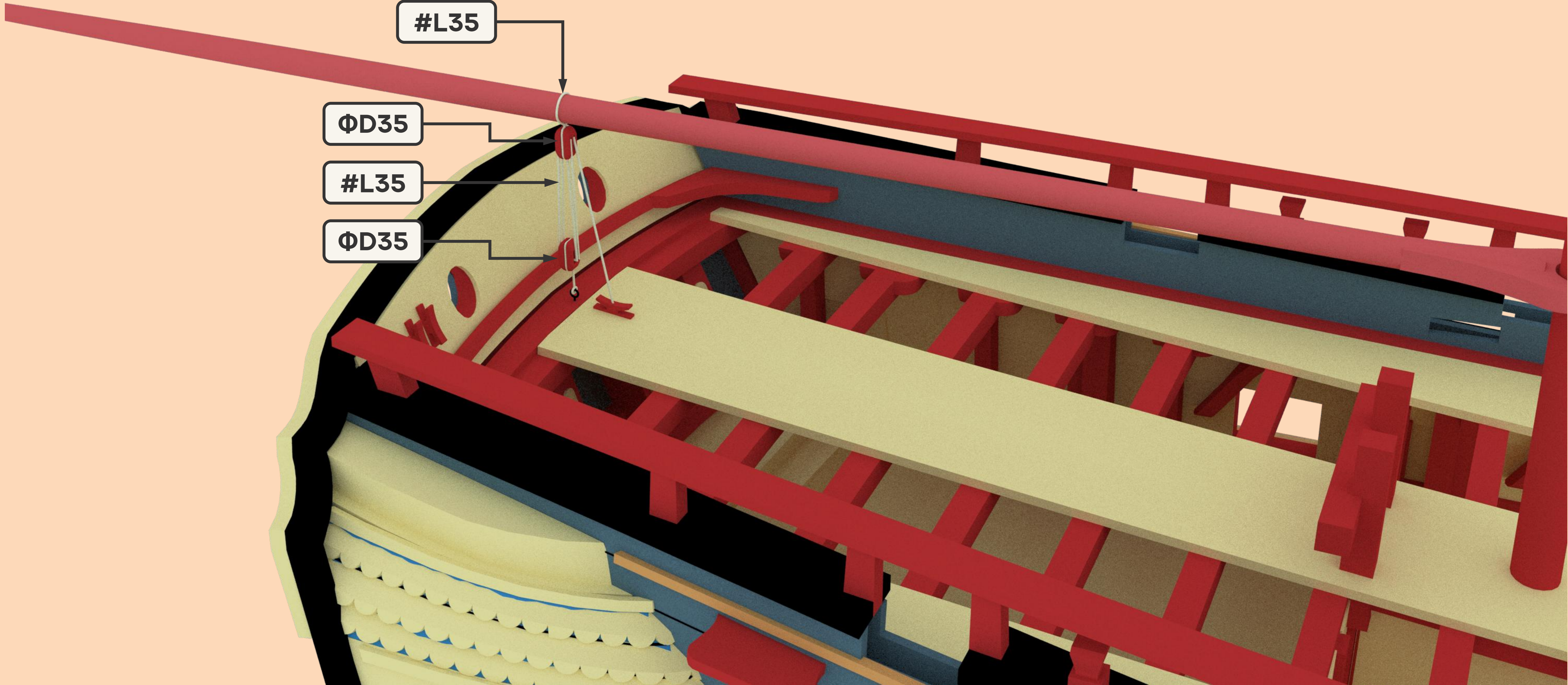

# 38. GUY PENDANTS

## DETAILS

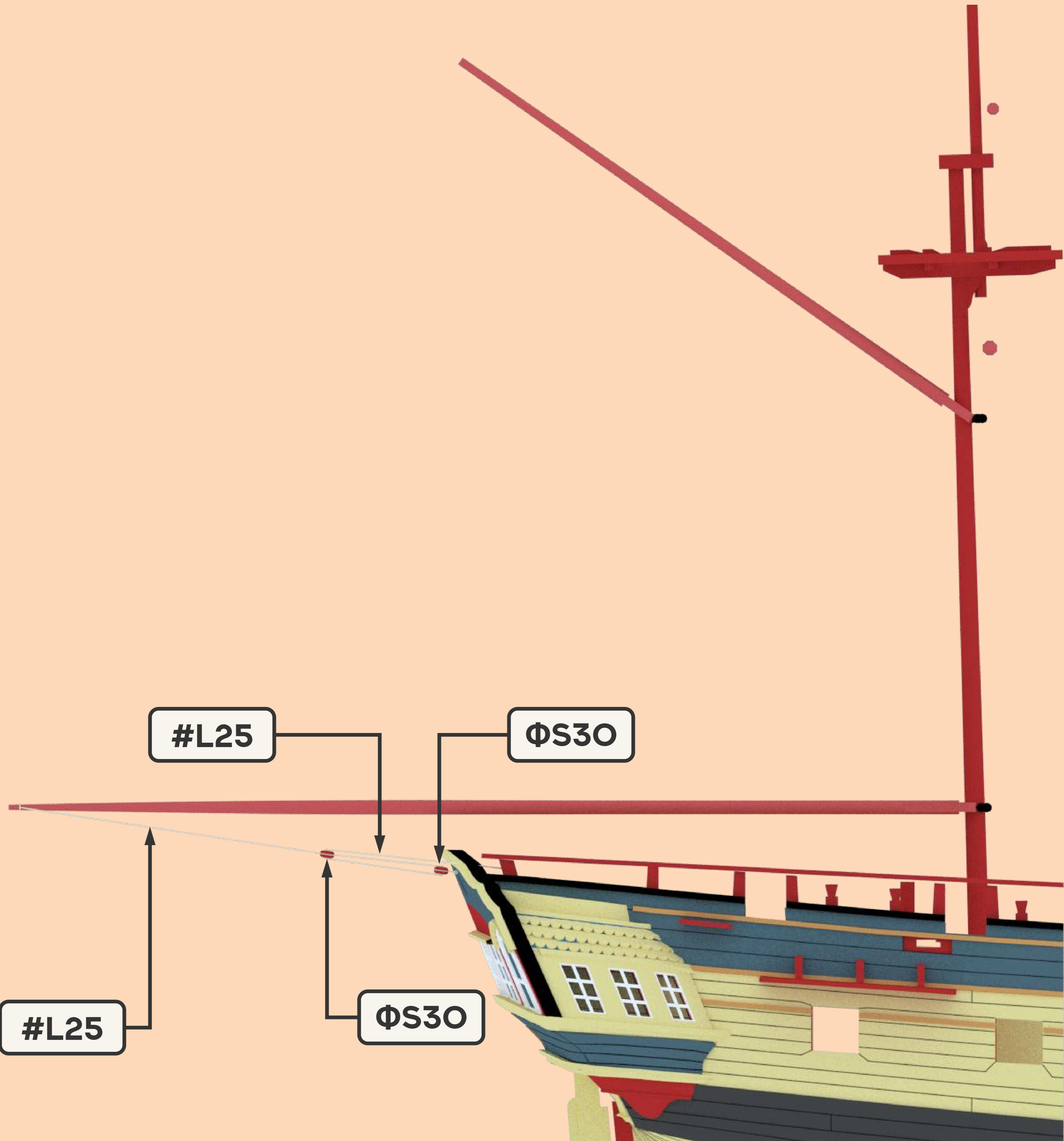
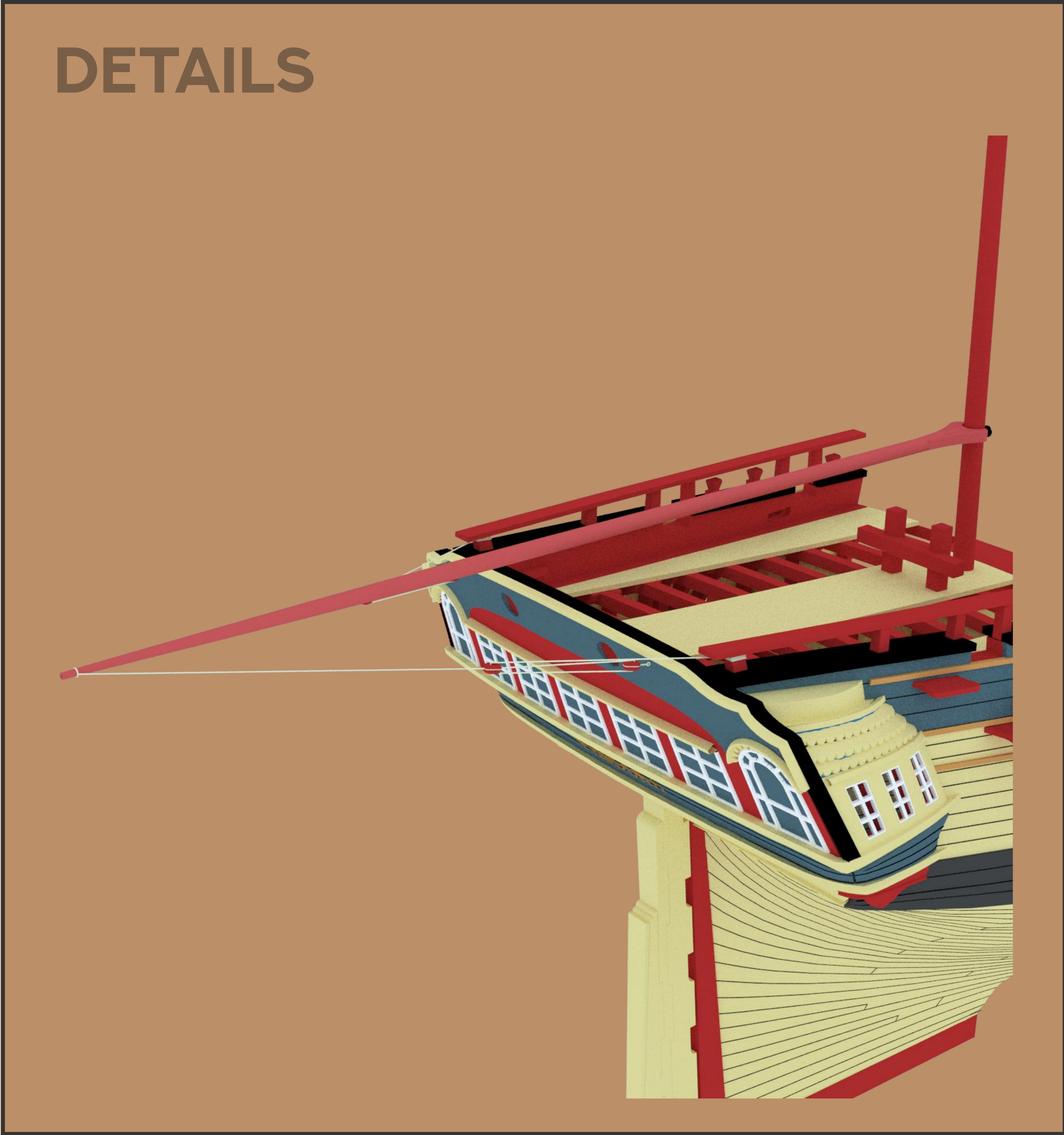

# 39. THROAT HALLIARD

## DETAILS

ΦD40

#L35

ΦS40

ΦS30

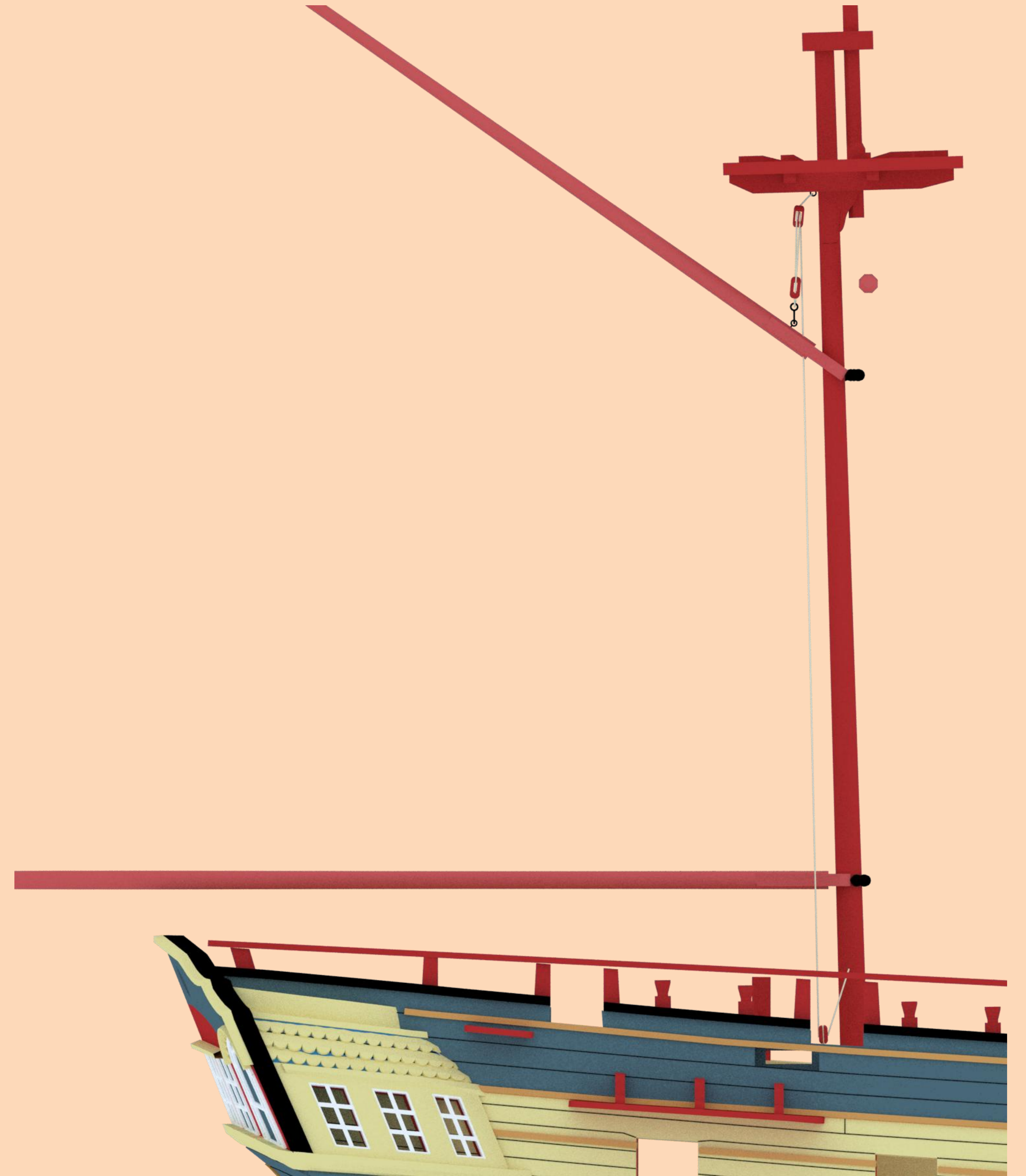
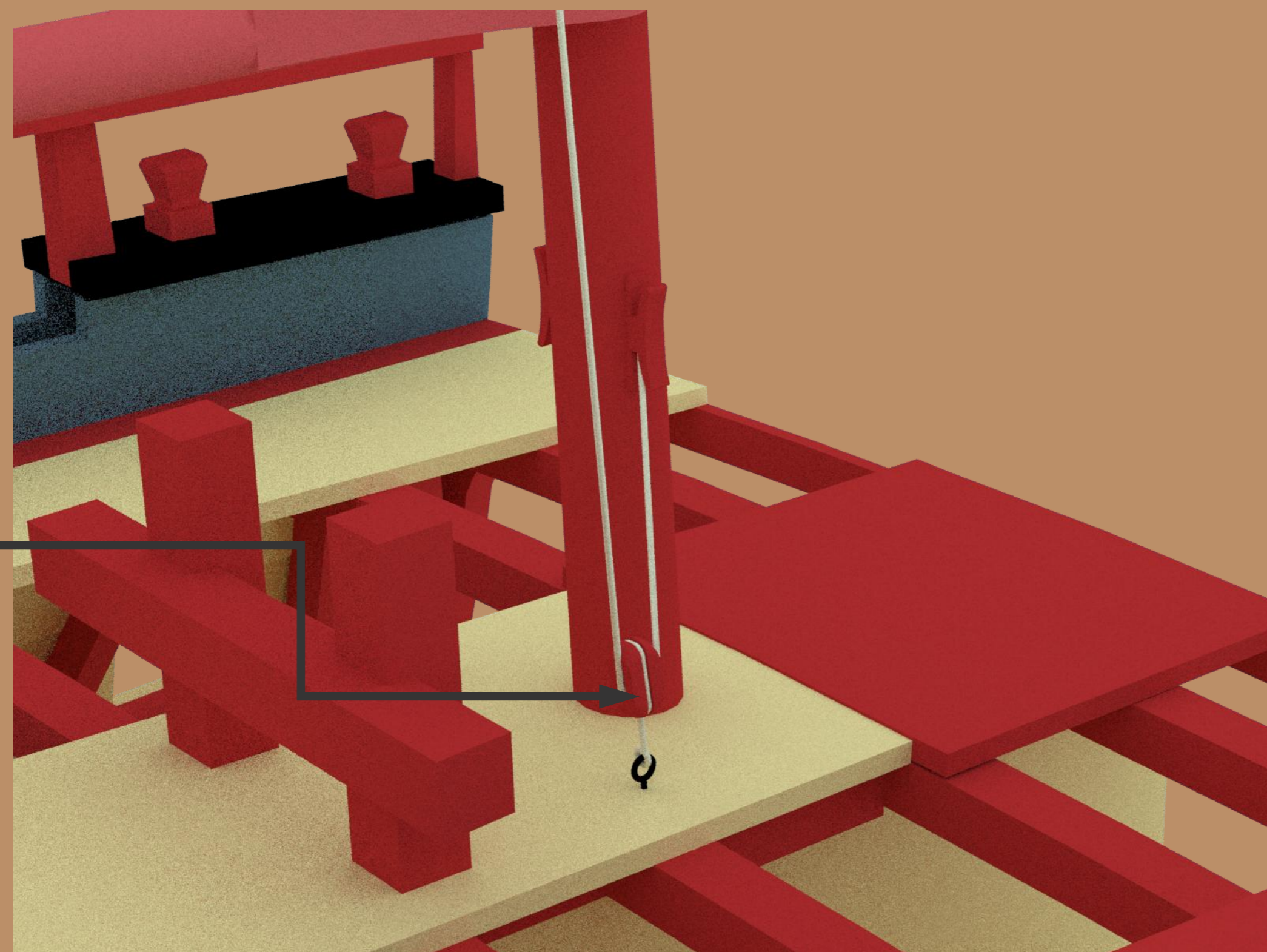
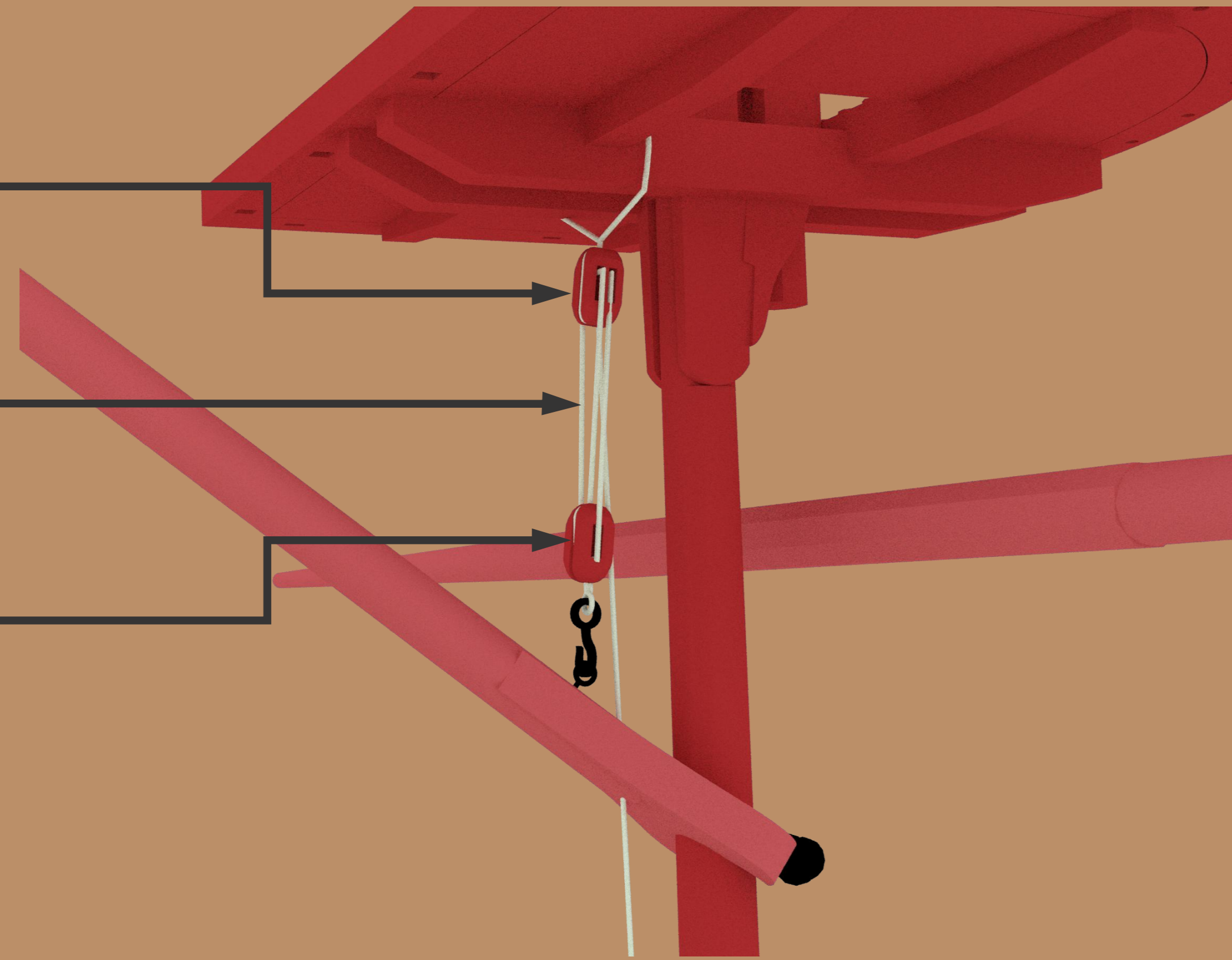

# 40. PEAK HALLIARD

## DETAILS

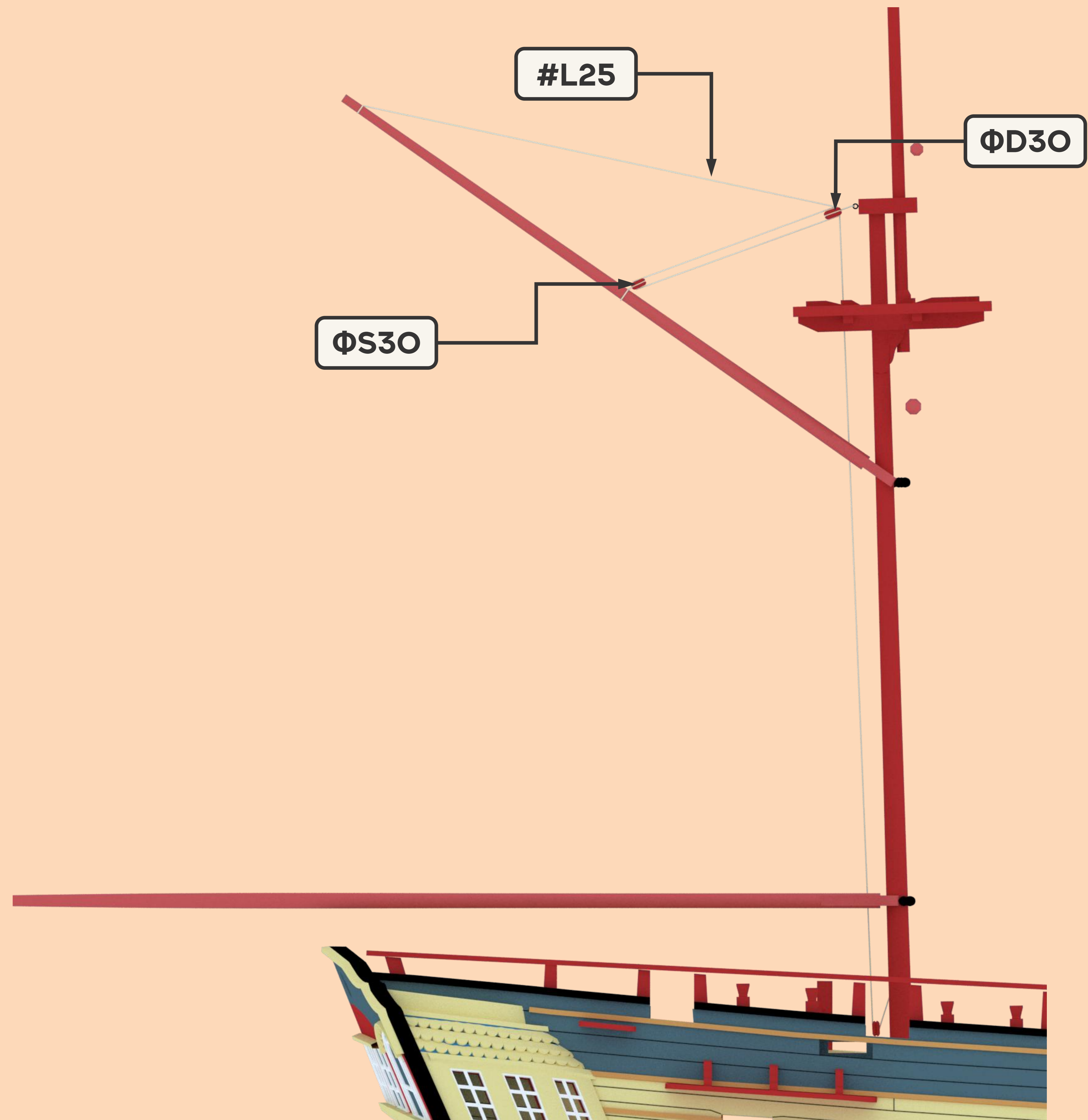
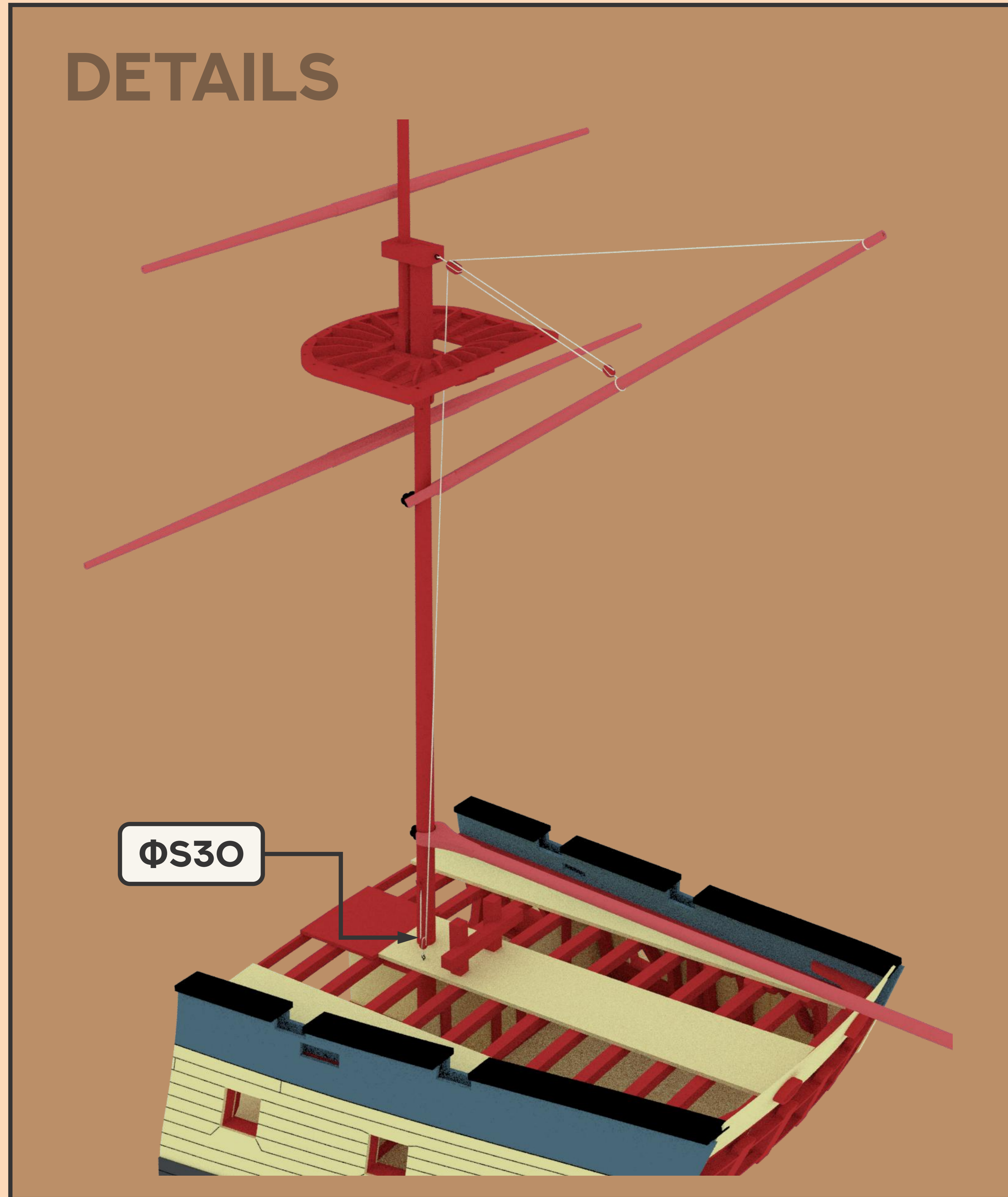

# 41. VANGS

## DETAILS

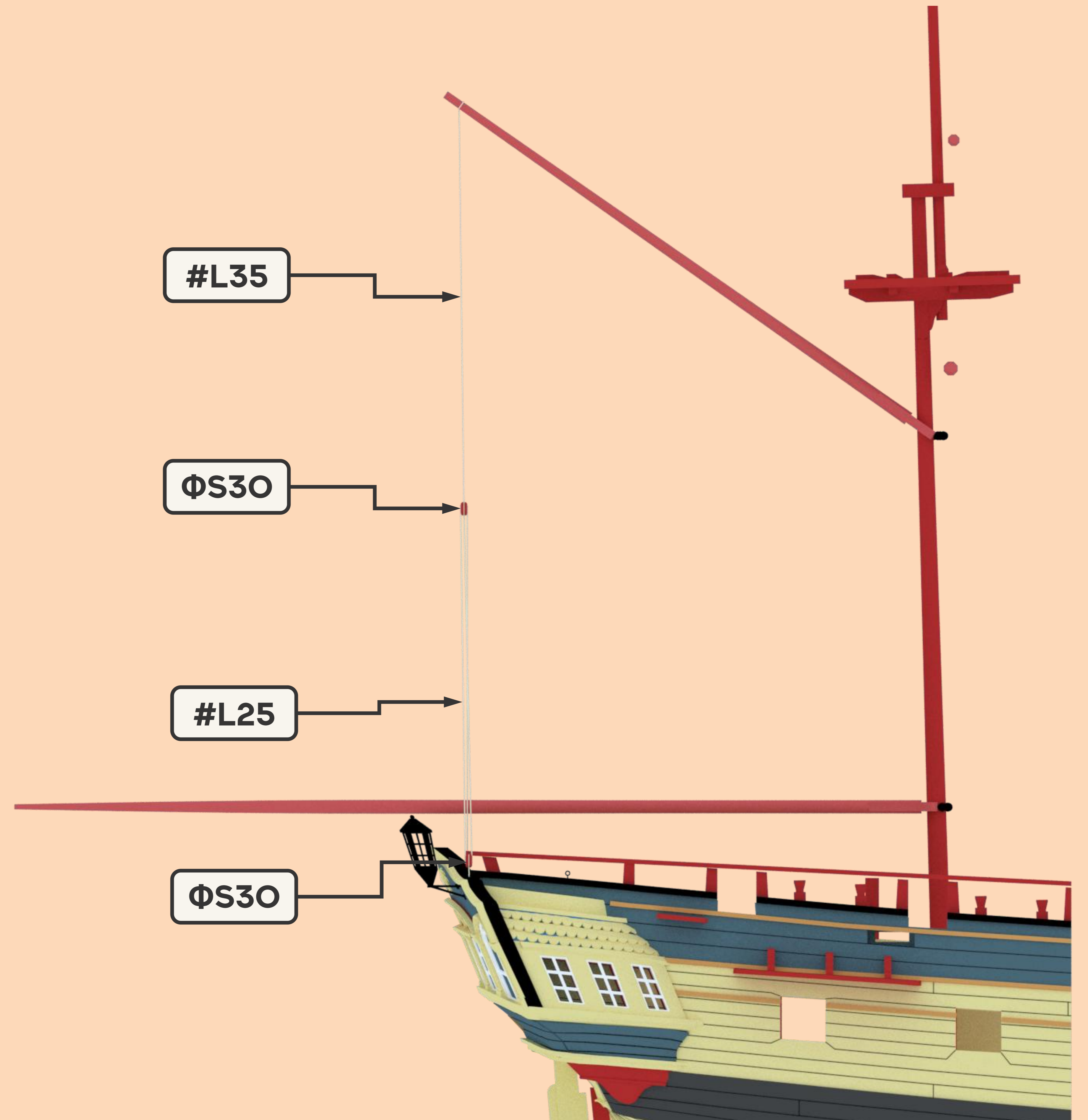
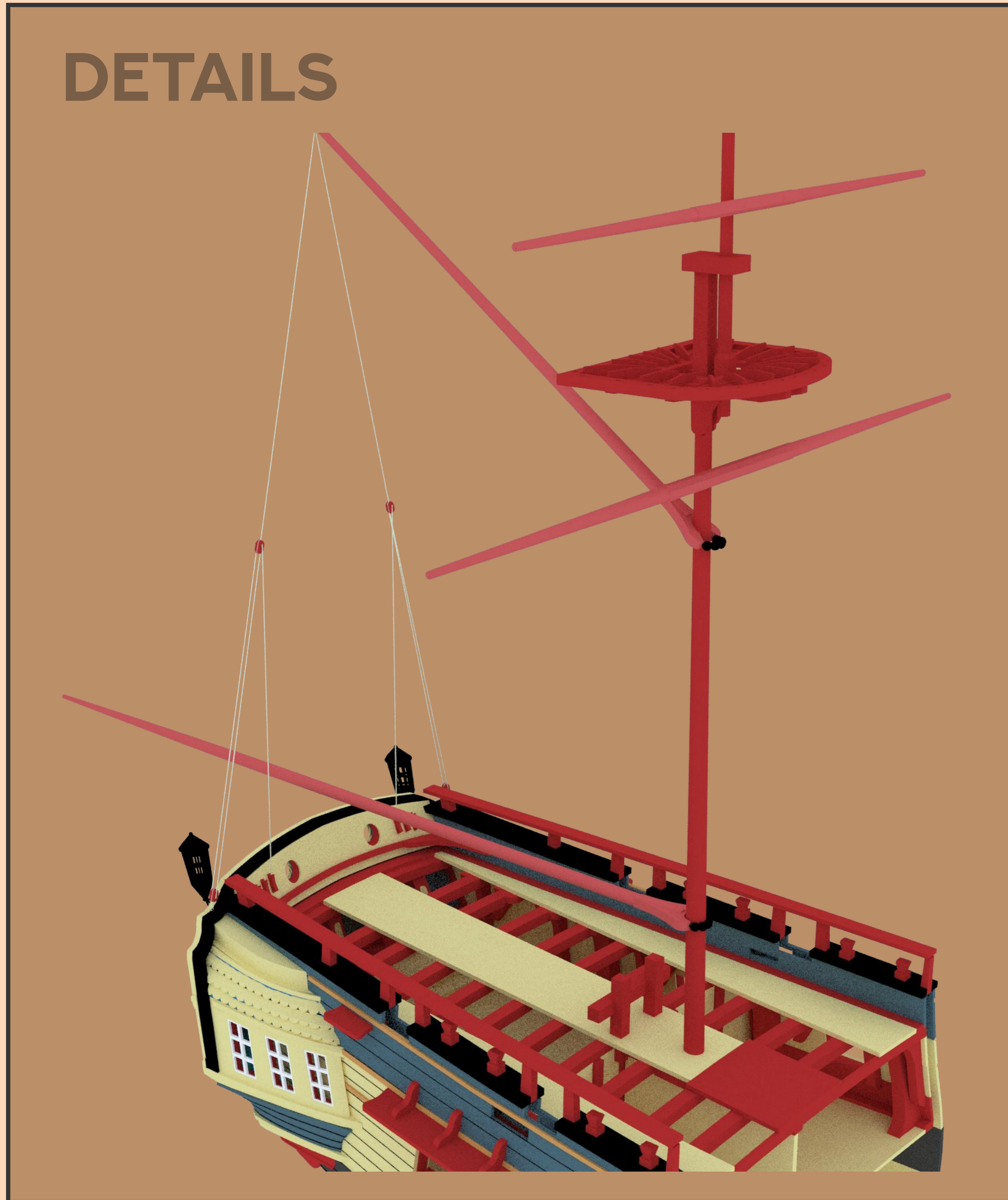

# 42. FORE BARCES

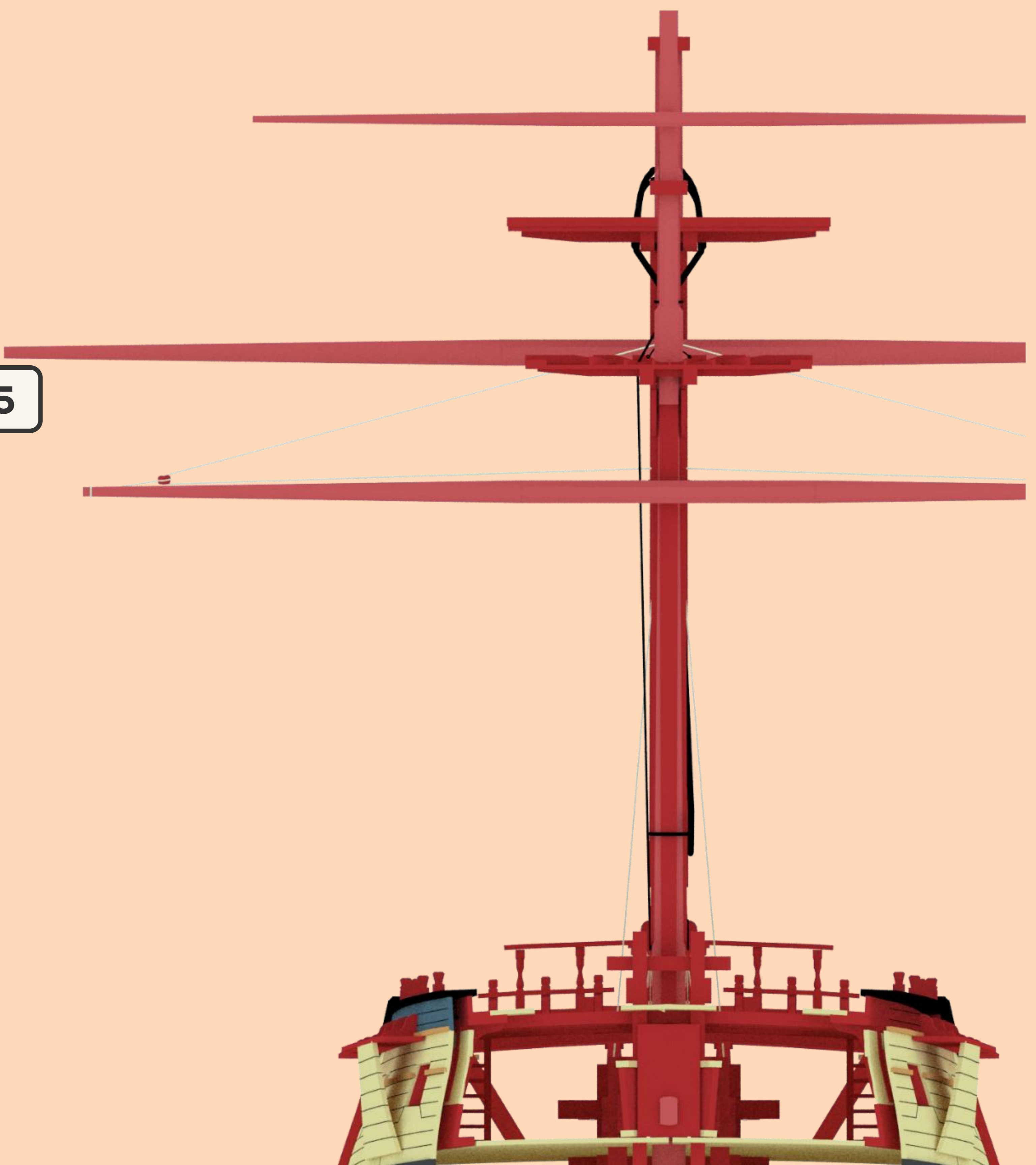
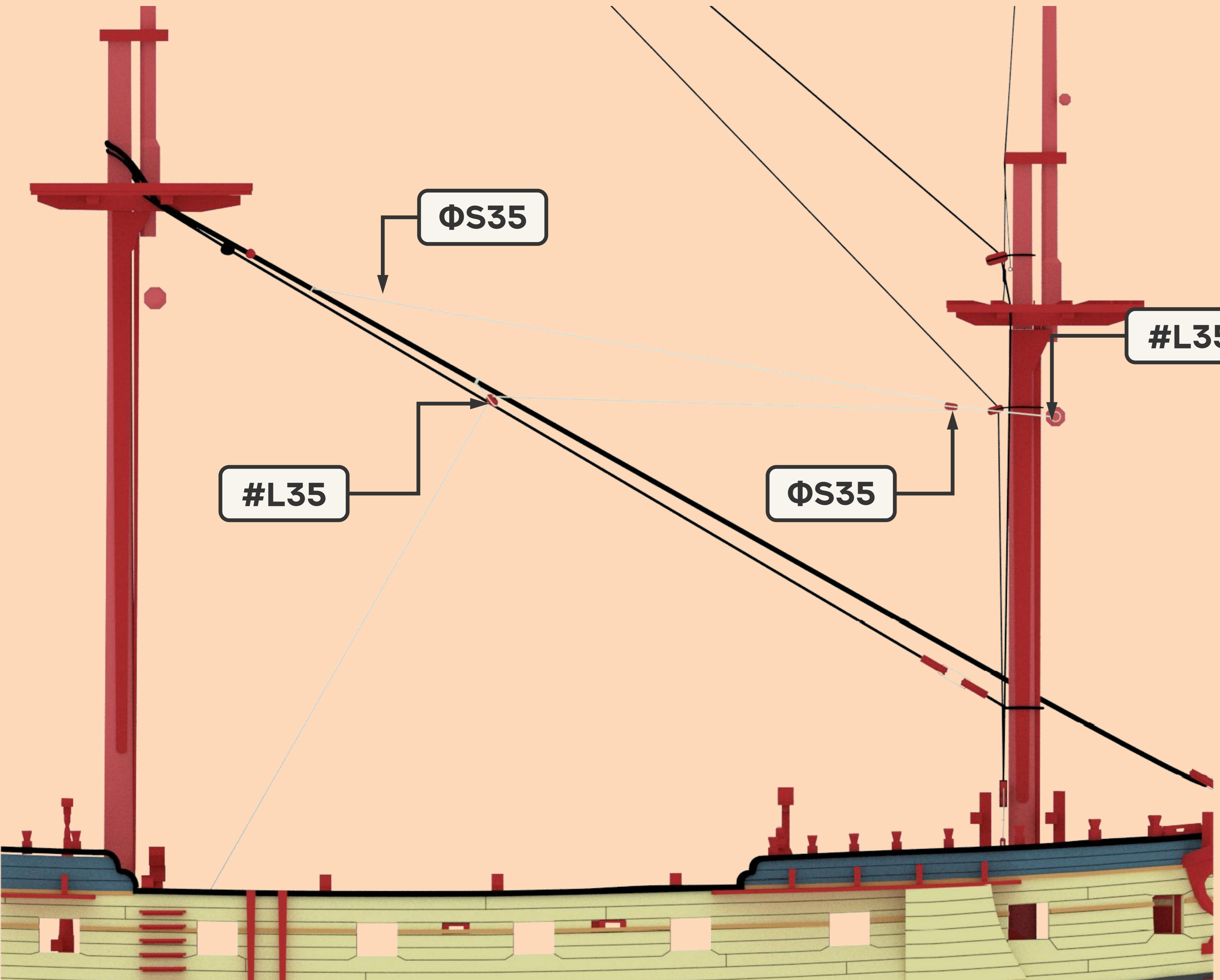



# 42. FORE BARCES

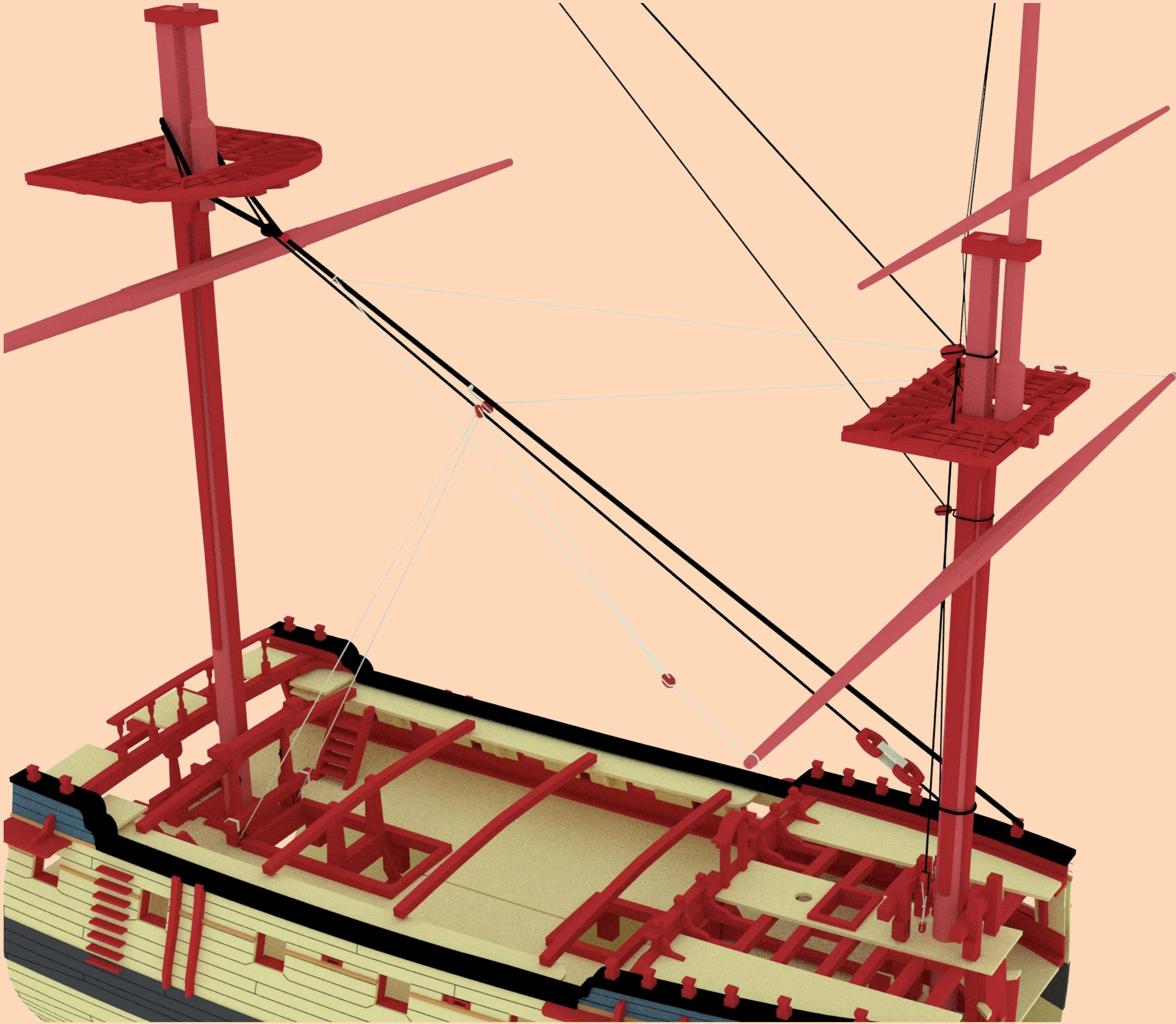

## DETAILS

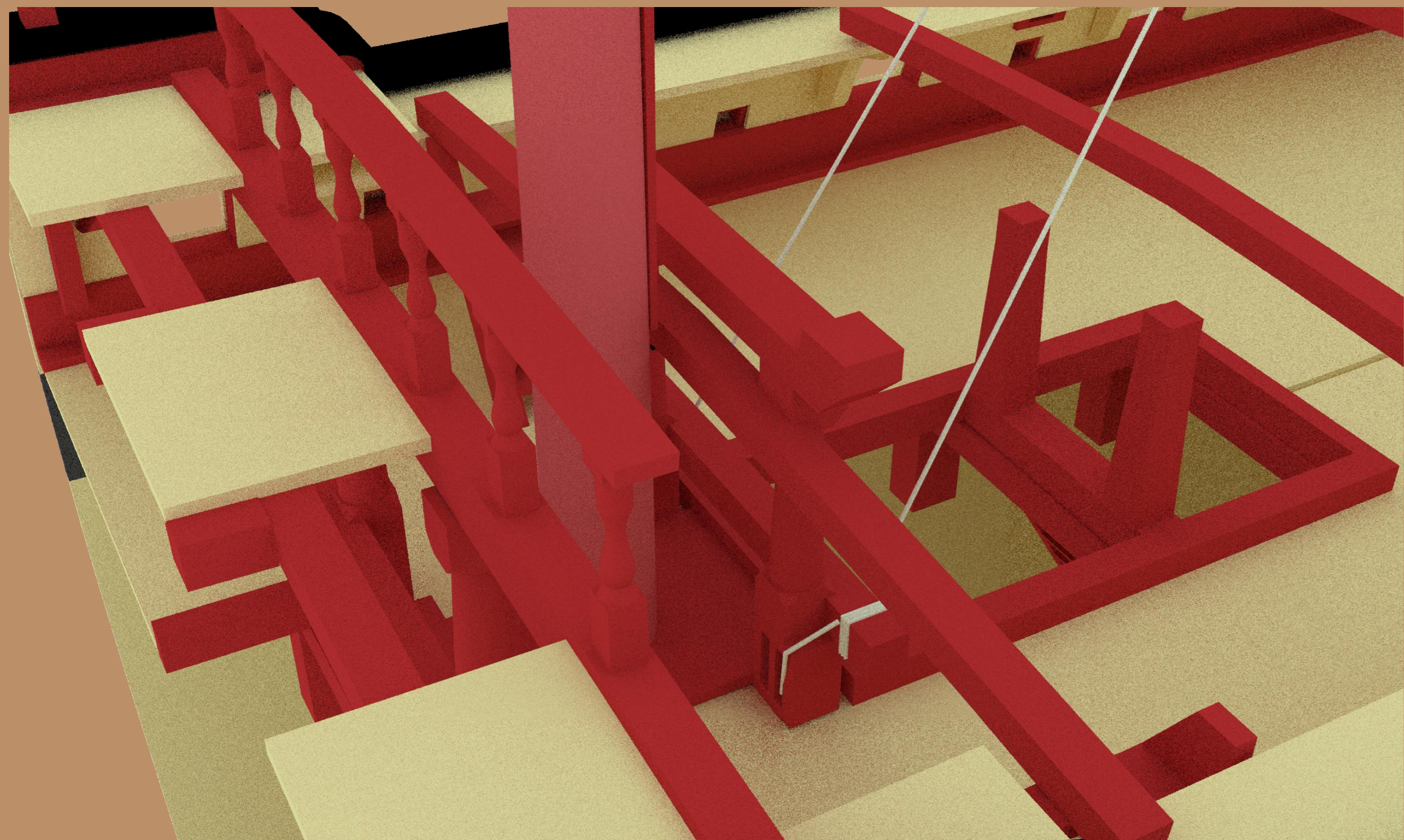

# 43. MAIN BARCES

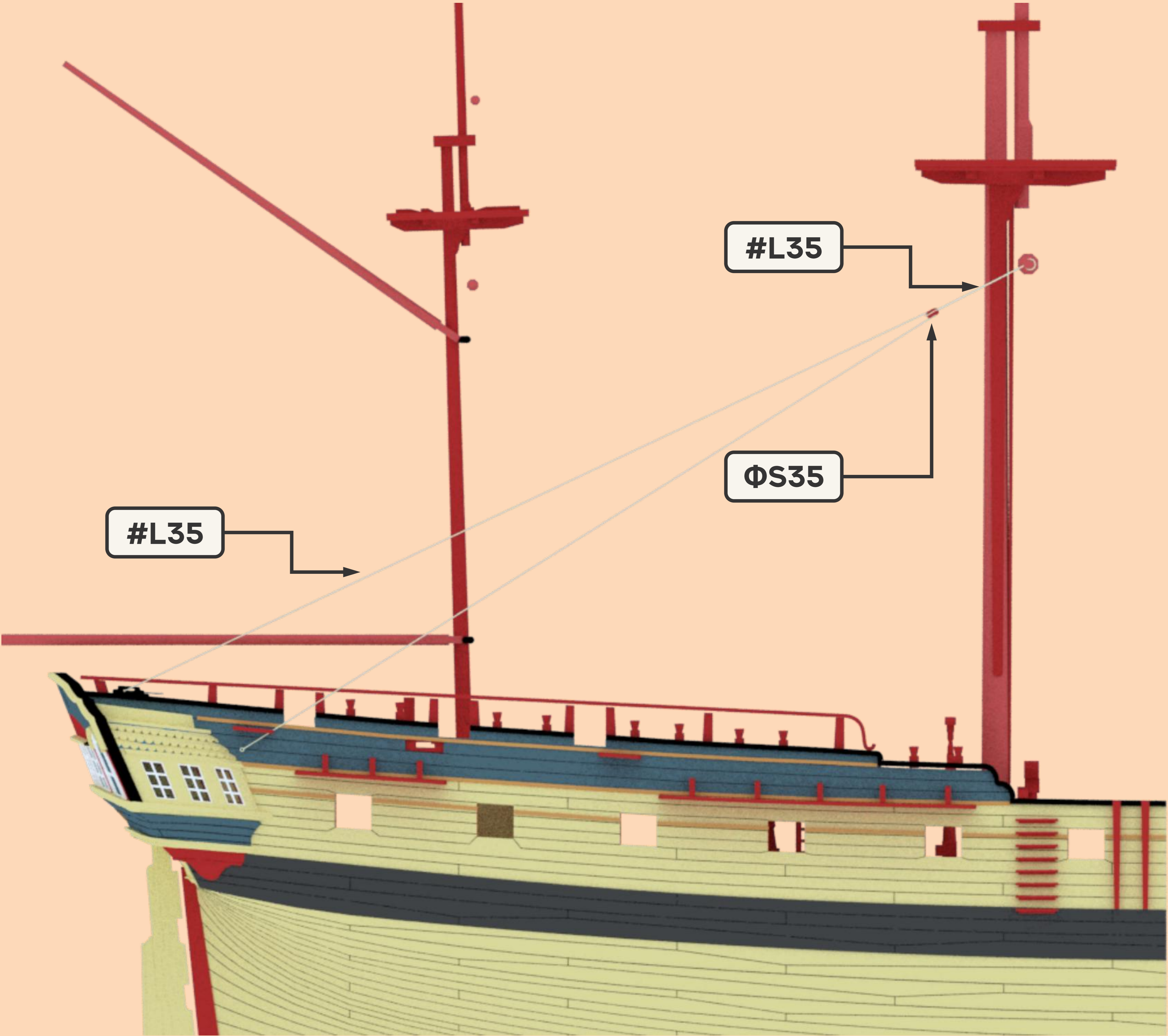
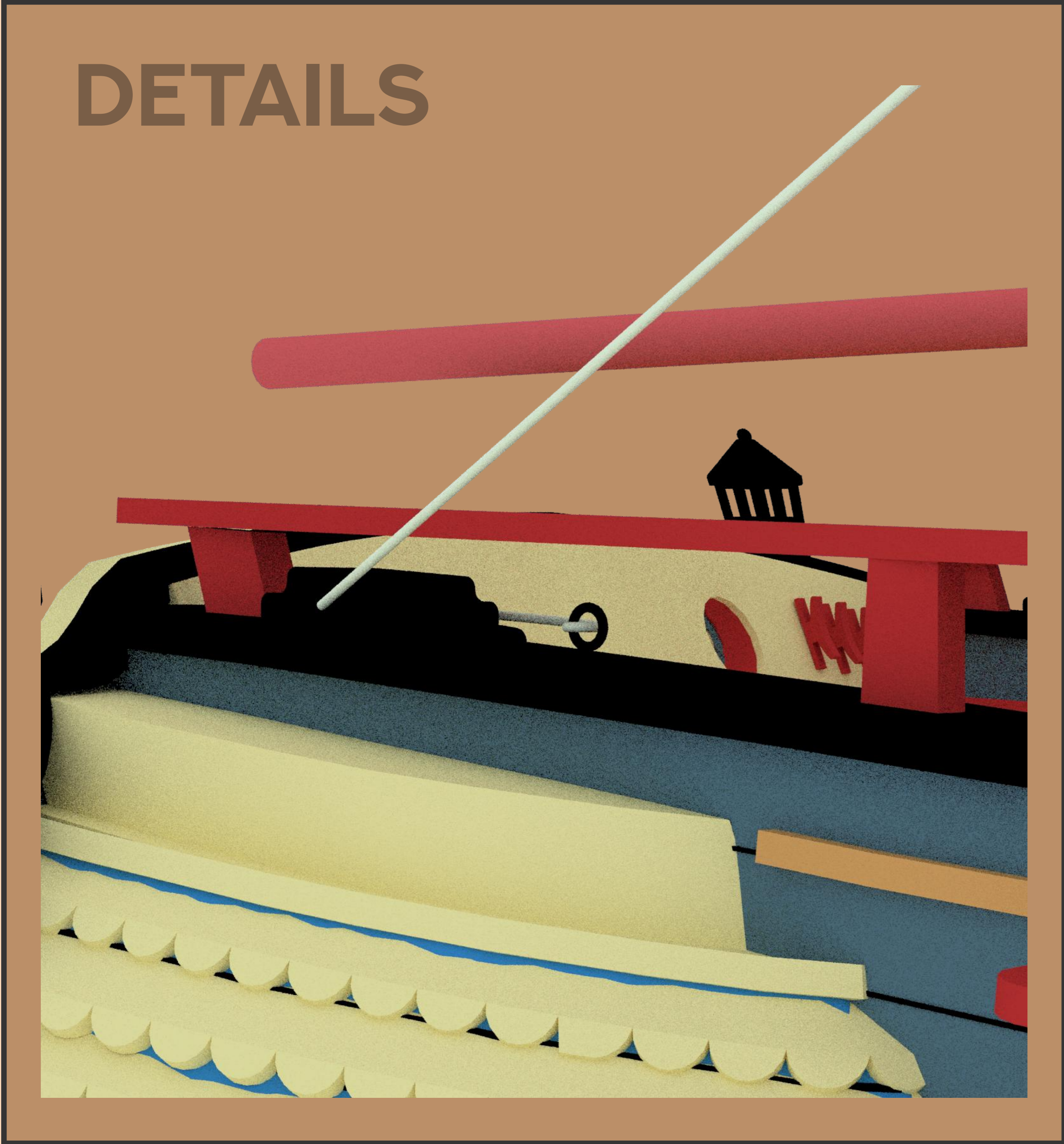

# 44. MIZZEN BARCES

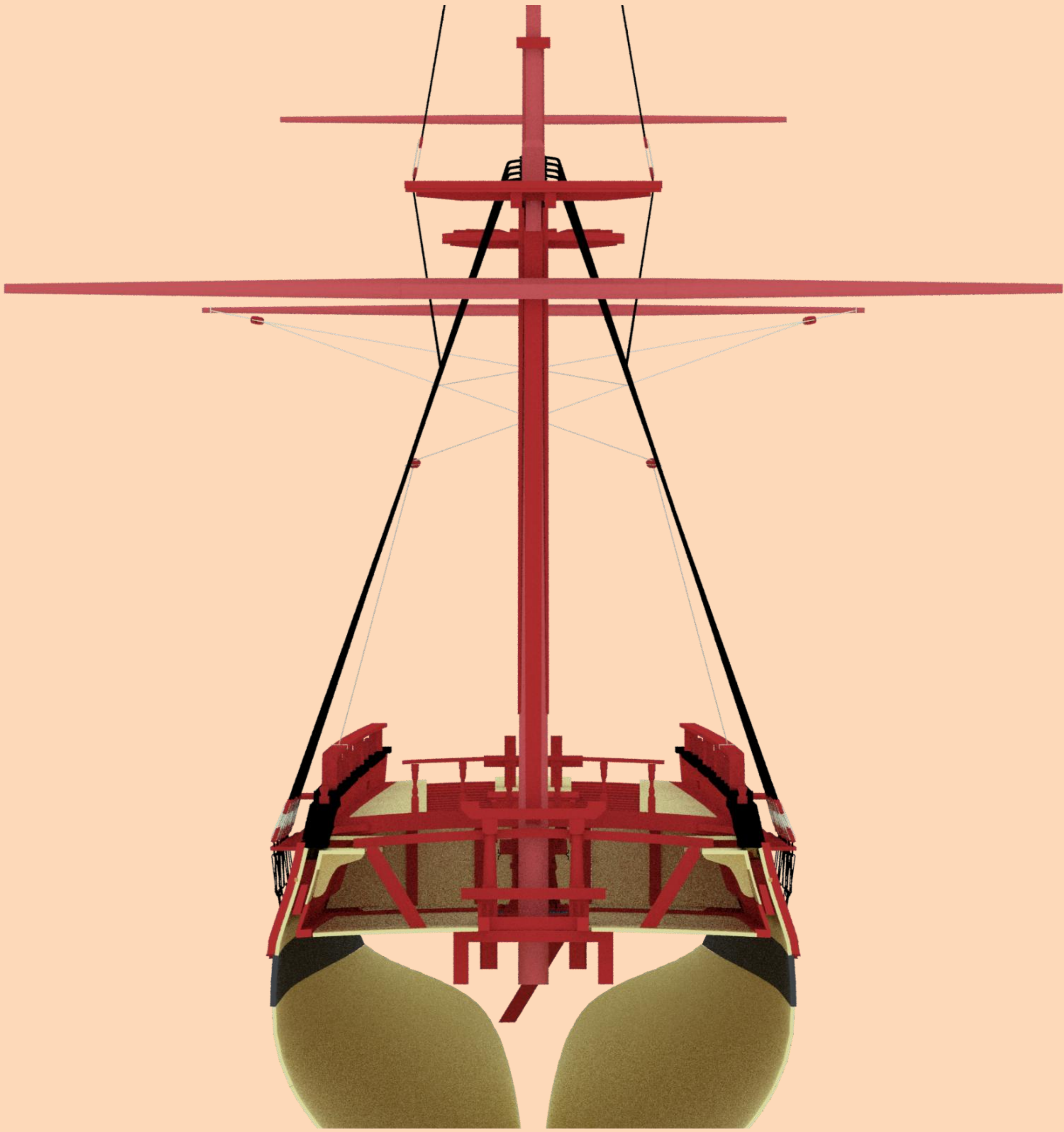
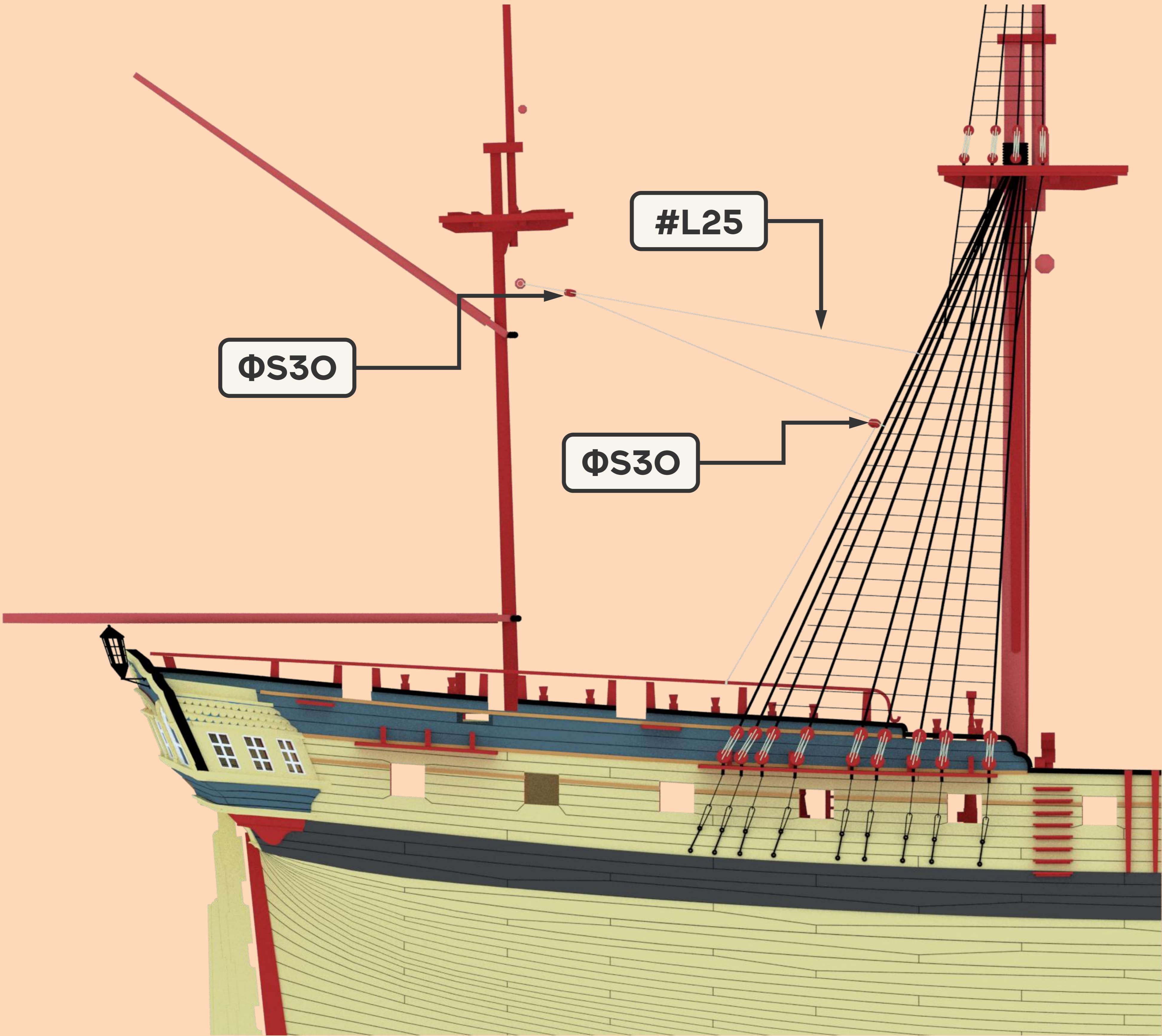

# 44. MIZZEN BARCES

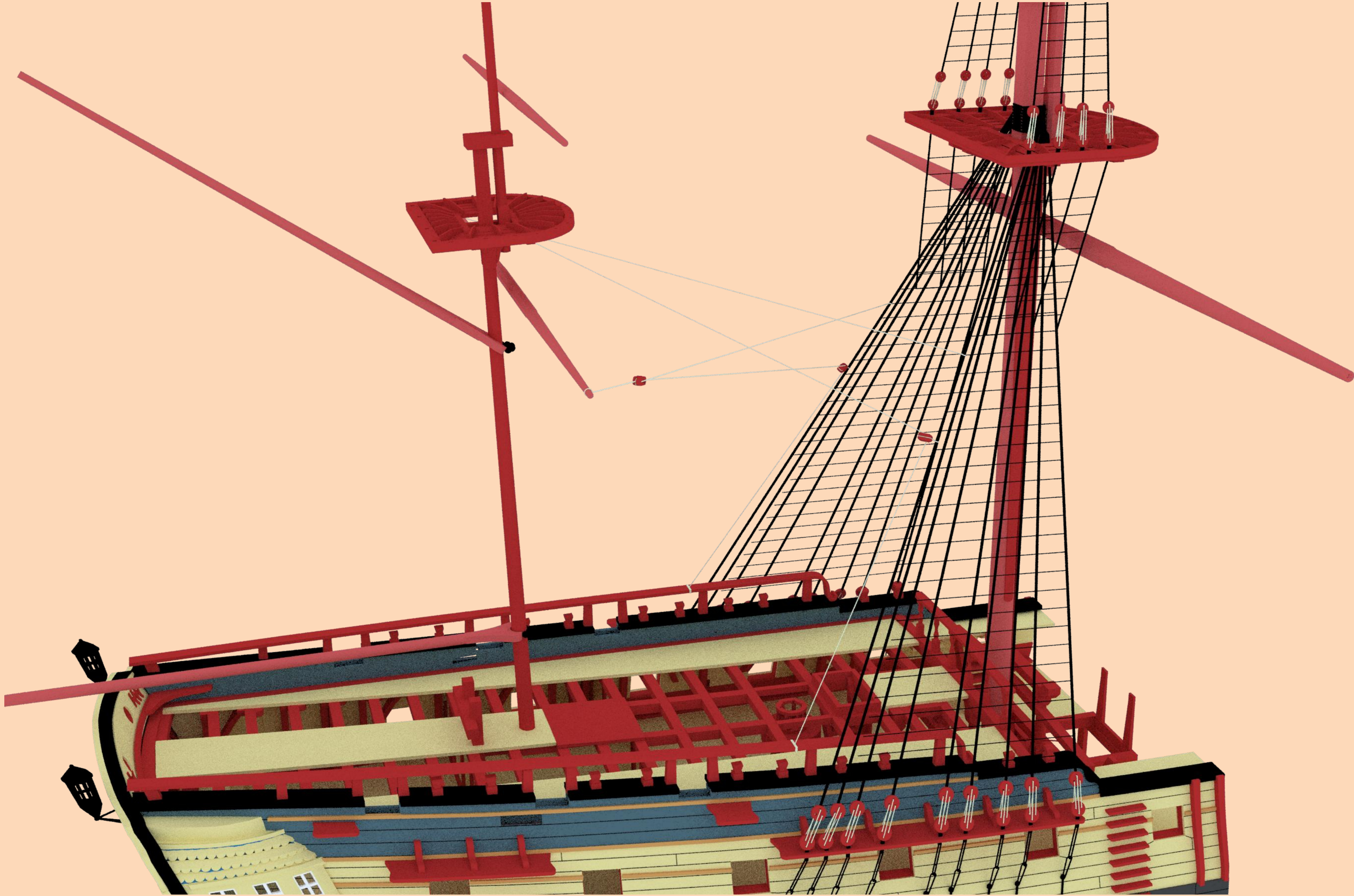

# 43. FORE TOPSAIL BARCES

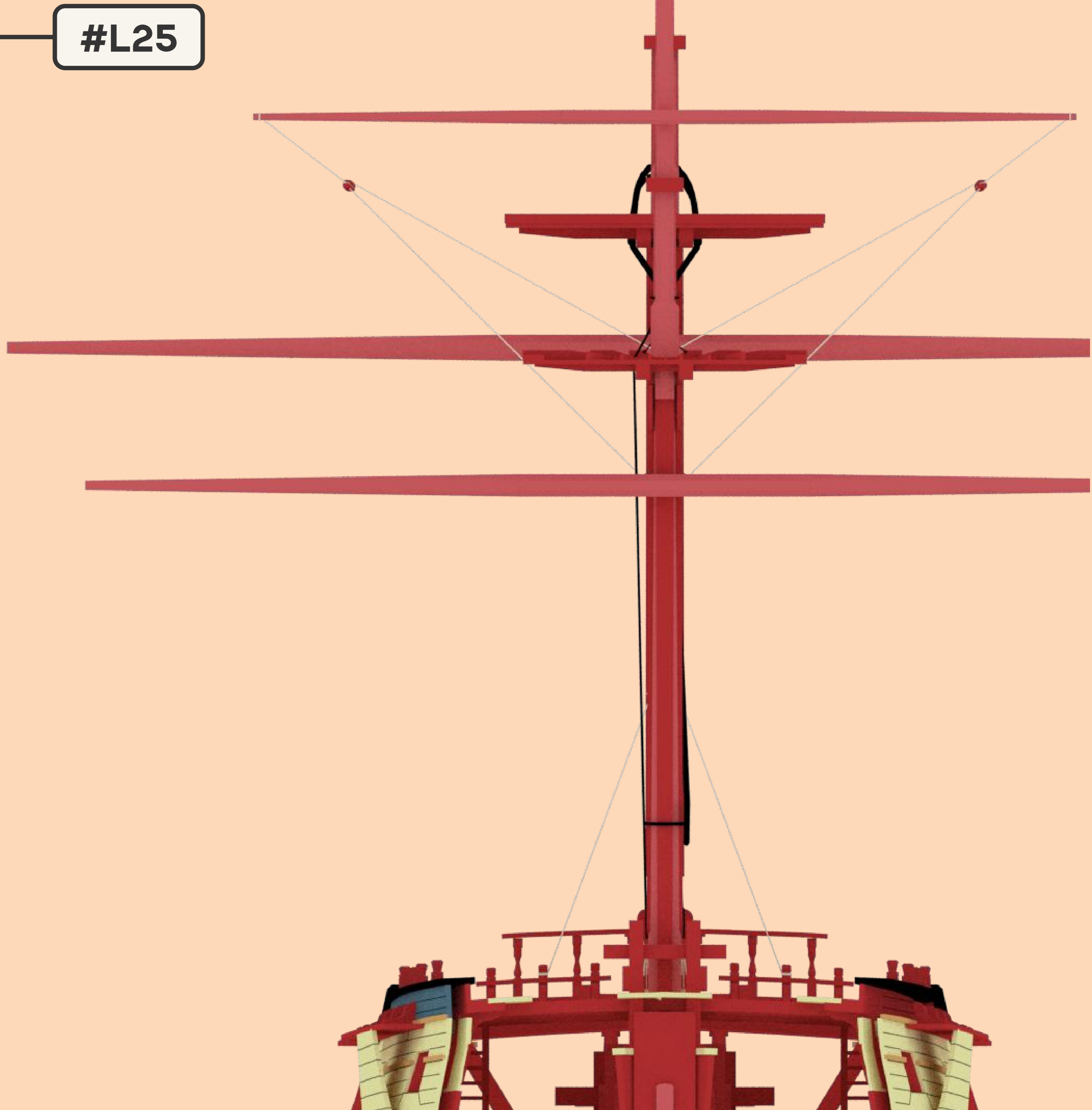
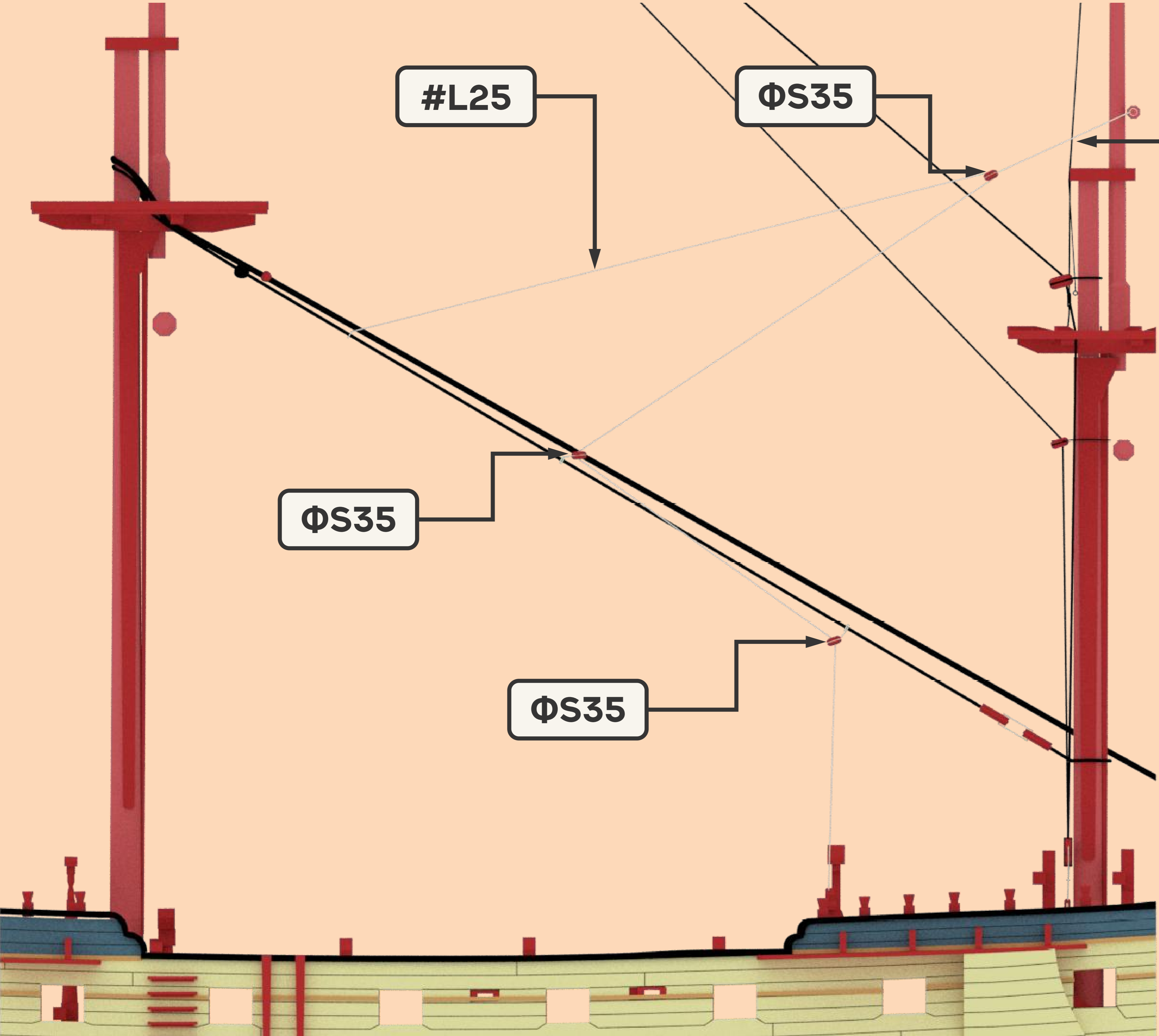

# 43. MAIN TOPSAIL BARCES

## DETAILS

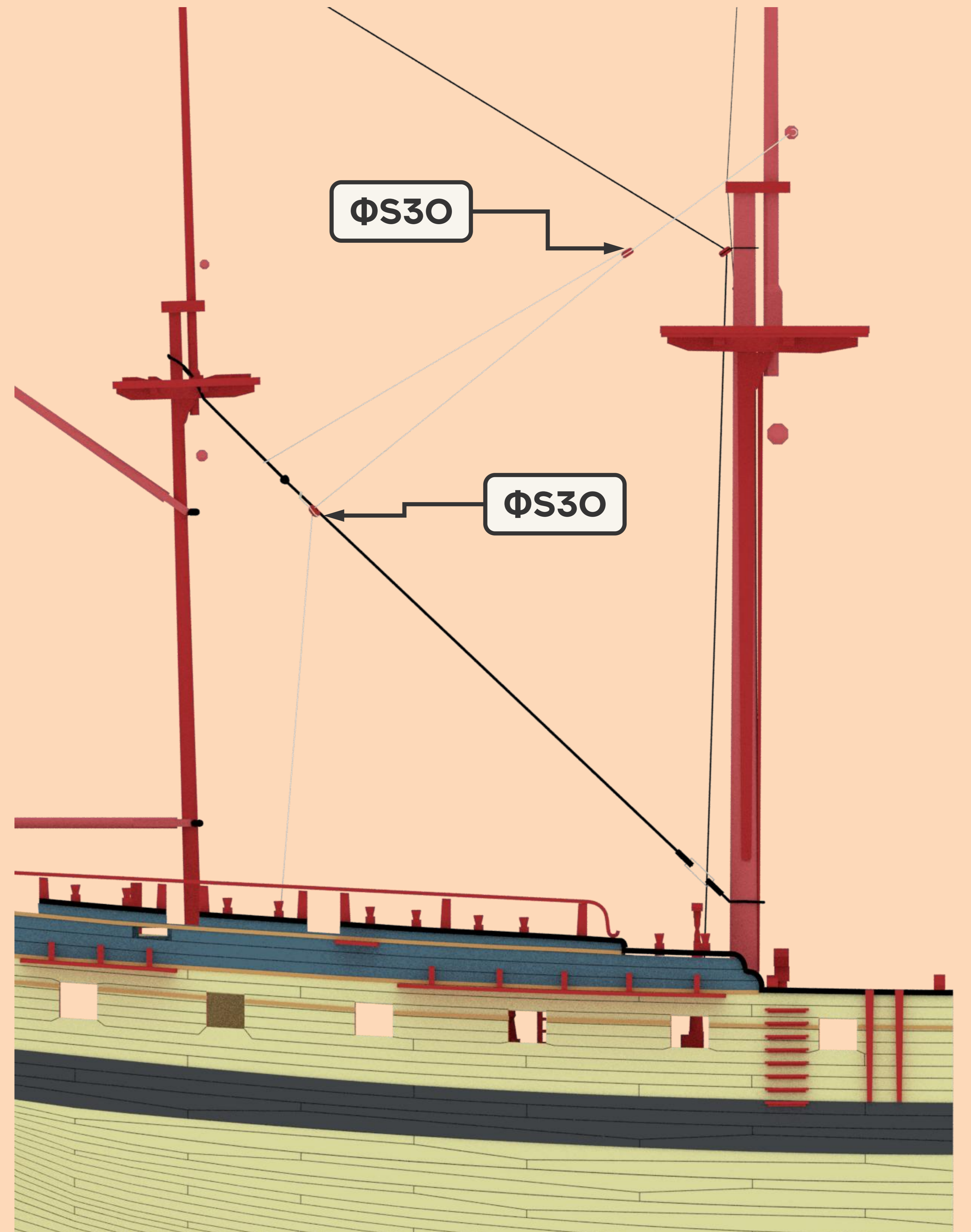
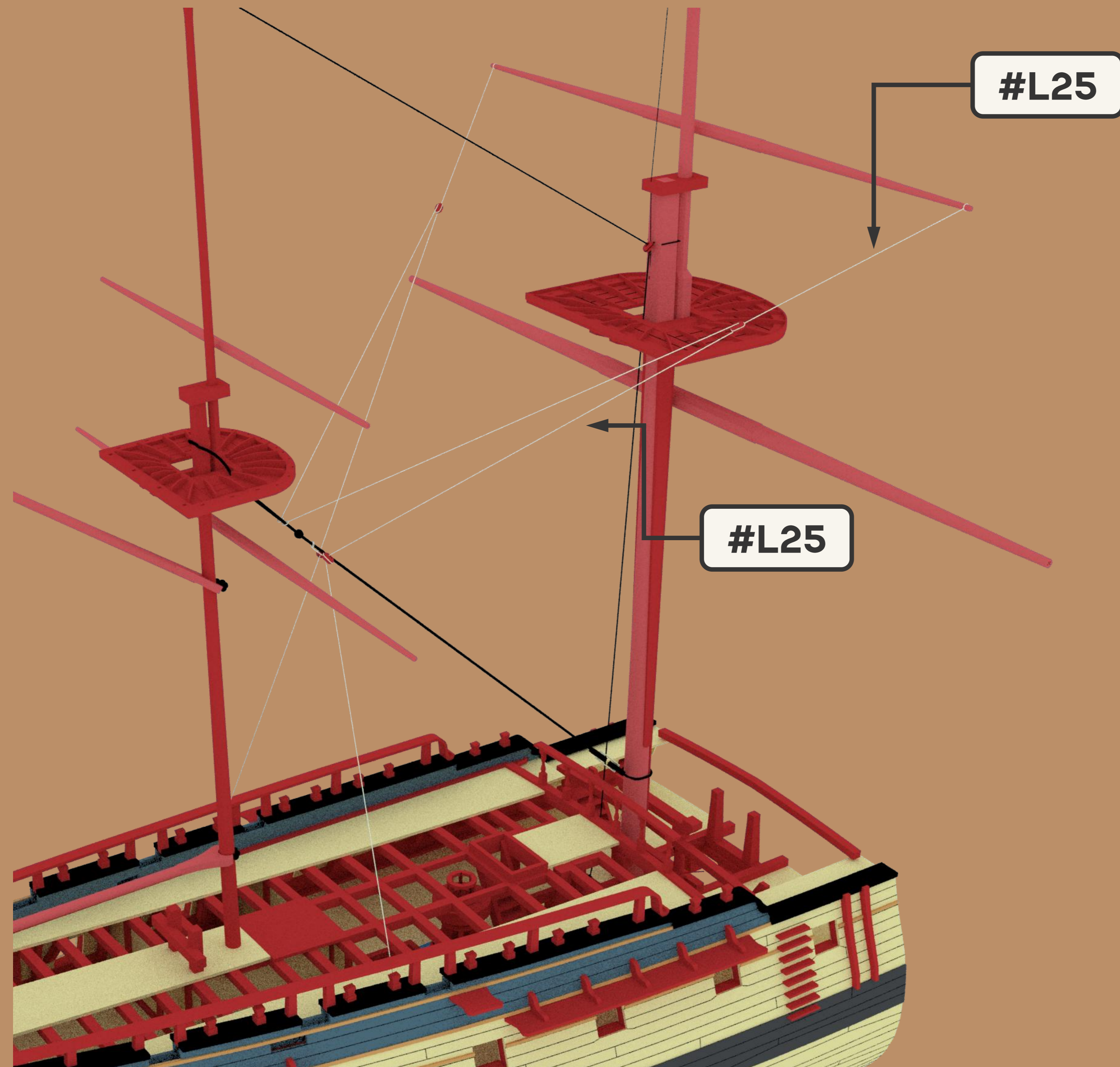

# 43. MIZZEN TOPSAIL BARCES

## DETAILS

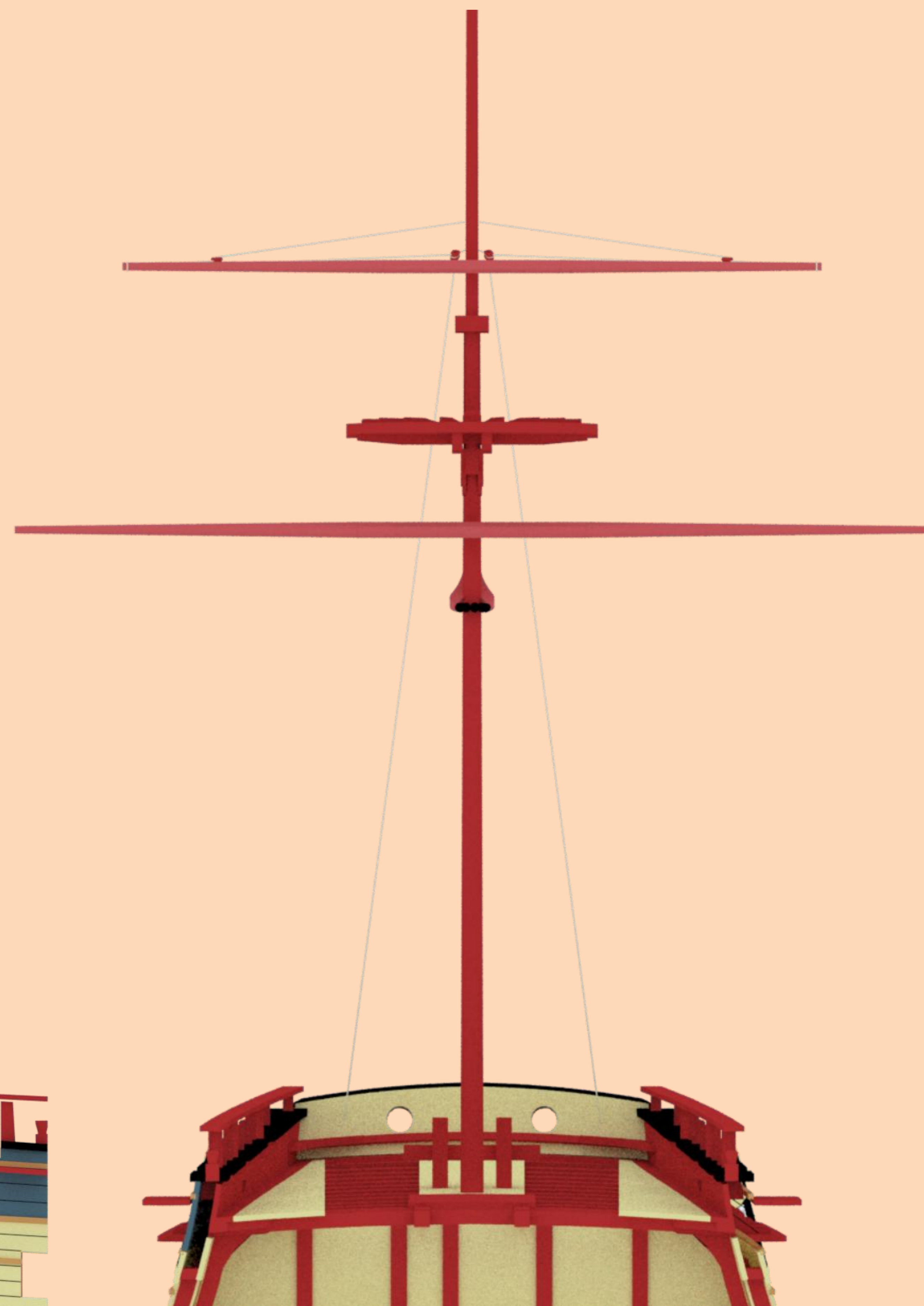
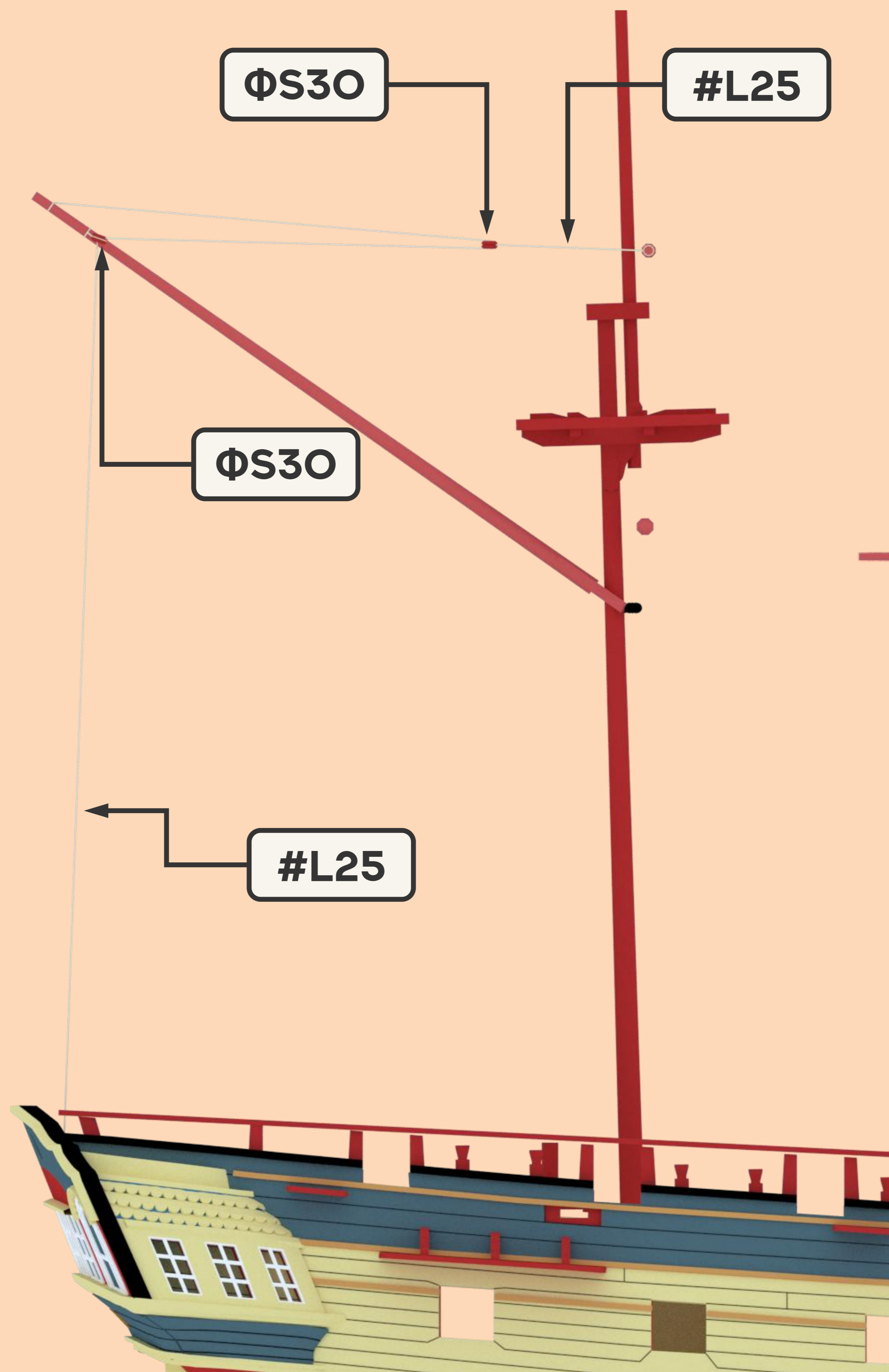
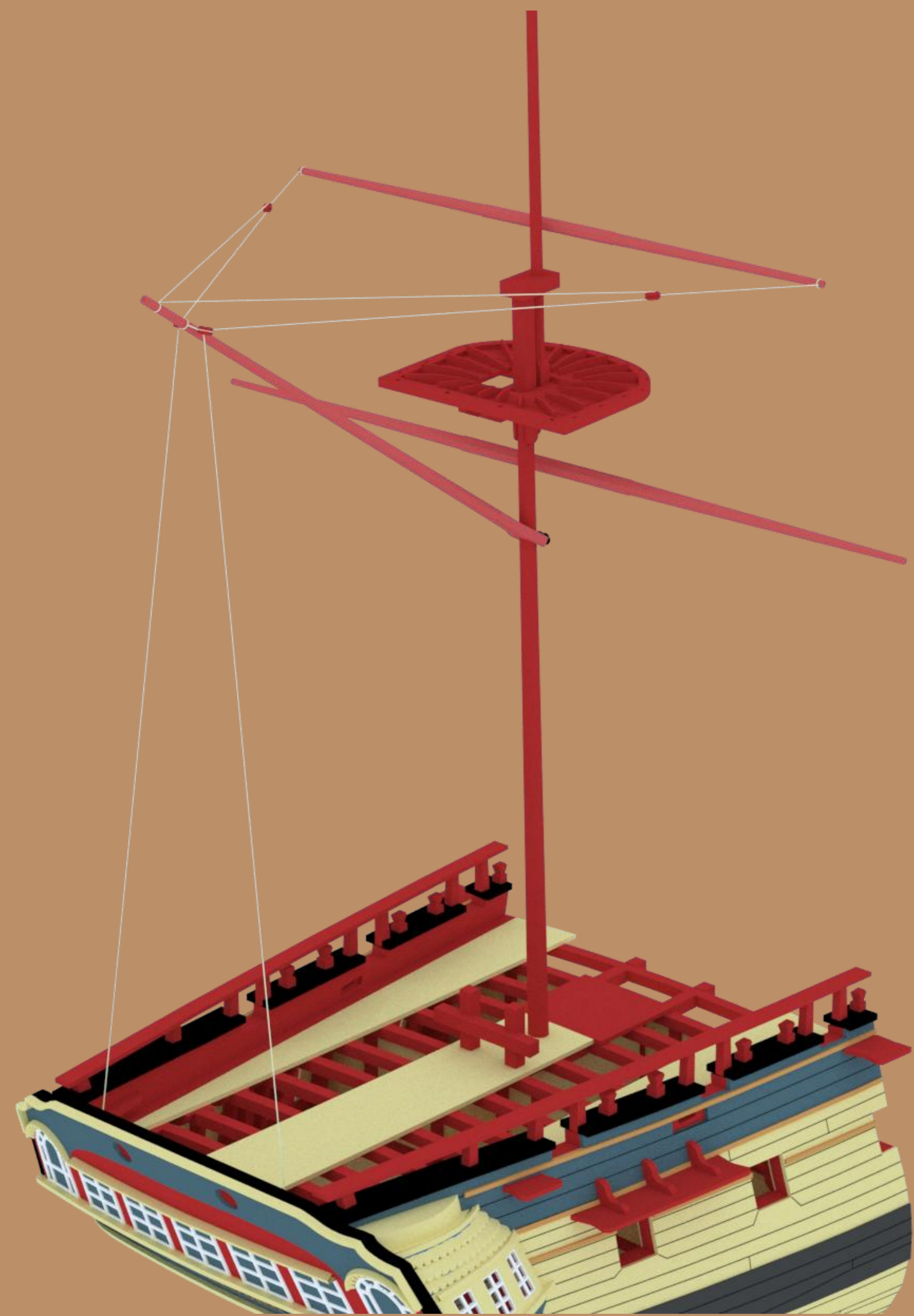

# 43. FORE TOPGALLANT BARCES

## DETAILS

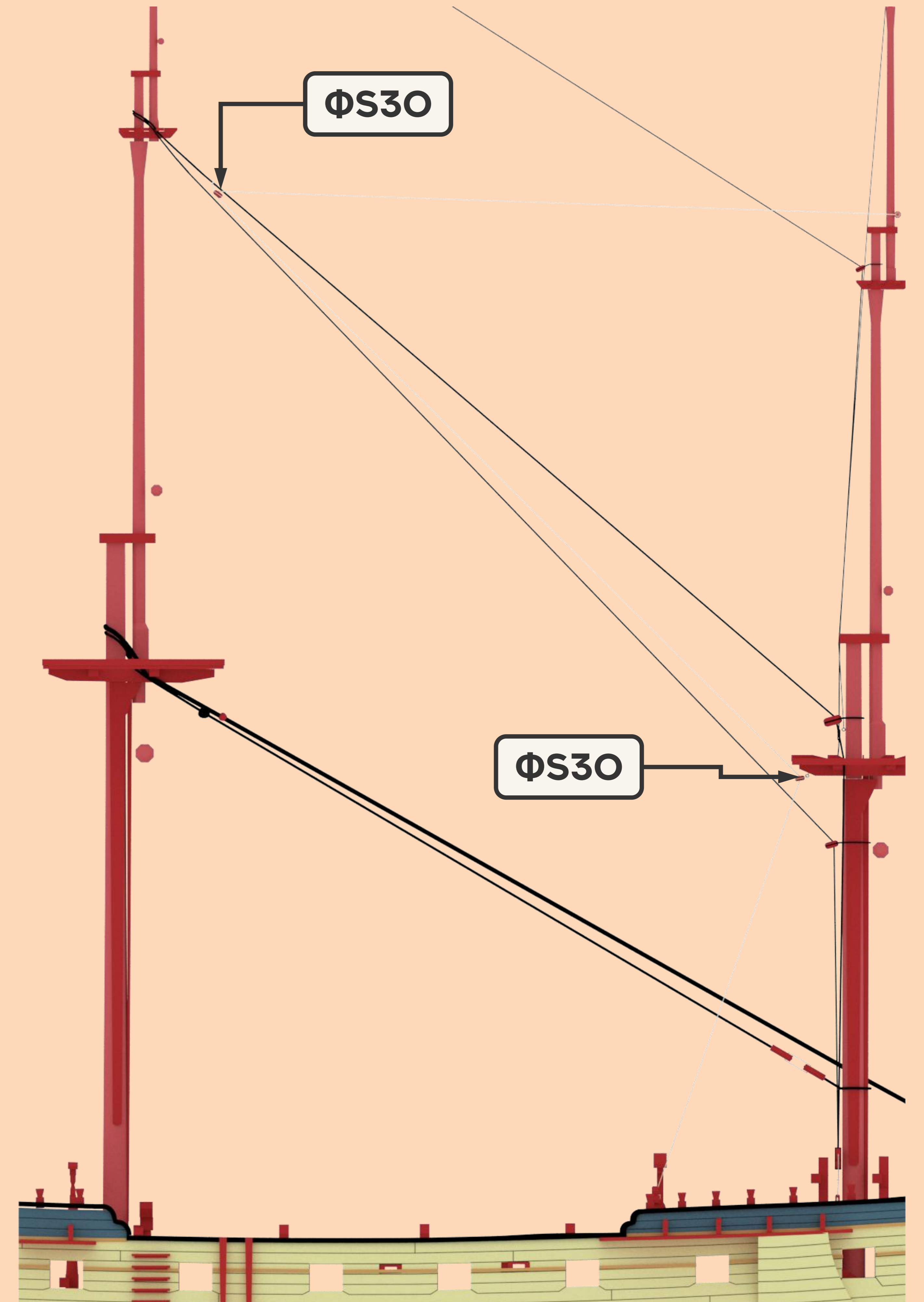
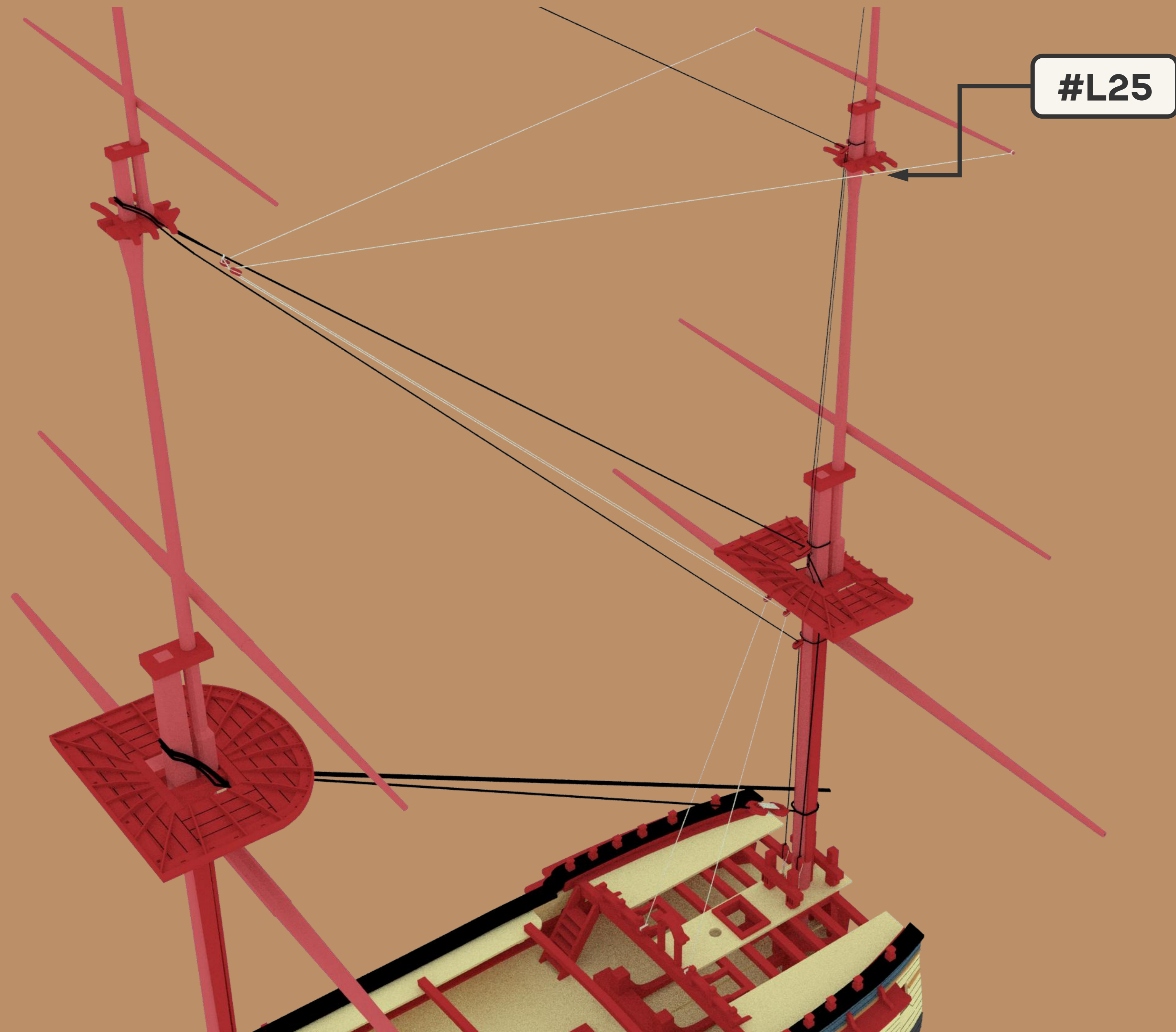



# 43. MAIN TOPGALLANT BARCES

## DETAILS

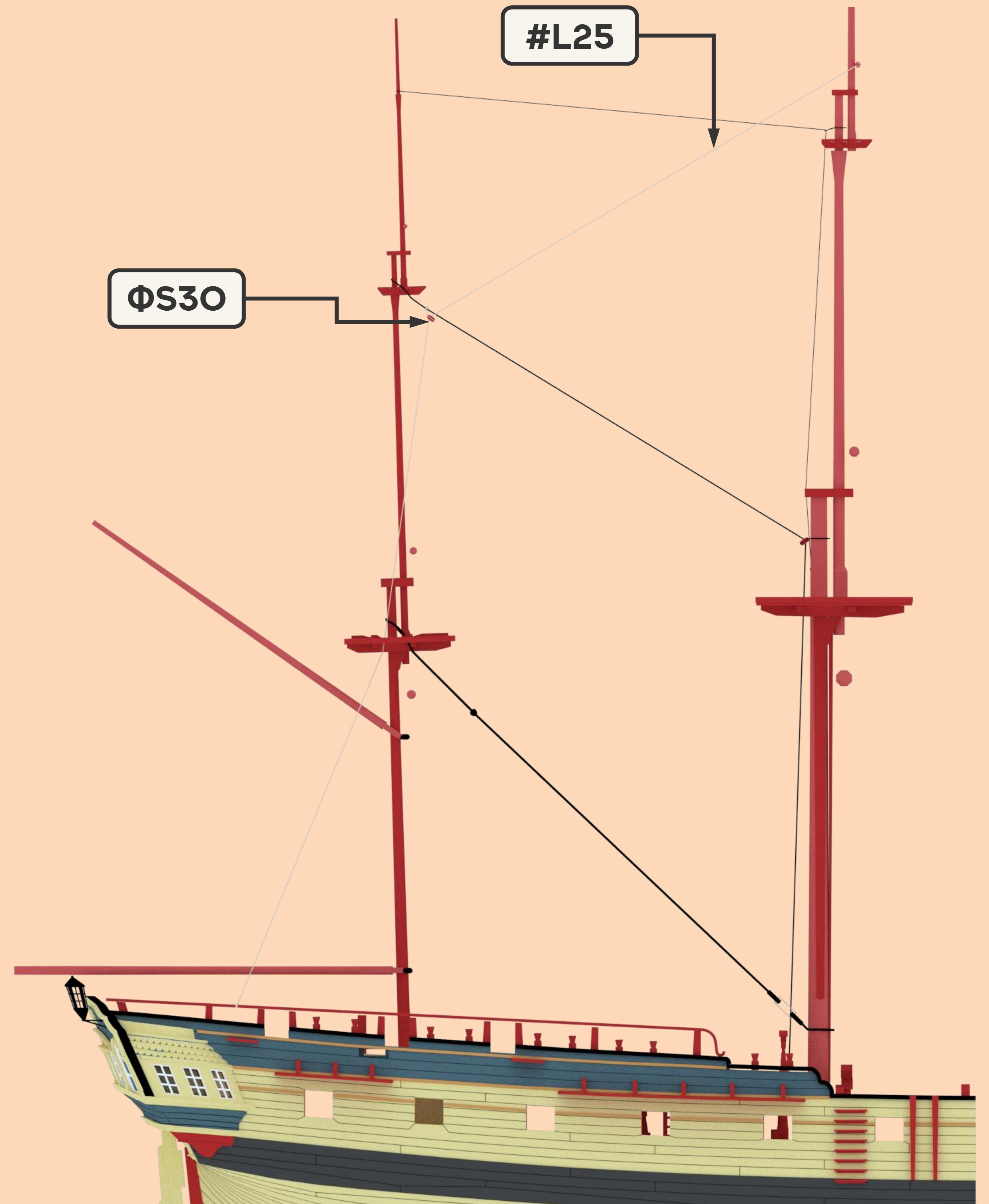
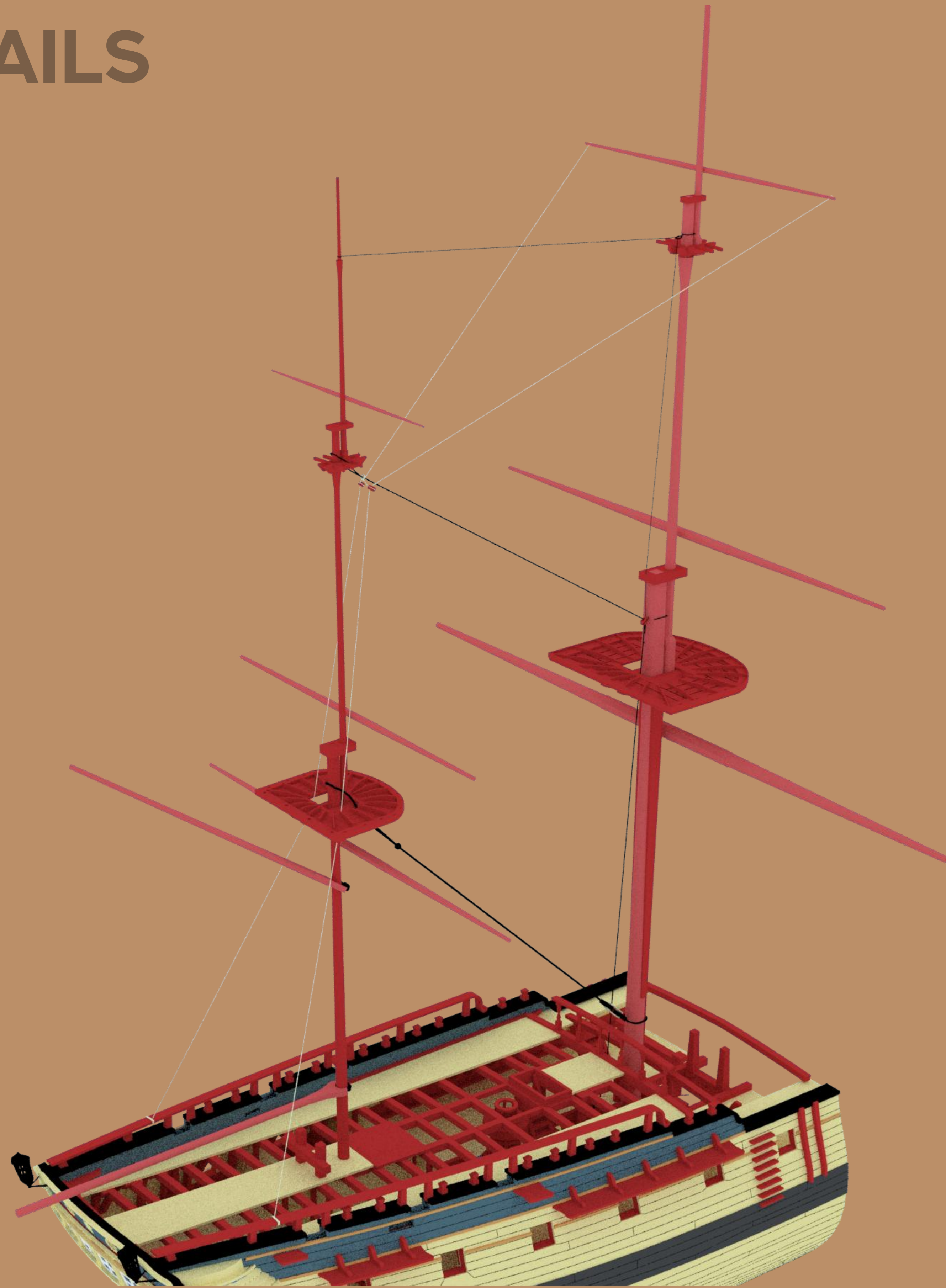

# 43. MIZZEN TOPGALLANT BARCES

## DETAILS

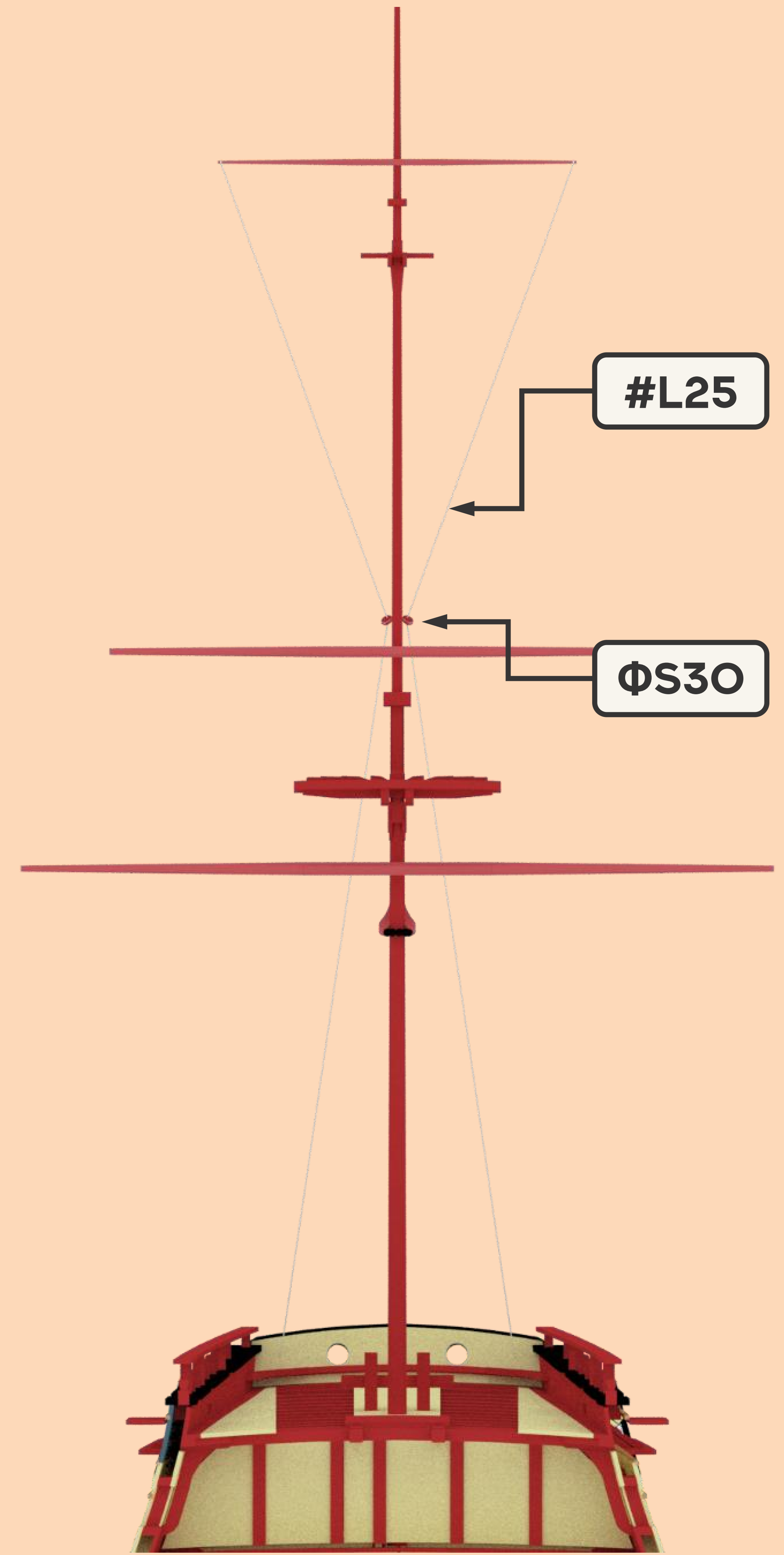
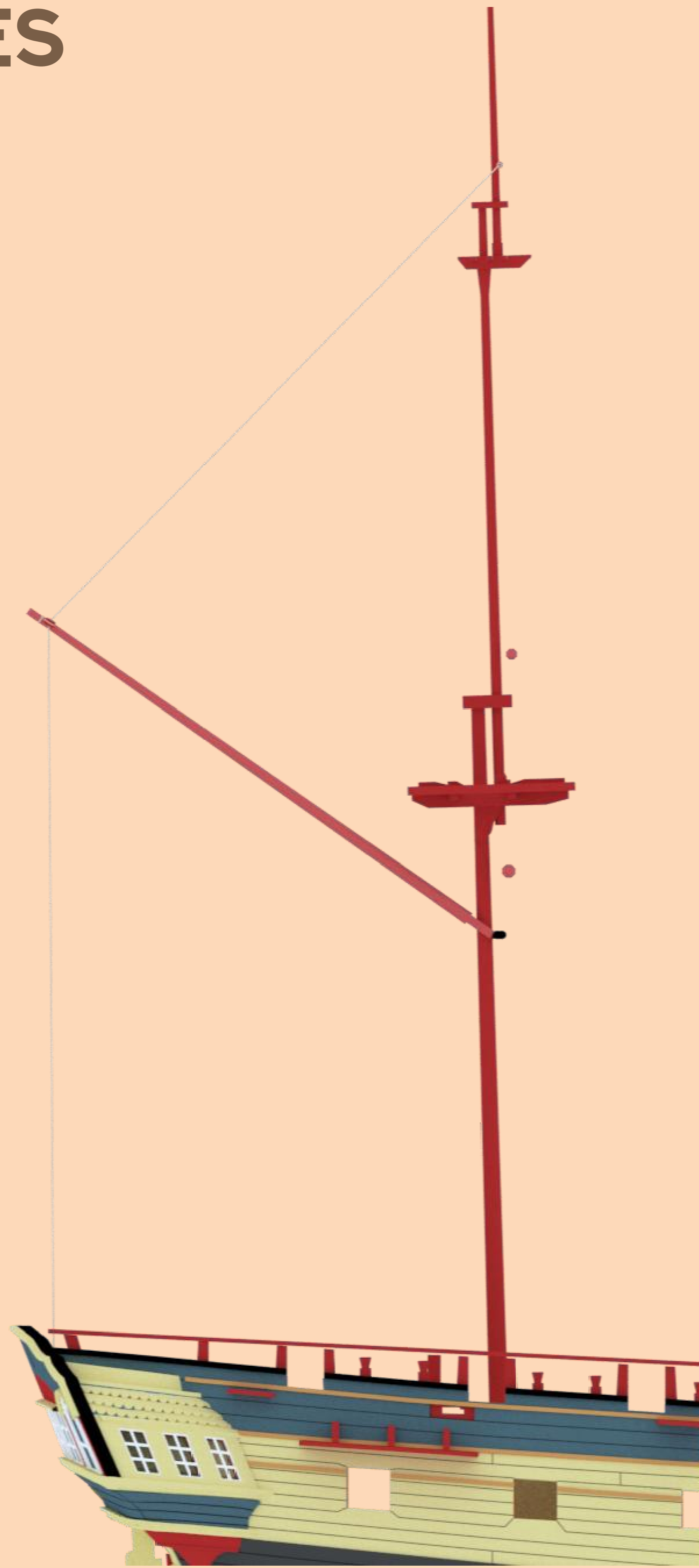
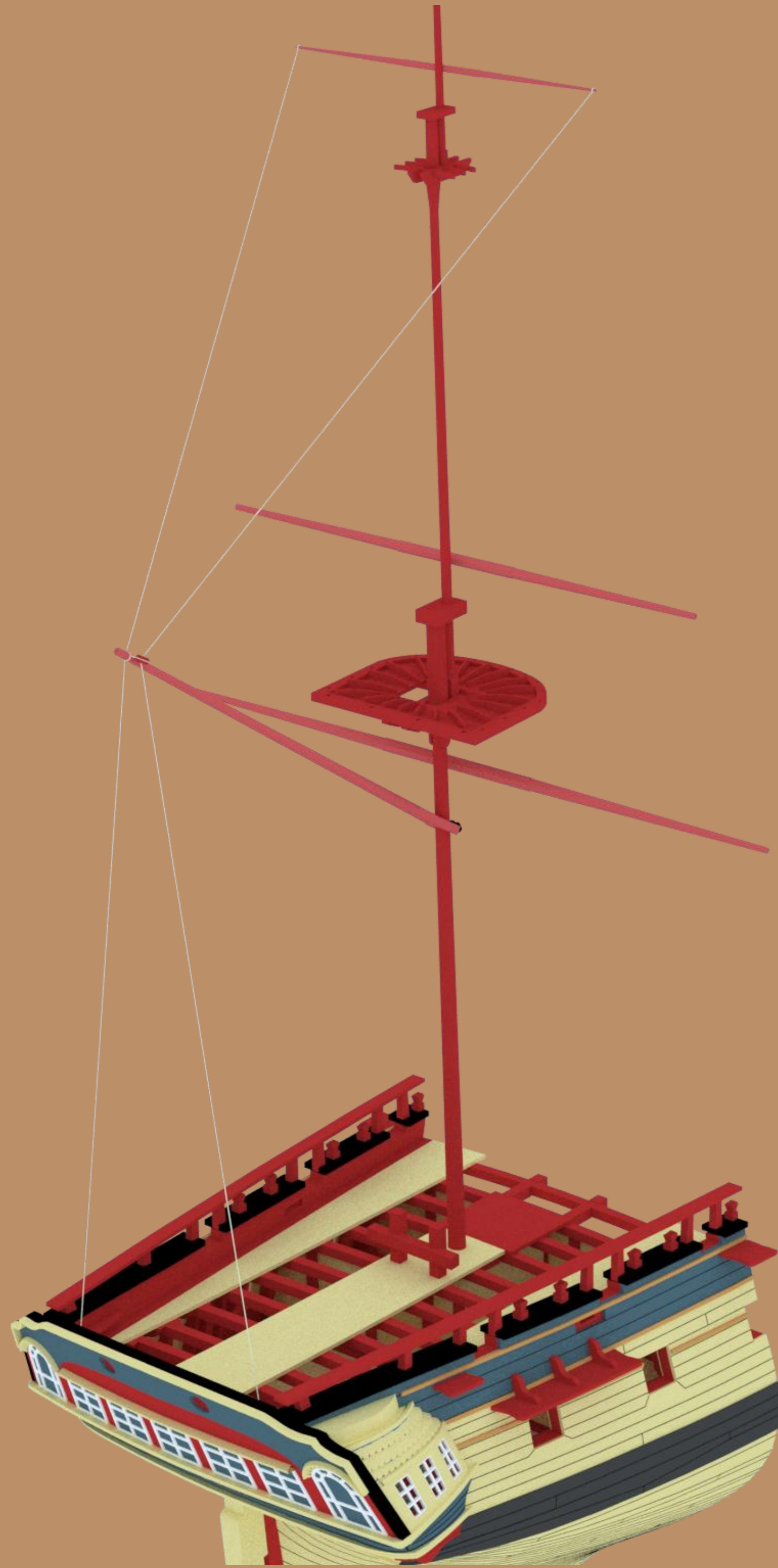

# 43. SPRITSAIL BARCES

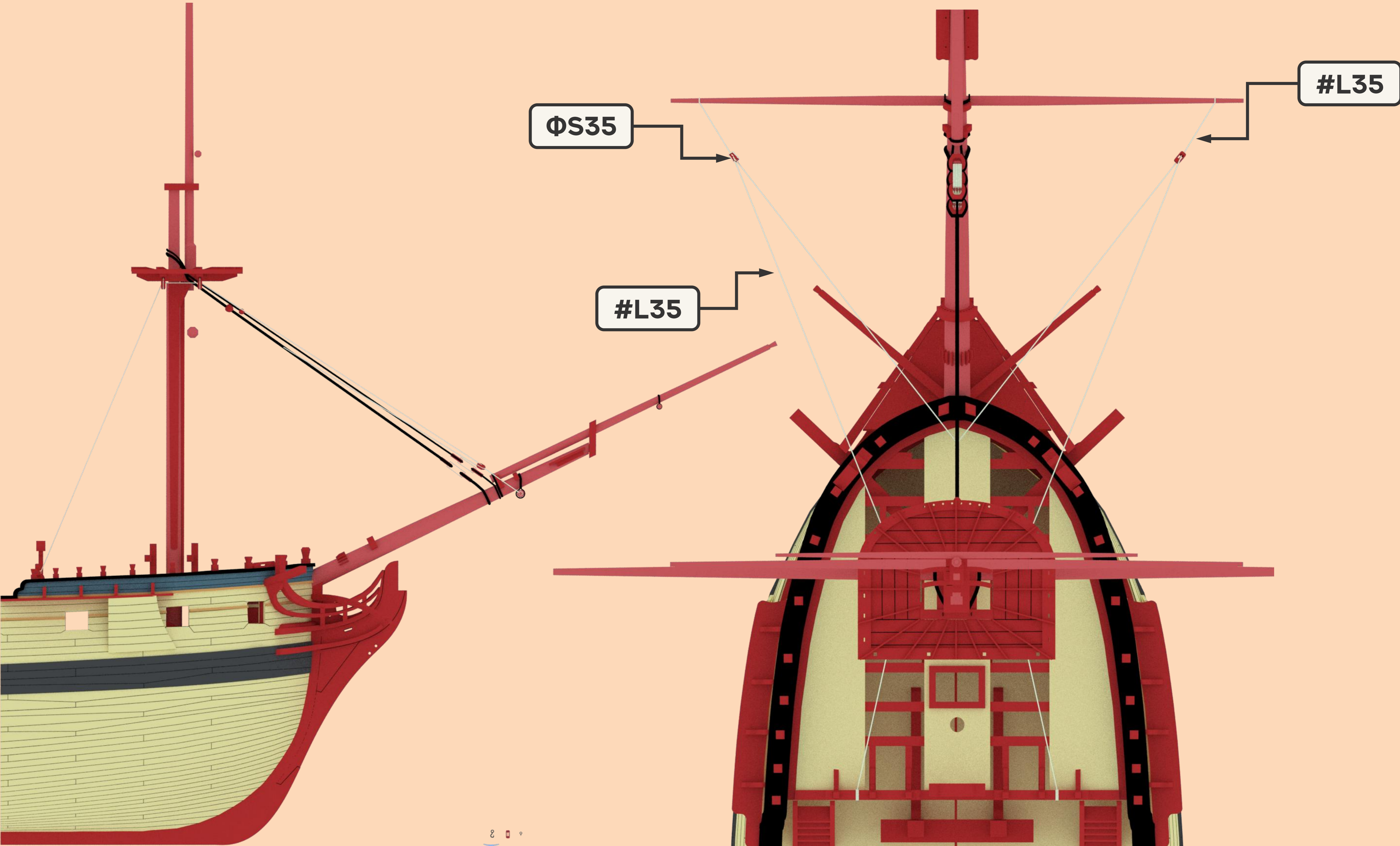

# 43. SPRITSAIL BARCES

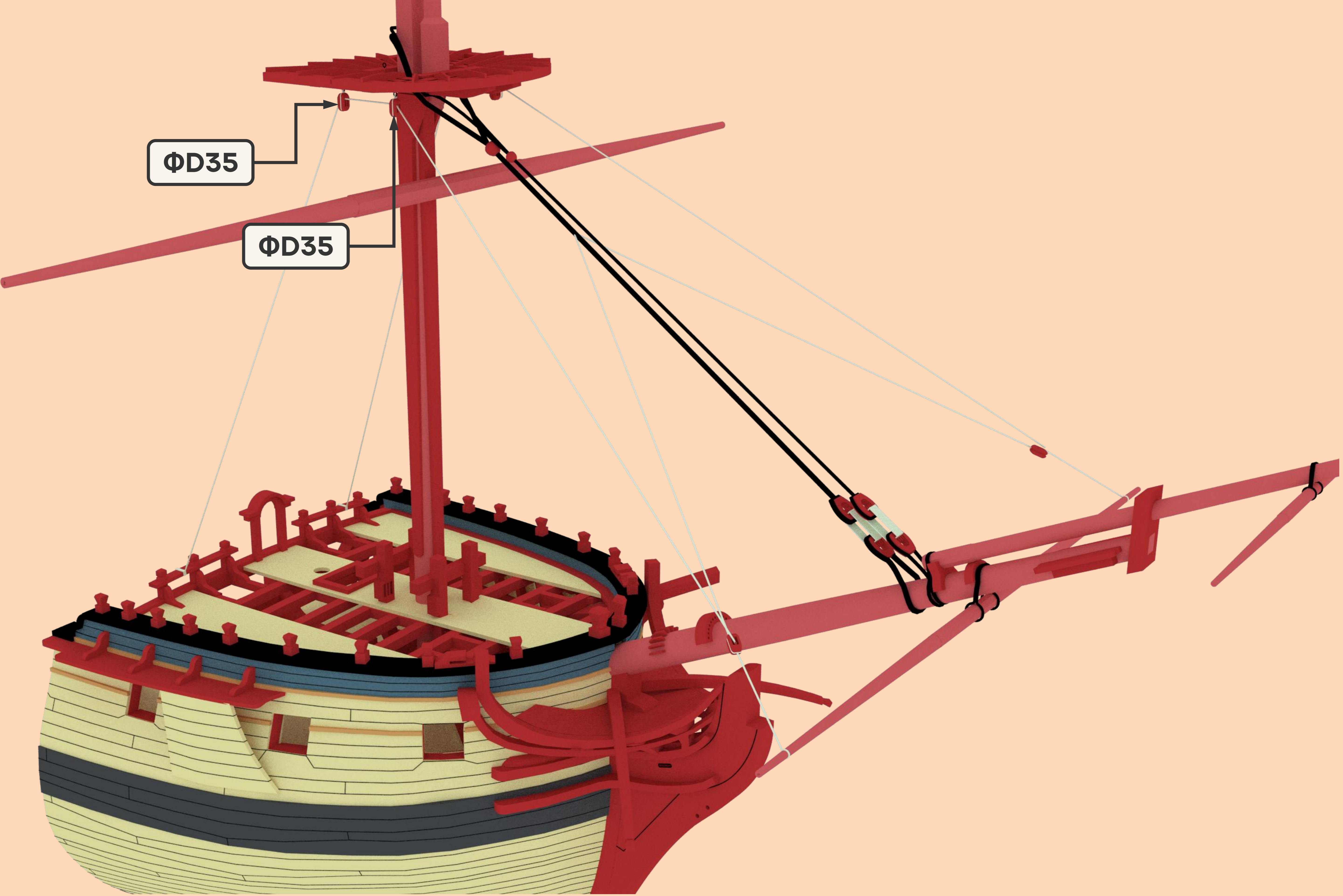

# 43. SPRITSAIL TOPSAIL BARCES

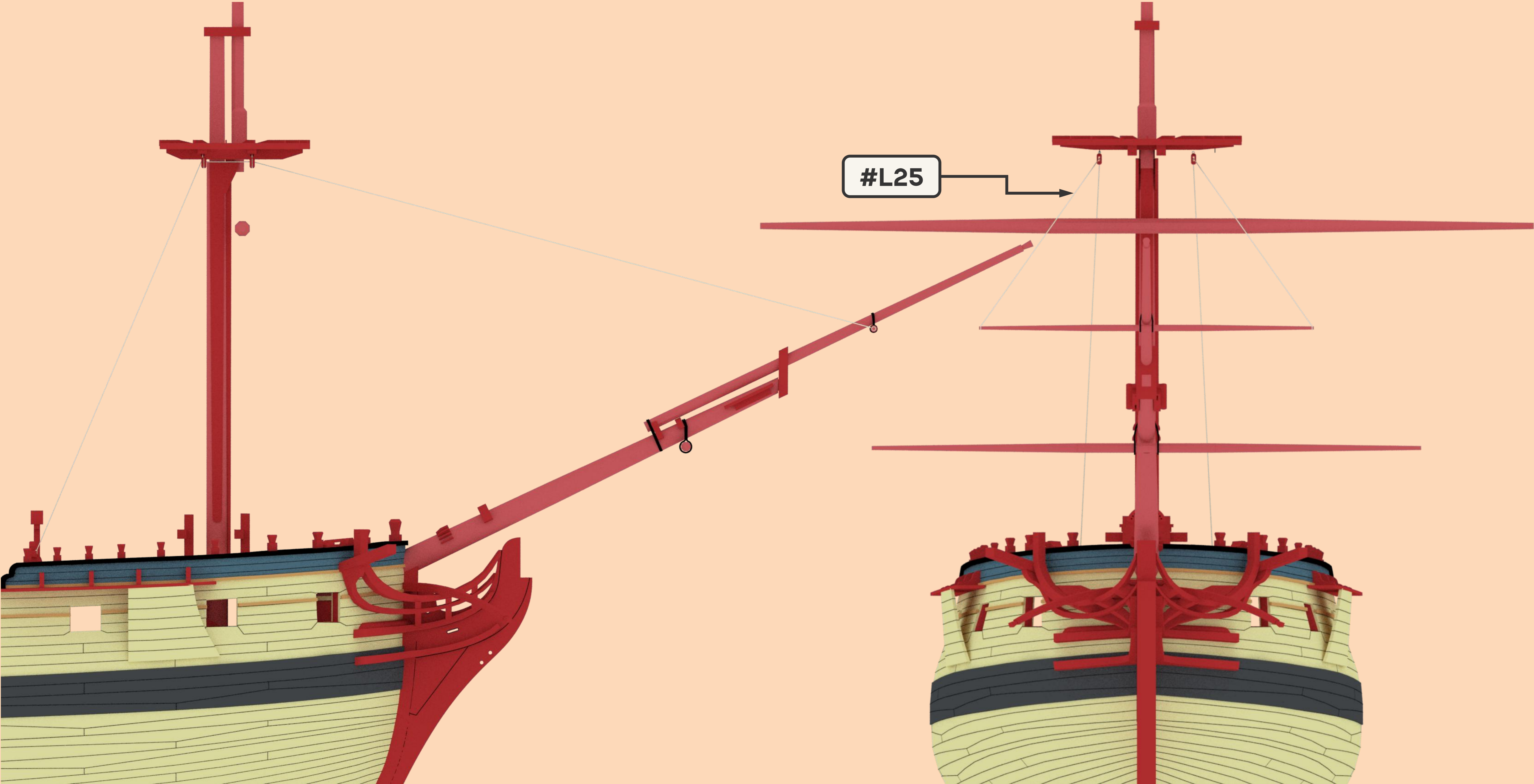

# 43. SPRITSAIL TOPSAIL BARCES

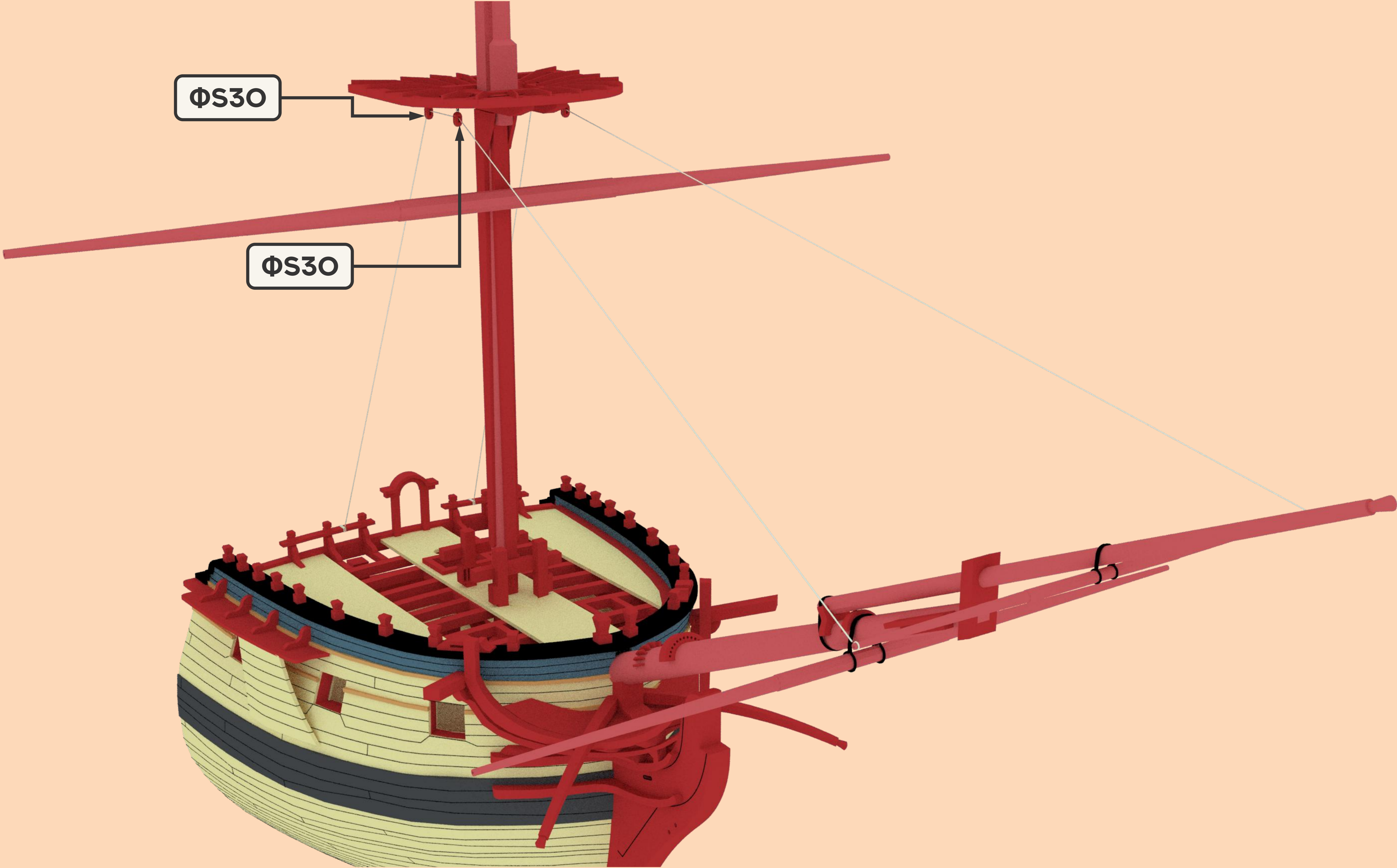

# STEP 40-60

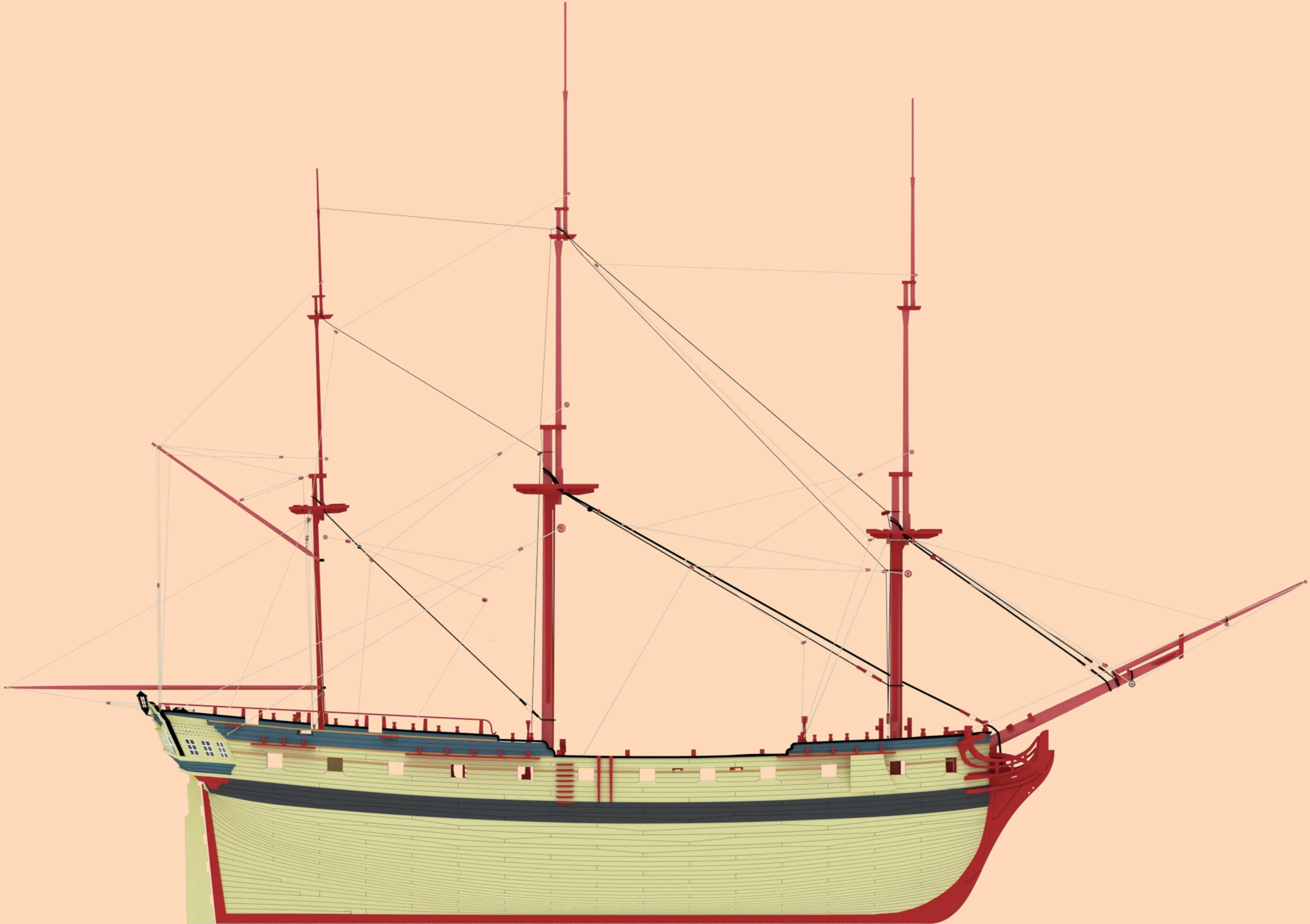

# FINISHED





# 色卡

